

Electric Built-in Oven

LBMFMX17



Contents

Safety Warnings	4
Unpacking	6
Installation	7
Installing the Built-in Oven	8
Making an Electrical Connection	9
Terminal Box Connections	9
Product Overview	10
Front View	10
Control Panel.....	10
Setting The Clock	11
First Time Use of the Oven/Grill	12
Thermostat Control	12
Using the Oven	13
Replacing the Anti-tilting Oven Shelf	13
Using the Functions and Temperature Controls	14
Automatic cooking	15
- Setting the cooking finish time.....	15
- Setting the cooking duration.....	15
Semi-automatic cooking	16
- Setting the cooking time.....	16
Manual cooking	16
Setting an alarm	17
- Cancelling/adjusting an alarm.....	17
Baking Tips	18
Energy Saving	18
Cleaning Tips	19
Cleaning the Outside of the Oven	19
Cleaning the Oven Door Glass	19
Replacing the Oven Lamp	20
Door Removal	20
Removing the Oven Door Glass for Cleaning	21
Energy Saving Tips and Energy Label	22
- Oven.....	22
Product Fiche and Specifications	23

Safety Warnings

IMPORTANT SAFETY INSTRUCTIONS READ CAREFULLY AND KEEP FOR FUTURE REFERENCE

- It is recommended that this appliance is installed by a qualified electrical engineer. The manufacturer is not responsible for any damage caused by incorrect installation.
- Check whether there is any damage to the appliance after you have unpacked it. If any damage is found, do not use the appliance and contact the store where you purchased it.
- This appliance is for Domestic Use only.
- For disconnection from the mains supply you must have a switch with a contact separation of at least 3.0 mm in all poles and suitably rated that provides full disconnection, this must be incorporated in the fixed wiring in accordance with the local wiring rules.
- If your mains cable gets damaged, it should be replaced by an authorized service agent or qualified electrician in order to avoid a hazard.
- Only operate your appliance in a dry atmosphere.
- Ensure that the appliance is switched off at the mains supply switch and allowed it to completely cool down before cleaning, replacing the oven lamp or performing any maintenance to avoid the possibility of an electric shock.
- This appliance can be used by children aged from 8 years and above and persons with reduced physical, sensory or mental capabilities or lack of experience and knowledge if they have been given supervision or instruction concerning use of the appliance in a safe way and understand the hazards involved.
- Children shall not play with the appliance.
- Cleaning and user maintenance shall not be made by children without supervision.
- Children should be supervised to ensure that they do not play with the appliance.
- During use the appliance becomes hot. Care should be taken to avoid touching the heating elements inside the oven.

- The appliance and its accessible parts become hot during use. Young children should be kept away.
- Danger of fire: Do not store items in the oven other than the accessories supplied.
- When the oven is hot never touch the oven glass or any other parts that get hot. Allow the oven to cool before touching these parts.
- Do not use harsh abrasives cleaners or sharp metal scrapers to clean the oven door glass since they can scratch the surface, which may result in the glass shattering.
- Before starting to use your appliance, keep curtains, tulle, paper or flammable materials away from your appliance. Do not keep combustible or flammable things in or on the appliance.
- This appliance is for cooking purposes only. It must not be used for other purposes, for example room heating.
- Do not use steam cleaners for cleaning the appliance.
- Do not rest any items on or stand on the open door.
- Oven handle is not a towel dryer. Do not hang up towels, gloves, or similar textile products when using the appliance.
- Take care when handling parts with glass, knocks, chips, heavy handling and dropping could cause the glass to shatter.
- The glass oven door uses toughened glass and is designed to break into many 'nugget' size pieces if it breaks. These pieces will still have sharp edges, please handle broken glass with care.

Thank you for purchasing your new Logik Electric Built-in Oven.

You must read this manual in order to fully understand how to install and operate it correctly. Read all the safety warnings carefully before use and keep this manual for future reference.

Unpacking

Remove all packaging from the unit. Retain the packaging. If you dispose of it please do so according to local regulations.

The following items are included:

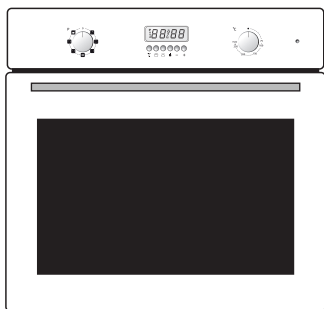

The Main Unit

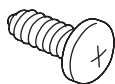

Fixing Screws x 2

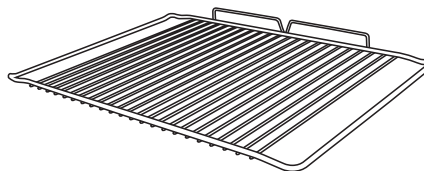

Oven Shelf x 2

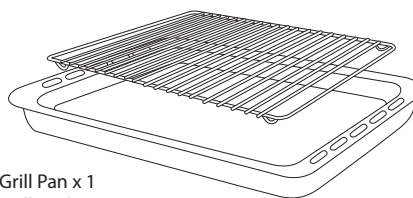

Grill Pan x 1
Grill Rack x 1



If items are missing or damaged please contact Partmaster (UK only).
Tel: 0344 800 3456 for assistance.

* All images are for indication only; please refer to your individual unit for actual item.

Installation



- The electrical connection of this oven should be carried out by a qualified electrician. Following the instructions in the installation section of this manual and in compliance with the current regulations.
- The oven is intended for household use only.

- This oven must be installed in compliance with local safety regulations.
- Wiring connections must be in accordance with Local Wiring Rules and any particular conditions of the local authority.
- Refer to the data plate for rating information. The data plate is positioned at the rear of the oven. The wiring diagram is positioned on the rear panel of the appliance.
- A means of disconnection with a contact separation of at least 3mm must be supplied in the fixed wiring. If this does not exist a qualified electrician will need to fit one.
- This appliance must be properly earthed.
- Do not lift the appliance by the door handles.
- Prepare the cupboard opening to match your appliance measurements. (See diagrams)
- Slide appliance into the cupboard, ensuring that the mains cable (where fitted) does not kink.
- To prevent tipping, secure your oven into the cupboard by fastening with the 2 screws supplied.
- The cabinet must be suitable for use with built-in ovens and capable of withstanding 100°C. Installation into low temperature tolerant cabinetry (e.g. Vinyl coated) may result in deterioration of the low temperature coating by discolouring or bubbling.
- Ensure the cabinet is rated at a temperature suitable for built in ovens. We cannot accept responsibility for damage caused by installation into low temperature tolerant cabinets.
- After installation, test and ensure that the appliance operates correctly.



To avoid any potential hazard, you must follow these instructions when you install your appliance.

Installing the Built-in Oven

1. The space where the oven will be placed needs to be at least 560mm wide, 550mm deep and 600mm high. A minimum gap of 2.5cm between the work surface and the control panel, and a distance of 5cm between the work surface and top of the oven is needed, in order to be able to get to the back of the oven if necessary and for easy access when sliding the oven out.

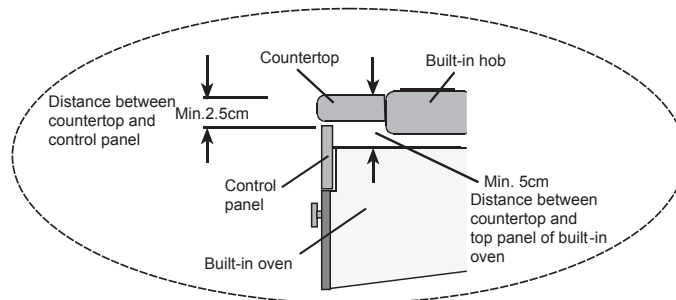
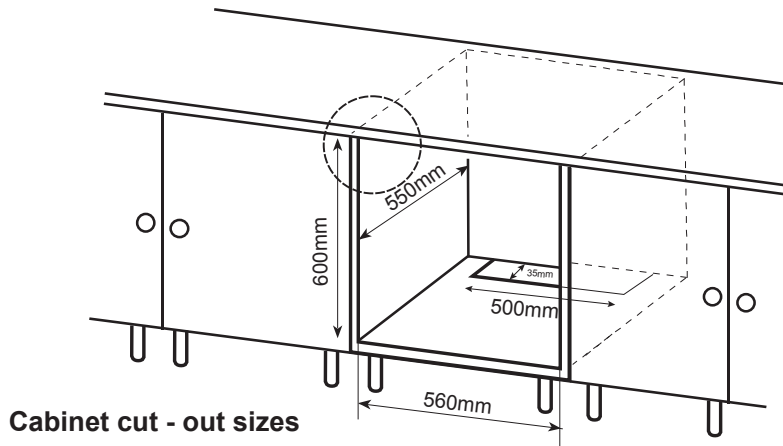

2. Ensure the electrical connections have been made.
3. Once the oven has been positioned into the gap, the front frame of the oven can be secured to the surrounding kitchen unit using the mounting screws.

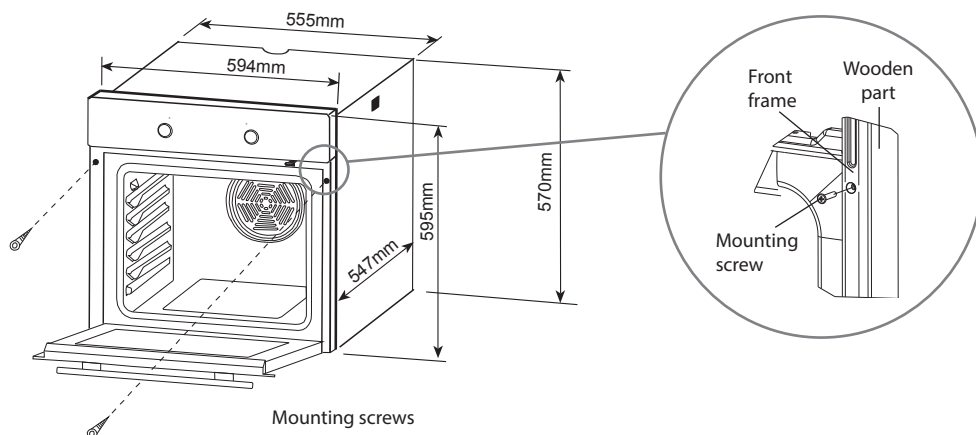

Insert the oven into the cabinet by pushing it back into the space within the cabinet. Open the oven door and insert the screws into the holes located on the oven frame. While the product frame touches the wooden surface of cabinet, tighten the screws.

Making an Electrical Connection

An approved suitable cable must be connected from the Consumer Unit (main fuse box) and be protected by its own 30amp fuse or Micro Circuit Breaker (MCB).

The electrician must provide a fused double-pole isolation switch, which disconnects both the line (live) and neutral conductors, with a contact separation of at least 3 mm incorporated into the fixed wiring. The 13A fused switch should be fitted to the kitchen wall, and must be placed in an easy accessible position in accordance with IEE regulations. Connect the fused switch to a junction box which should be fitted on the wall. The ovens power supply cable can then be connected. Connect one end to the junction box and connect the other end to the ovens power connection box which is located at the back of the oven. Remove the cover of the power connection box and install the cable, in accordance with the connection diagram. The power supply cable must be positioned away from direct heat sources. It should not be subjected to a temperature rise of more than 50°C above room temperature.

Terminal Box Connections

For this oven, the cable type must be a minimum of H05VV-F (PVC insulated and sheathed) 3 cores x 1.5mm² and the connection should be made as detailed below.

This appliance must be earthed

- Green / Yellow (Earth) to the PE (⊕) terminal
- Brown (Live) wire to the terminal marked L
- Blue (Neutral) wire to the terminal marked N

Ensure the cable exits through the cable grip clamping on the outer sheath of the cable and fix in place by tightening the fixing screw.

Ensure all screws are adequately tightened.
Do not over tighten as you may risk damaging the screw threads.

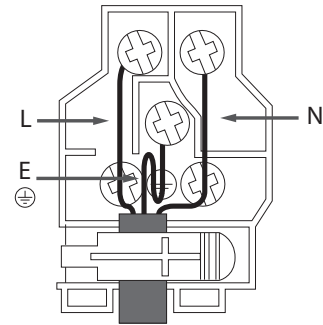
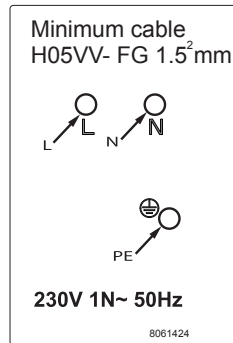

Grounding lead must be connected to screw with ⊕ symbol.

* All images are for indication only; please refer to your individual unit for actual item.

Product Overview

Front View

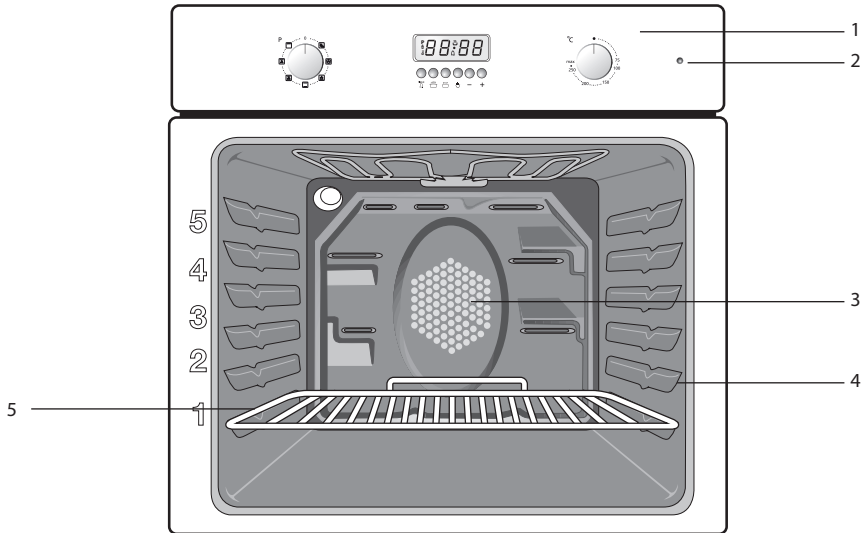

- | | | |
|--------------------|----------------------|-----------------|
| 1. Control Panel | 3. Fan | 5. Oven shelves |
| 2. Thermostat Lamp | 4. Shelf guide slots | |

Control Panel

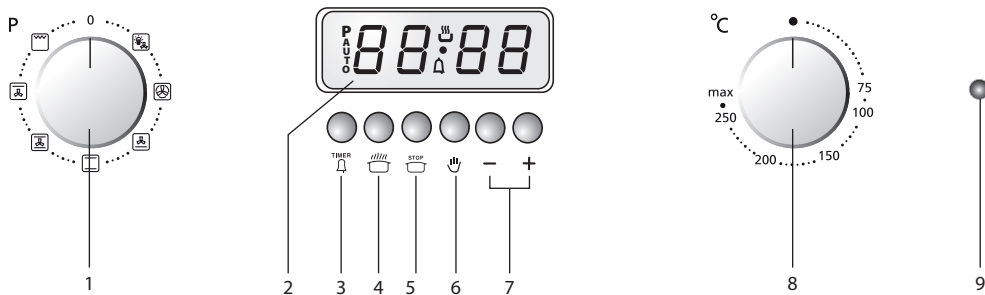



- | | |
|-------------------------------|---------------------------|
| 1. Function Selector Control | 6. Manual Cooking Button |
| 2. Oven Display | 7. Adjustment Buttons +/- |
| 3. Timer Button | 8. Thermostat Control |
| 4. Cooking Time button | 9. Thermostat Lamp |
| 5. End of Cooking Time button | |

* All images are for indication only; please refer to your individual unit for actual item.

Setting The Clock



Before you can use the oven the time must be set. If the time is not set you're oven will NOT operate.

1. When the power is first switched on the clock will flash. Press and hold the   buttons together.



The clock is a 24 hour clock.

2. While holding down the   buttons press the +/- buttons to adjust the time. A single press will adjust the time 1 minute per press, or hold the +/- buttons down to increase the time quickly.

3. Once you have selected the correct time release the   buttons, the clock will stop flash and the time will now be set.

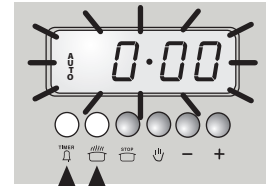

Press and hold

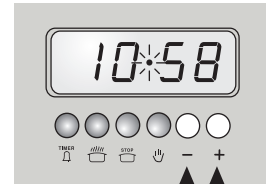

Press



Release the buttons

First Time Use of the Oven/Grill

- Unpack the oven. Remove any insert cards or plastic bags. Use a damp cloth to carefully wipe the inner cavity wall and housing. Clean all the detachable parts in hot, soapy water before using.
- Ensure the appliance is installed correctly before turning it on.
- Heat the appliance on maximum, making sure the room is well ventilated as there may be a little smoke and odour. This is normal, and is due to the protective substance on the appliance which protects it during shipping from the factory. Switch the appliance off once the smoke and odour has stopped. This can take up to 30 minutes.

Thermostat Control

The temperature can be set from 50°C - 250°C (Max). Select the desired temperature, as follows:

To keep food warm	75 - 100°C position
For traditional oven cooking	75 - 250°C (Max) position
For all types of grilling	200°C position

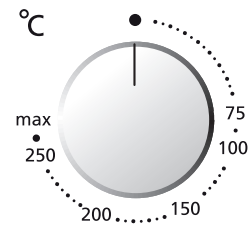

* All images are for indication only; please refer to your individual unit for actual item.

Using the Oven



- Under no circumstances should the oven be lined with aluminium foil as overheating may occur.
- Do not place dishes or baking trays directly onto the base of the oven as it becomes very hot and damage may occur.
- Bread may catch fire if the toasting time is too long. Close supervision is necessary during toasting.
- During use, this appliance becomes hot. Care should be taken to avoid touching hot surfaces, e.g., oven door, heating elements.
- Accessible parts may become hot when in use. Children should be kept away.



The clock must be set to use the oven.

- To get the best results, the smallest distance allowed between the food and the upper heating element is 30mm.
- On the wall of inner cavity there are 5 different shelf guide slots in the main oven. You can place the shelf at different heights to achieve the best cooking performance depending on the heat of the heating elements and the size of food. If only the upper heating element is on, we suggest that you place the shelf on guide 5 (ensure a minimum distance of 30mm between the food and the upper heating element).
- Always monitor the food during cooking to ensure that you are not overcooking it.
- For heavy food, use an oven tray (supplied) rather than the wire shelf.
- Select the oven function you require. Select the temperature you require.
- Before placing food in the oven you may need to pre-heat the oven for 10 minutes.
- The temperature light will go out when the chosen temperature has been reached.
- To switch the oven off turn the function control dial to the off position '0'.

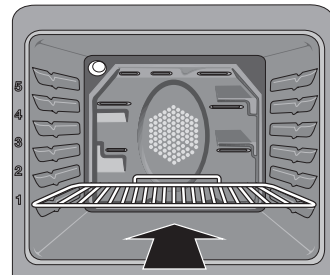

Using the grill





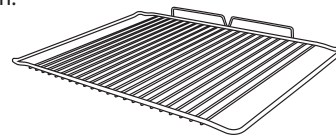

- Pre-heat the grill to 200°C.
- Place the grill pan on an oven shelf, the smallest distance allowed between the food and the grill element is 30mm.
- When using the grill close the door. Do not leave unattended whilst grilling.
- Oven gloves must be used when removing the grill pan.

Replacing the Anti-tilting Oven Shelf

- Insert the shelf at an angle with the vertical section to the rear to clear the stops at either side of the guide slot. Once past this stop the shelf can be placed level again.
- To remove, completely angle the shelf upward so the shelf stop is cleared from the guide stop.



Using the Functions and Temperature Controls

Symbol	Function Description
	<p>Oven Light and Fan</p> <p>The oven light and fan will be turned on. No heating will take place. This is an ideal setting for defrosting food.</p>
	<p>Fan Heating</p> <p>Warm air heated by the rear heater is evenly distributed throughout the oven rapidly by means of the fan. It is suitable for cooking your meals in different rack levels and preheating is not required in most cases. Suitable for cooking with multi trays.</p>
	<p>Fan with Bottom heating</p> <p>Bottom heating and the fan (in the rear wall) are in operation. Hot air is distributed better with fan when compared to the situation where only bottom heating is in operation.</p>
	<p>Top and Bottom heating</p> <p>Top and bottom heating are in operation. Food is heated simultaneously from the top and bottom. For example, it is suitable for cakes, pastries, or cakes and casseroles in baking moulds. Cook with one tray only.</p>
	<p>Fan with Top and Bottom heating</p> <p>Top heating, bottom heating plus fan (in the rear wall) are in operation. Hot air is evenly distributed throughout the oven rapidly by means of the fan. Cook with one tray only.</p>
	<p>Fan with Top heating</p> <p>Top heating and the fan (in the rear wall) are in operation. Hot air is distributed better with fan when compared to the situation where only top heating is in operation.</p>
	<p>Grilling Function</p> <p>Large grill at the ceiling of the oven is in operation. It is suitable for grilling large amount of meat.</p> <ul style="list-style-type: none"> • Put big or medium-sized portions in correct rack position under the grill heater for grilling. • Set the temperature to 200°C. • Turn the food after half of the grilling time.

When using the oven function, first select the function using the Function dial, then set the temperature with the temperature dial. The thermostat light will illuminate. When the temperature inside your oven reaches the temperature you set, the thermostat will cut off the heating element and the thermostat light will go off. When the temperature falls below the set temperature, the heating element will again be turned on and the thermostat light will illuminate.

Automatic cooking

The automatic cooking mode lets you set your oven to cook your meal so its ready for when you require. Remember your clock needs to be set correctly for this cooking mode to work properly.

1. Place your dish into the oven.



Setting the cooking finish time

Set the time that you would like your cooking to be finished.

2. Press and hold the  button.



Press and hold

3. While holding the  button down press the +/- buttons to set the time you would like your cooking to finish.
4. Release the  button.

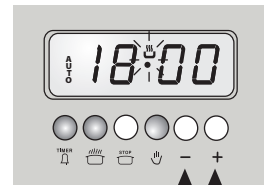

Press to set cooking end time



Setting the cooking duration

Now you need to set the cooking duration, your oven will automatically set the maximum cooking time from the cooking finish time.

5. Press and hold the  button.



Press and hold

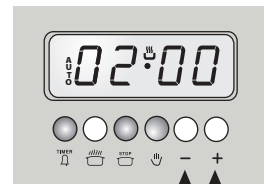

6. While holding the  button down press the +/- buttons to set the cooking duration.
7. Release the  button.
8. Select the cooking function and temperature. Your oven will now switch on and start cooking at the time you selected.



Press to set cooking duration



You may wish to add a few extra minutes to the cooking time as your cooking time includes the time needed for the oven to heat up to temperature.

9. The alarm will sound when your oven has finished cooking. Press the  button to switch the alarm off and turn the function dial to '0' and the temperature dial to . The word AUTO will remain flashing in the display.



To clear the Automatic cooking mode press the  button.

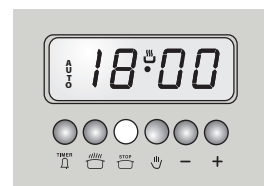

Semi-automatic cooking

The semi-automatic cooking mode lets you set the cooking time, it will then switch off after the time set. Cooking will start from the minute the cooking time is set. Remember your clock needs to be set correctly for this cooking mode to work properly.

1. Place your dish into the oven.
2. Set your desired function and temperature.

Setting the cooking time

Set the time that you would like to cook for.

3. Press the  button.

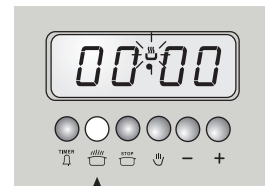

Press

4. Press the +/- buttons to set the cooking time. The maximum cooking time is 23hours 59 minutes. The oven will switch on as soon as the time has been set.

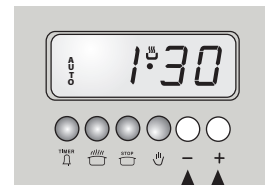

Press to set cooking time



If you want to see the cooking time remaining at any point, press the  button.

5. Once the cooking time has finished the alarm will sound, press  to switch the alarm off.

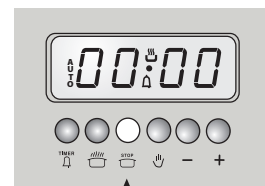

Press to switch alarm off

Manual cooking

If you just want to use your oven without setting a timer select manual cooking mode.

1. If the word AUTO is flashing in the display press the  button to select manual mode. If the word is not flashing then an automatic cooking program has been set, you will need to clear the program by setting the cooking time to 0:00.
2. Select the cooking function and temperature you desire and you oven with switch on.



Press



Setting an alarm

The clock on your oven can be used to set an alarm. The maximum alarm time is 23 hours 59 minutes.

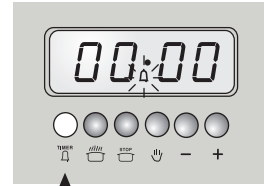
1. Press and hold the  button, 00.00 will be displayed.



Press and hold

2. While holding the  button press the +/- buttons to set your desired alarm time. The alarm will start to count down once you release the  button.

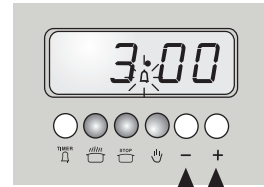

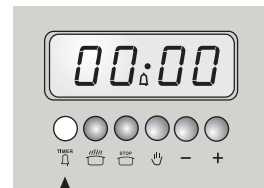

Press to set cooking duration

3. When the alarm sounds press the  button to switch the alarm off.



Press

Cancelling/adjusting an alarm

To cancel an alarm press and hold the  button then press the - button until the display shows 00.00. If you want to adjust the time press the +/- buttons while holding down the  button.

Baking Tips

- Always place baking tins in the centre of the wire shelf.
- Make sure you use bakeware that is oven proof.
- Do not place bakeware too close to the rear of the oven wall.
- You can influence the degree of browning by changing the temperature setting or by re-positioning the shelves closer to the top element if it is active.
- If a cake collapses after removing it from the oven:
 - Use less liquid on your next attempt.
 - Consider using a longer baking time or use a slightly lower temperature setting.

Energy Saving

To save energy and to help protect the environment, we recommend these hints:

- Preheat the oven only if expressly required by the recipe or guidelines.
- Dark baking tins have a higher degree of heat absorption.
- In the case of longer baking times, you can switch off the oven 5–10 minutes before the full baking time and use the residual heat. This will reduce energy usage.
- Use the oven efficiently, by cooking many trays of food at the same time.
- Select the correct shelf location for food being cooked.
- Do not open the oven door more than necessary.

* All images are for indication only; please refer to your individual unit for actual item.

Cleaning Tips



Ensure that the appliance is switched off and isolated before cleaning the oven to avoid the possibility of electric shock.

1. Allow the oven to fully cool before cleaning. Remove the wire shelves, wash them separately in hot soapy water and dry thoroughly.
2. Wash the interior of the oven with hot soapy water and wipe down with a damp cloth.
3. Leave the door partially open until the interior has dried before replacing the wire shelves.
4. Clean the oven after each use, especially after roasting or grilling, this will prevent spilt or splattered food debris burning and becoming difficult to remove.
5. Do not use abrasive pads to clean the interior of the oven as this may remove the enamel, which will affect the efficiency of your oven.
6. Steam cleaners must never be used to clean this oven.

Cleaning the Outside of the Oven

1. You should regularly wipe over the control panel and oven door using a soft cloth and liquid detergent as spilt liquids may damage the finish.
2. Wash enamelled or chrome plated parts of the oven with hot soapy water or non-abrasive detergents.
3. Never use abrasive pads to clean enamelled, chromed or stainless steel surfaces.
4. When using commercially available stainless steel cleaning products, avoid cleaning any lettering or symbols, as they can become damaged.

Cleaning the Oven Door Glass

Do not use harsh abrasive cleaners or sharp metal scrapers to clean the oven door glass since they scratch the surface, which may result in shattering of the glass.



Take care when handling parts with glass, knocks, chips, heavy handling and dropping could cause the glass to shatter.

Replacing the Oven Lamp



Ensure that the appliance is switched off before replacing the light to avoid the possibility of electric shock.

1. Turn off the oven and make sure that it is cold. Switch off its isolation switch.
2. Turn the bulb cover anti-clockwise to remove the cover. If your oven lamp is of type (A) shown in the figure below, remove it by rotating as shown and replace it. If it is of type (B), pull and remove it as shown in the figure and replace it.
3. Insert the new bulb, which should be resistant to 300°C. For replacement bulbs contact your local service centre or Partmaster Direct (details at the back of this guide).
4. Re-fit the cover by turning clockwise.
5. If in any doubt, consult a qualified electrician for help.

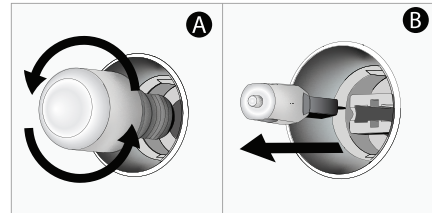
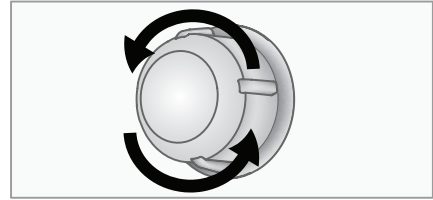

Bulb specifications

Bulb A - 230V~ 50 Hz, 25W, E14

Bulb B - 230V~ 50 Hz, 25W, G9

Door Removal



- Take care when handling parts with glass, knocks, chips, heavy handling and dropping could cause the glass to shatter.
- Allow the door to cool down before removing it.

It is possible to remove both oven doors. Follow the steps below to remove the door. This may be required if easier access to the cavity is required or if you wish to clean the door parts.

1. Fully open the door.
2. Press down on the hinge clips on the left and right of the door. You may need to use a pair of pliers as the clips can be stiff.
3. Open the door half way.
4. Pull the door upwards, the door will now release from the hinge.

To replace the door, repeat the above steps in reverse order. Ensure to locate the hinge correctly. Close the hinge clips on both sides of the door. If the door does not close properly, repeat the steps again.

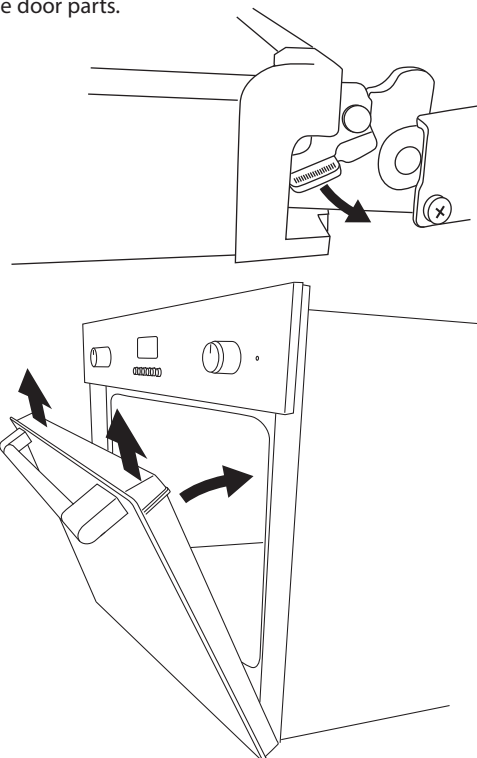

Removing the Oven Door Glass for Cleaning

1. Open the oven door.
2. Remove the plastic vent on top of the door by gently pulling at each end.

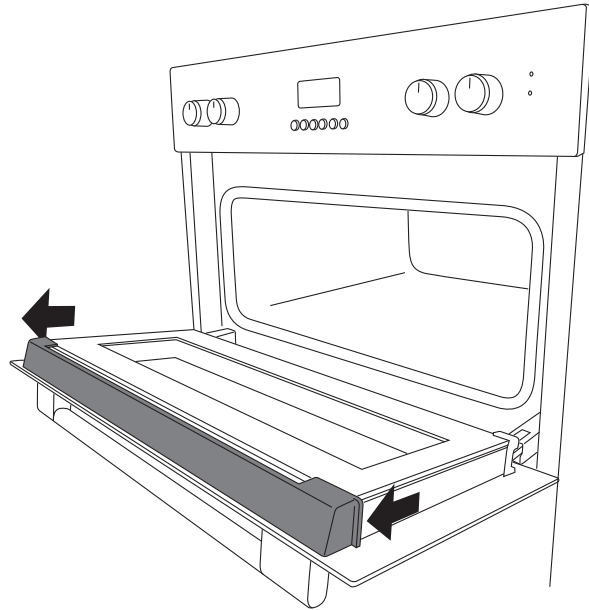

3. Carefully slide the glass out. Be aware that once the glass is removed the door may spring up.
4. When replacing the glass make sure you place it back with the painted side down. Slide the glass back into place and clip the plastic vent back on.

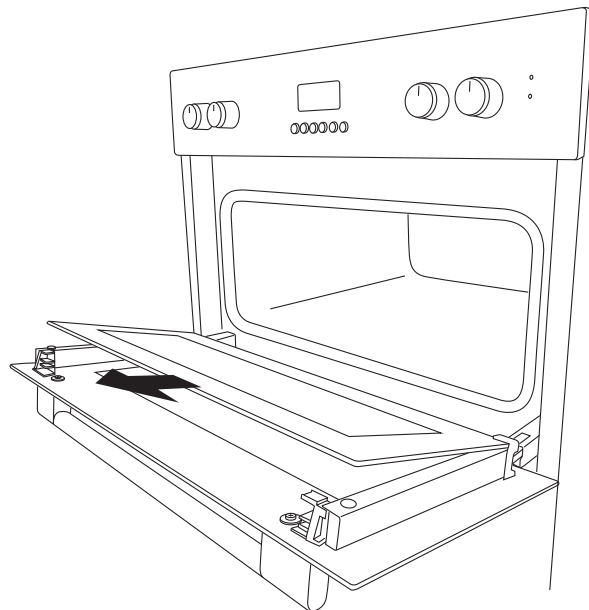

* All images are for indication only; please refer to your individual unit for actual item.

Energy Saving Tips and Energy Label

Oven

- Cook the meals together, if possible.
- Keep the pre-heating time short.
- Do not elongate cooking time.
- Do not forget to turn off the oven at the end of cooking.
- Do not open the oven door during cooking.

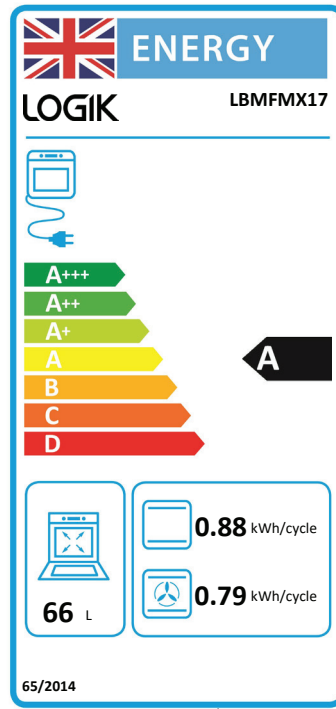
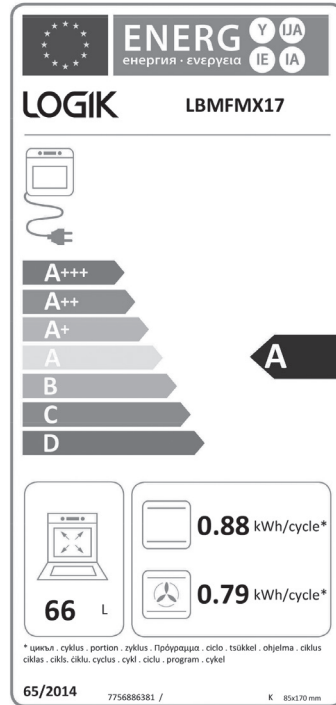

Product Fiche and Specifications

Brand	Logik
Model	LBMFMX17
Type of Oven	Electric
Mass	29.5 Kg
Energy Efficiency Index - Conventional	-
Energy Efficiency Index - Fan Forced	95.5
Energy Class	A
Energy Consumption (electricity) - Conventional	0.88 kWh/cycle
Energy Consumption (electricity) - Fan Forced	0.79 kWh/cycle
Number of cavities	1
Heat Source	Electric
Volume	66 litres
This product complies with	EN 60350-1
Overall Dimension (WxDxH)	594(W) x 547(D) x 595(H) mm
Supply Voltage	220V - 240V~ 50 Hz
Power (electricity)	2020-2400 W
Current	8.8 – 9.6 A
Grill	1850-2200 W
Fan	21 - 25 W

Features and specifications are subject to change without prior notice.

All the support you need.

Currys.co.uk

Whether it's a tech emergency or you need plain good advice, we're always on hand to help, call (UK) 0344 5611234 or (Ireland) 1 890 818 575.



Visit Partmaster.co.uk today for the easiest way to buy electrical spares and accessories. With over 1 million spares and accessories available we can deliver direct to your door the very next day.

Visit www.partmaster.co.uk or call 0344 800 3456 (UK customers only). Calls charged at National Rate.



The symbol on the product or its packaging indicates that this product must not be disposed of with your other household waste. Instead, it is your responsibility to dispose of your waste equipment by handing it over to a designated collection point for the recycling of waste electrical and electronic equipment. The separate collection and recycling of your waste equipment at the time of disposal will help conserve natural resources and ensure that it is recycled in a manner that protects human health and the environment.

For more information about where you can drop off your waste for recycling, please contact your local authority, or where you purchased your product.

DSG Retail Ltd. (co. no. 504877)
1 Portal Way, London, W3 6RS, UK

EU Representative
DSG Retail Ireland Ltd (259460)
3rd Floor Office Suite
Omni Park SC, Santry, Dublin 9, Republic of Ireland

IB-LBMFMX17-210216V4