

HYUNDAI



OWNER'S MANUAL

**Operation
Maintenance
Specifications**

All information in this Owner's Manual is current at the time of publication. However, in line with the Hyundai policy of continual product improvement, the right to amend or change specifications without prior notice or obligation to incorporate such amendments or changes into vehicles already produced, is reserved.

This manual applies to all current Hyundai models and includes descriptions and explanations of optional as well as standard equipment. As a result, you may find material in this manual that does not apply to your specific vehicle.

CAUTION: MODIFICATIONS TO YOUR HYUNDAI

Your Hyundai should not be modified in any way without the approval of Hyundai. Any modifications may adversely affect the safety, durability and performance of your Hyundai. In addition, those components which are subjected to modification or are added to the vehicle specification, and any resultant consequential damage will not be covered by the vehicle manufacturer's warranty.

TWO-WAY RADIO OR CELLULAR TELEPHONE INSTALLATION

Your vehicle is equipped with electronic fuel injection and other electronic components. It is possible for an improperly installed/adjusted two-way radio to adversely affect electronic systems. For this reason, we recommend that you carefully follow the radio manufacturer's instructions or consult your Hyundai dealer for precautionary measures or special instructions.

SAFETY AND VEHICLE DAMAGE WARNING

This manual includes information titled as WARNING, CAUTION and NOTICE.

These titles indicate the following:

WARNING

This indicates that a condition may result in harm, serious injury or death to you or other persons if the warning is not heeded. Follow the advice provided with the warning.

CAUTION

This indicates that a condition may result in damage to your vehicle or its equipment if the caution is not heeded. Follow the advice provided with the caution.

*** NOTICE**

This indicates that interesting or helpful information is being provided.

FOREWORD

Thank you for choosing Hyundai. We are pleased to welcome you to the growing number of discriminating people who drive Hyundai. The advanced engineering and high-quality construction of each Hyundai we build is something of which we're very proud.

Your Owner's Manual will introduce you to the features and operation of your new Hyundai. It is suggested that you read it carefully because the information it contains can contribute greatly to the satisfaction you receive from your new car.

The manufacturer also recommends that all service and maintenance on your car be performed by an authorised Hyundai dealer. Hyundai dealers are prepared to provide high-quality service, maintenance and any other assistance that may be required.

HYUNDAI MOTOR COMPANY

Note : If for any reason in the future you should sell your Hyundai, please leave this manual in the vehicle for the new owner's use.

CAUTION

Severe engine and transaxle damage may result from the use of poor quality fuels and lubricants that do not meet Hyundai specifications. You must always use high quality fuels and lubricants that meet the specifications listed on Page 9-4 in the Vehicle Specifications section of the Owner's Manual.

Copyright 2010 Hyundai Motor Company. All rights reserved. No part of this publication may be reproduced, stored in any retrieval system or transmitted in any form or by any means without the prior written permission of Hyundai Motor Company.

Guide to Hyundai Genuine Parts

1. What are Hyundai Genuine Parts?

Hyundai Genuine Parts are the same parts used by Hyundai Motor Company to manufacture vehicles. They are designed and tested for the optimum safety, performance, and reliability to our customers.

2. Why should you use genuine parts?

Hyundai Genuine Parts are engineered and built to meet rigid manufacturing requirements. Using imitation, counterfeit or used salvage parts is not covered under the Hyundai New Vehicle Limited Warranty or any other Hyundai warranty.

In addition, any damage to or failure of Hyundai Genuine Parts caused by the installation or failure of an imitation, counterfeit or used salvage part is not covered by any Hyundai Warranty.

3. How can you tell if you are purchasing Hyundai Genuine Parts?

Look for the Hyundai Genuine Parts Logo on the package (see below).

Hyundai Genuine Parts exported to are packaged with labels written only in English.

Hyundai Genuine Parts are only sold through authorised Hyundai Dealerships.

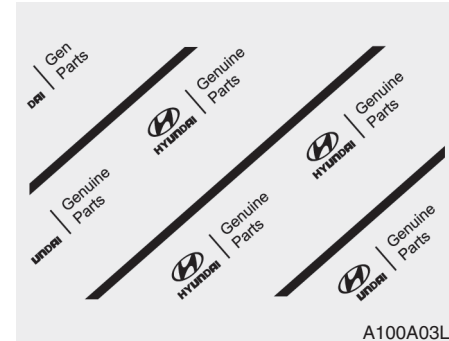

A100A03L



A100A01L



A100A02L

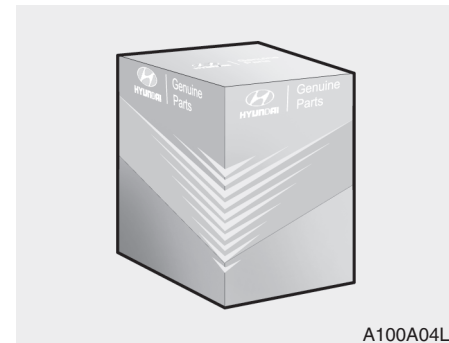

A100A04L

AUSTRALIAN DESIGN RULES

The compliance plate shows that your vehicle has been tested and found to comply with all relevant Australian Design Rules (ADR's) applicable at its date of manufacture.

Any part, that is subject to these ADR's, must not be removed or altered and is to be maintained in good order at all times for the vehicle to be roadworthy and re-registerable by all registerable authorities.

Consult an Authorised Hyundai Motors Dealer before conducting any repairs that may affect these areas or if requiring further classification on design rules or safety features. Failure to observe the above warning may render the vehicle compliance invalid and result in personal injury which may have otherwise been avoided.

TABLE OF CONTENTS

Introduction	1
Your vehicle at a glance	2
Safety system of your vehicle	3
Features of your vehicle	4
Driving your vehicle	5
What to do in an emergency	6
Maintenance	7
Consumer information	8
Specifications	9
Index	I

Introduction

1

How to use this manual / 1-2

Fuel requirements / 1-2

Vehicle run-in process / 1-5

Indicator symbols on the instrument cluster / 1-6

HOW TO USE THIS MANUAL

A010000AUN-EA

We want to help you get the greatest possible driving pleasure from your vehicle. Your Owner's Manual can assist you in many ways. We strongly recommend that you read the entire manual. In order to minimise the chance of death or injury, you must read the WARNING and CAUTION sections in the manual.

Illustrations complement the words in this manual to best explain how to enjoy your vehicle. By reading your manual, you will learn about features, important safety information, and driving tips under various road conditions.

The general layout of the manual is provided in the Table of Contents. A good place to start is the index; it has an alphabetical listing of all information in your manual.

Sections: This manual has nine sections plus an index. Each section begins with a brief list of contents so you can tell at a glance if that section has the information you want.

You'll find various WARNINGS, CAUTIONS, and NOTICES in this manual. These were prepared to enhance your personal safety. You should carefully read and follow ALL procedures and recommendations provided in these WARNINGS, CAUTIONS and NOTICES.

WARNING

A WARNING indicates a situation in which harm, serious bodily injury or death could result if the warning is ignored.

CAUTION

A CAUTION indicates a situation in which damage to your vehicle could result if the caution is ignored.

* NOTICE

A NOTICE indicates interesting or helpful information is being provided.

FUEL REQUIREMENTS

Petrol engine

A020101AFD-EA

Unleaded

Your new vehicle is designed to use only unleaded fuel having an Octane Rating of RON (Research Octane Number) 91 / AKI (Anti-Knock Index) 87 or higher.

Your new vehicle is designed to obtain maximum performance with UNLEADED FUEL, as well as minimise exhaust emissions and spark plug fouling.

CAUTION

NEVER USE LEADED FUEL. The use of leaded fuel is detrimental to the catalytic converter and will damage the engine control system's oxygen sensor and affect emission control.

Never add any fuel system cleaning agents to the fuel tank other than what has been specified. (Consult an authorised HYUNDAI dealer for details.)

⚠ WARNING

- Do not "top off" after the nozzle automatically shuts off when refuelling.
- Always check that the fuel cap is installed securely to prevent fuel spillage in the event of an accident.

A020103AUN-EA

Petrol containing alcohol and methanol

Ethanol [E-10], a mixture of petrol and ethanol (also known as grain alcohol), and petrol or ethanol containing methanol (also known as wood alcohol) are being marketed along with or instead of leaded or unleaded petrol.

Do not use ethanol containing more than 10% ethanol, and do not use petrol or ethanol containing any methanol. Either of these fuels may cause drivability problems and damage to the fuel system.

Discontinue using ethanol of any kind if drivability problems occur.

Vehicle damage or driveability problems may not be covered by the manufacturer's warranty if they result from the use of:

1. Ethanol containing more than 10%.
2. Petrol or ethanol containing methanol.
3. Leaded fuel or leaded ethanol.

⚠ CAUTION

Never use ethanol which contains methanol. Discontinue use of any ethanol product which impairs drivability.

A020104AUN-EA

Use of MTBE

We recommend that fuels containing MTBE (Methyl Tertiary Butyl Ether) over 15.0% vol. (Oxygen Content 2.7% weight) should not be used in your vehicle.

Fuel containing MTBE over 15.0% vol. (Oxygen Content 2.7% weight) may reduce vehicle performance and produce vapour lock or hard starting.

⚠ CAUTION

Your New Vehicle Limited Warranty may not cover damage to the fuel system and any performance problems that are caused by the use of fuels containing methanol or fuels containing MTBE (Methyl Tertiary Butyl Ether) over 15.0% vol. (Oxygen Content 2.7% weight.)

A020105AUN-EA

Do not use methanol

Fuels containing methanol (wood alcohol) should not be used in your vehicle. This type of fuel can reduce vehicle performance and damage components of the fuel system.

CAUTION

Hyundai Warranty Policy will not cover damage to the fuel system and performance problems that are caused by the use of methanol or fuels containing methanol.

A020106AUN-EA

Petrols for cleaner air

To help contribute to cleaner air, we recommend that you use petrols treated with detergent additives, which help prevent deposit formation in the engine. These petrols will help the engine run cleaner and enhance performance of the Emission Control System.

A020107AUN

Operation in foreign countries

If you are going to drive your vehicle in another country, be sure to:

- Observe all regulations regarding registration and insurance.
- Determine that acceptable fuel is available.

Diesel engine

A020201AUN-EA

Diesel fuel

Diesel engine must be operated only on commercially available diesel fuel that complies with EN 590 or comparable standard. (EN stands for "European Norm"). Do not use marine diesel fuel, heating oils, or non-approved fuel additives, as this will increase wear and cause damage to the engine and fuel system. The use of non-approved fuels and/or fuel additives will result in a limitation of your warranty rights.

Diesel fuel of above cetane 51 is used in your vehicle. If two types of diesel fuel are available, use summer or winter fuel properly according to the following temperature conditions.

- Above -5°C (23°F) ... Summer type diesel fuel.
- Below -5°C (23°F) ... Winter type diesel fuel.

Watch the fuel level in the tank very carefully : If the engine stops through fuel failure, the circuits must be completely purged to permit restarting.

CAUTION

- ***Do not let any petrol or water enter the tank. This would make it necessary to drain it out and to bleed the lines to avoid jamming the injection pump and damaging the engine.***
- ***In winter, in order to cut down incidents due to freezing, paraffin oil may be added to the fuel if the temperature drops to below -10°C (14°F). Never use more than 20% paraffin oil.***

**⚠ CAUTION - Diesel Fuel
(if equipped with DPF)**

It is recommended to use the regulated automotive diesel fuel for diesel vehicle equipped with the DPF system.

If you use diesel fuel including high sulfur (more than 50 ppm sulfur) and unspecified additives, it can cause the DPF system to be damaged and white smoke can be emitted.

A020202AUN

Biodiesel

Commercially supplied Diesel blends of no more than 7% biodiesel, commonly known as "B7 Diesel" may be used in your vehicle if Biodiesel meets EN 14214 or equivalent specifications. (EN stands for "European Norm"). The use of biofuels exceeding 7% made from rapeseed methyl ester (RME), fatty acid methyl ester (FAME), vegetable oil methyl ester (VME) etc. or mixing diesel exceeding 7% with biodiesel will cause increased wear or damage to the engine and fuel system. Repair or replacement of worn or damaged components due to the use of non approved fuels will not be covered by the manufactures warranty.

Biodiesel (for New Zealand)

Commercially supplied Diesel blends of no more than 7% biodiesel, commonly known as "B7 Diesel" may be used in your vehicle if Biodiesel meets EN 14214 or equivalent specifications. (EN stands for "European Norm"). The use of biofuels exceeding 7%, made from rapeseed methyl ester (RME), vegetable oil methyl ester (VME) etc. or mixing diesel exceeding 7% with biodiesel will cause increased wear or damage to the engine and fuel system. Repair or replacement of worn or damaged components due to the use of non approved fuels will not be covered by the manufactures warranty.

⚠ CAUTION

- ***Never use any fuel, whether diesel, B7 biodiesel or otherwise, that fails to meet the latest petroleum industry specification.***
- ***Never use any fuel additives or treatments that are not recommended or approved by the vehicle manufacturer.***

VEHICLE RUN-IN PROCESS























A030000AUN-EA

No special run-in period is needed. By following a few simple precautions for the first 1,000 km (600 miles) you may add to the performance, economy and life of your vehicle.

- Do not race the engine.
- While driving, keep your engine speed (rpm, or revolutions per minute) between 2,000 rpm and 4,000 rpm.
- Do not maintain a single speed for long periods of time, either fast or slow. Varying engine speed is needed to properly run-in the engine.
- Avoid hard stops, except in emergencies, to allow the brakes to seat properly.
- Don't let the engine idle longer than 3 minutes at one time.
- Don't tow a trailer during the first 2,000 km (1,200 miles) of operation.

INDICATOR SYMBOLS ON THE INSTRUMENT CLUSTER

A050000AFD-EA

	Door and tailgate ajar warning light		Charging system warning light
	Seat belt warning light		Malfunction indicator (if equipped)
	High beam indicator		Air bag warning light (if equipped)
	Turn signal indicator		Cruise indicator (if equipped)
	Front fog light indicator (if equipped)		Cruise SET indicator (if equipped)
	Rear fog light indicator (if equipped)		Immobiliser indicator (if equipped)
	ESP indicator (if equipped)		Low windshield washer fluid level warning light (if equipped)
	ESP OFF indicator (if equipped)		Low fuel level warning light
	ABS warning light (if equipped)		Glow indicator (Diesel only)
	Hand brake & Brake fluid warning light		Fuel filter warning light (Diesel only)
	Engine oil pressure warning light		Electric power steering (EPS) system warning light

* For more detailed explanations, refer to section 4, "Instrument cluster".

Your vehicle at a glance

2

Interior overview / 2-2

Instrument panel overview / 2-3

INTERIOR OVERVIEW

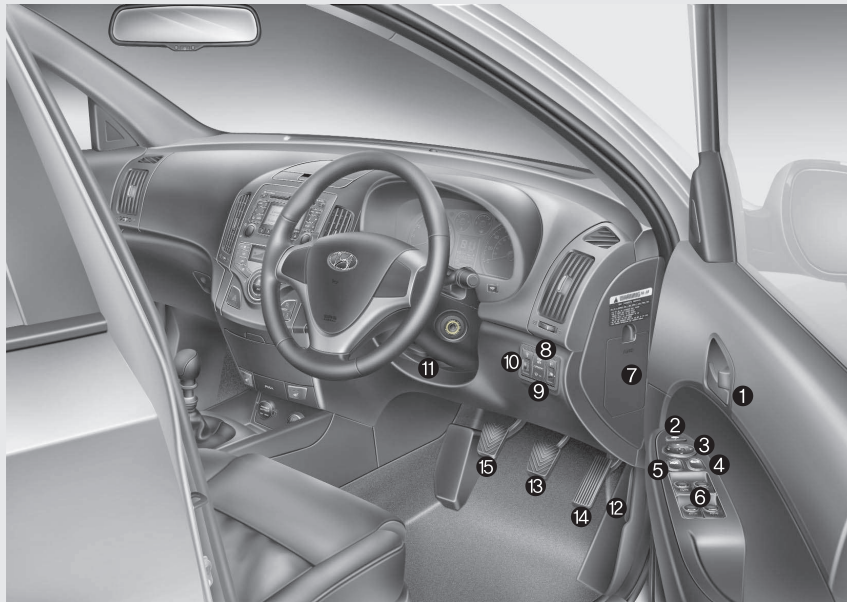

- 1. Door lock/unlock button4-8
- 2. Outside rearview mirror folding button* ..4-33
- 3. Outside rearview mirror control switch*4-32
- 4. Central door lock switch*4-9
- 5. Power window lock switch*4-17
- 6. Power window switches*4-15
- 7. Fuse box7-57
- 8. ESP OFF button*5-22
- 9. Front windshield deicer button*4-63
- 10. Instrument panel illumination.....4-35
- 11. Steering wheel tilt4-29
- 12. Bonnet release lever.....4-19
- 13. Brake pedal5-17
- 14. Accelerator pedal.....5-5
- 15. Clutch pedal*5-9

* : if equipped

OFD027001EA

B010001AFD-EA

INSTRUMENT PANEL OVERVIEW

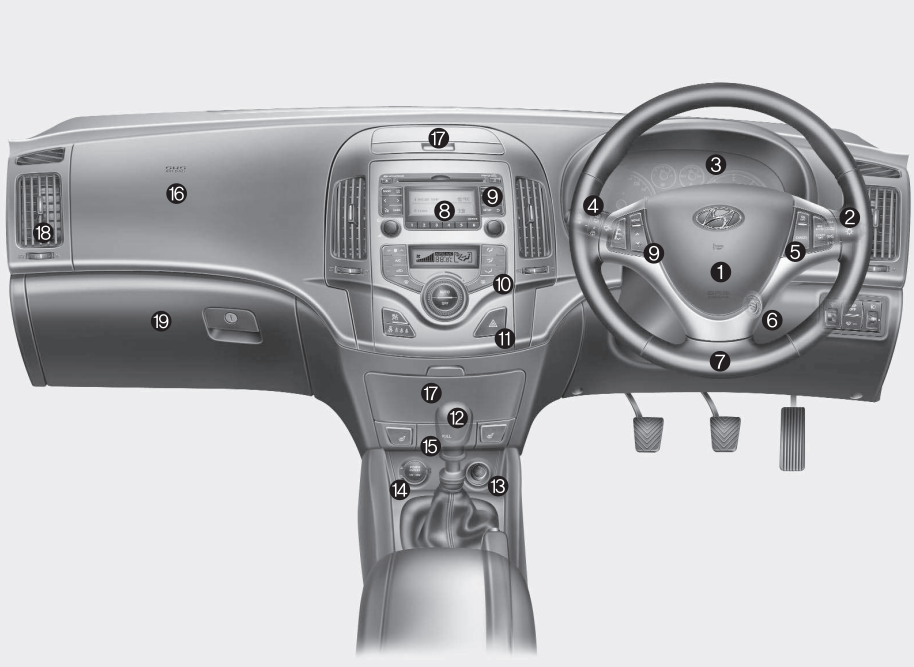

- 1. Driver's air bag*3-37
 - 2. Light control / Turn signals4-51
 - 3. Instrument cluster4-34
 - 4. Wiper/Washer4-56
 - 5. Auto cruise controls*5-27
 - 6. Ignition switch5-4
 - 7. Steering wheel4-28
 - 8. Digital clock*4-92
 - 9. Audio controls*4-102, 4-106
 - 10. Climate control system*4-64
 - 11. Hazard warning flasher switch4-52
 - 12. Shift lever5-8
 - 13. Cigarette lighter4-89
 - 14. Power outlet4-91
 - 15. Ashtray4-89
 - 16. Passenger's air bag*3-37
 - 17. Multi box*4-87
 - 18. Vent controls4-67
 - 19. Glove box4-85
- * : if equipped

B020001AFD-EA

OFD027002EA

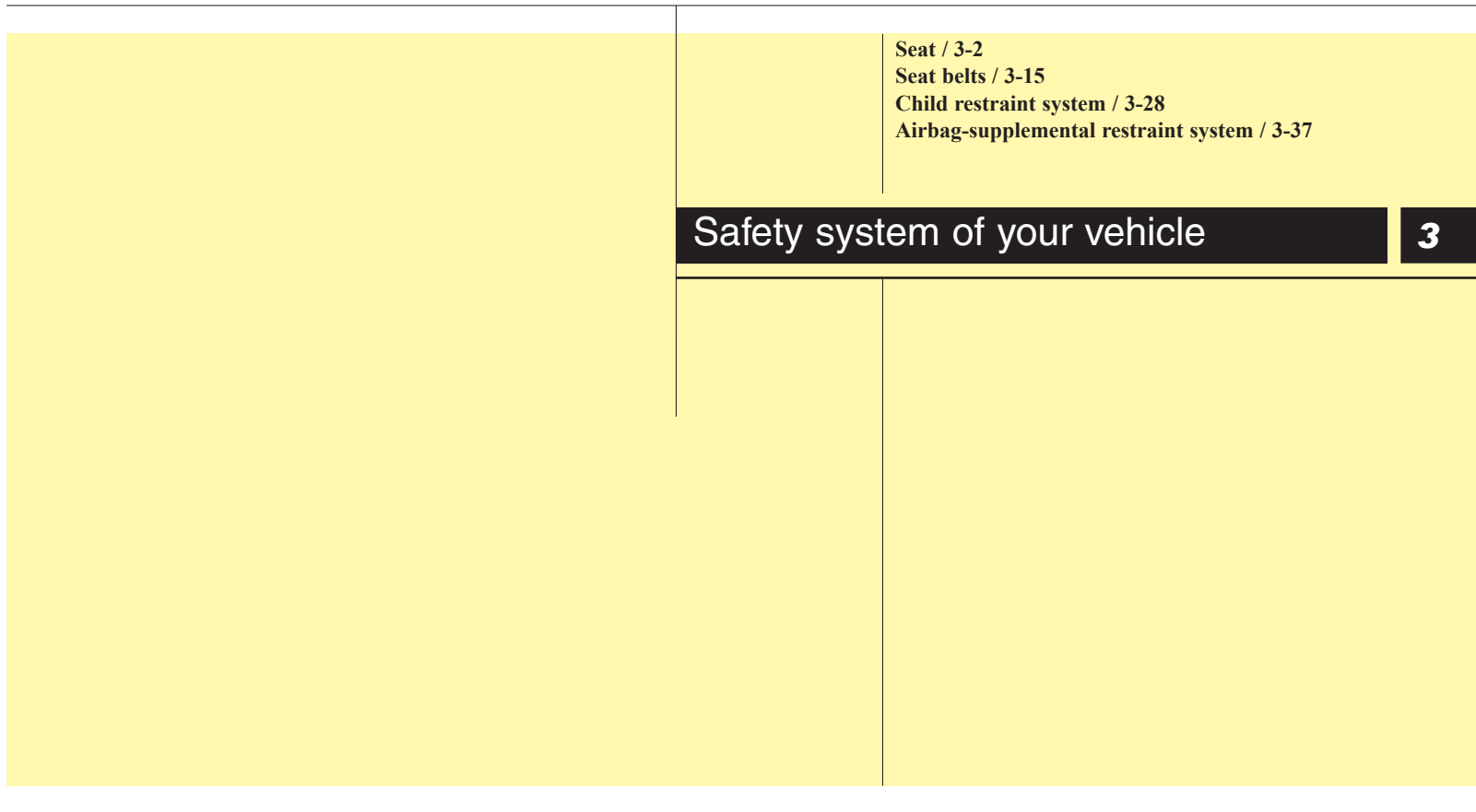
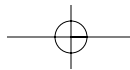

Seat / 3-2
Seat belts / 3-15
Child restraint system / 3-28
Airbag-supplemental restraint system / 3-37

Safety system of your vehicle

3

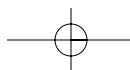
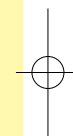

Safety system of your vehicle

SEAT

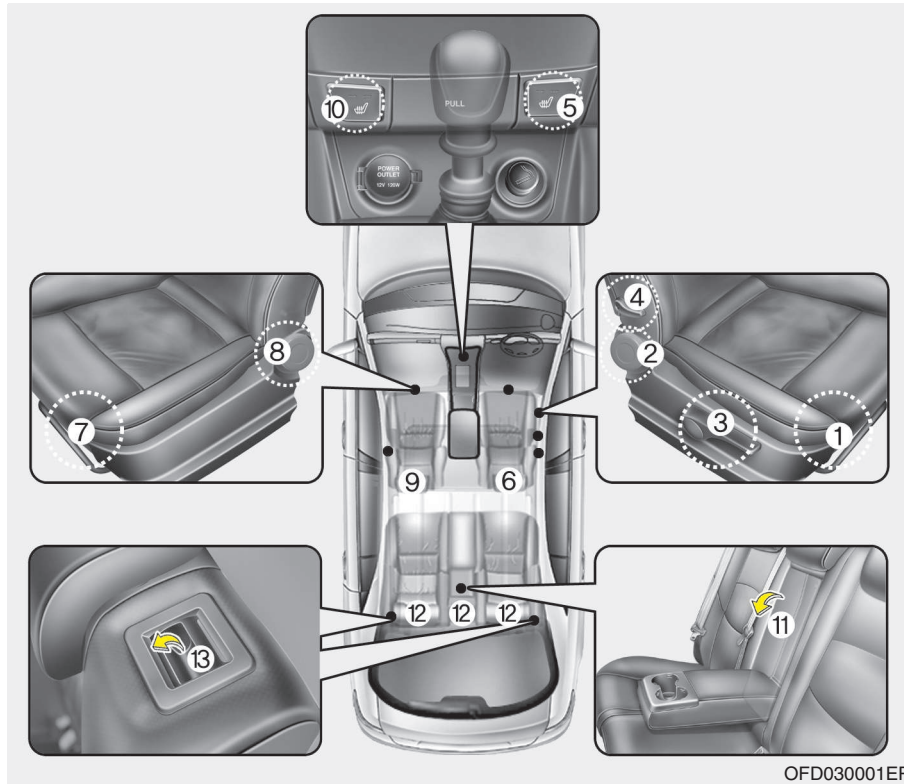

Front seat

- (1) Fore/aft seat slide adjustment lever (driver seat)
- (2) Seatback recline knob (driver seat)
- (3) Seat cushion height adjuster (driver seat)*
- (4) Lumbar support adjuster (driver seat)*
- (5) Seat warmer (driver seat)*
- (6) Head restraint (driver seat)
- (7) Fore/aft seat slide adjustment lever (passenger seat)
- (8) Seatback recline knob (passenger seat)
- (9) Head restraint (passenger seat)
- (10) Seat warmer (passenger seat)*

Rear seats

- (11) Centre armrest*
- (12) Head restraint (outboard and/or centre*)
- (13) Folding seatback release lever

* : if equipped

* The actual feature in the vehicle may differ from the illustration.

C010000AFD-UK

⚠ WARNING - Loose objects
Loose objects in the driver's foot area could interfere with the operation of the foot pedals, possibly causing an accident. Do not place anything under the front seats.

⚠ WARNING - Uprighting seat
When you return the seatback to its upright position, hold the seatback and return it slowly and be sure there are no other occupants around the seat. If the seatback is returned without being held and controlled, the back of the seat could spring forward resulting in accidental injury to a person struck by the seatback.

⚠ WARNING - Driver responsibility for front seat passenger
Riding in a vehicle with a front seatback reclined could lead to serious or fatal injury in an accident. If a front seat is reclined during an accident, the occupant's hips may slide under the lap portion of the seat belt applying great force to the unprotected abdomen. Serious or fatal internal injuries could result. The driver must advise the front passenger to keep the seatback in an upright position whenever the vehicle is in motion.

⚠ WARNING - Driver's seat

- Never attempt to adjust seat whilst the vehicle is moving. This could result in loss of control, and an accident causing death, serious injury, or property damage.
- Do not allow anything to interfere with the normal position of the seatback. Storing items against a seatback or in any other way interfering with proper locking of a seatback could result in serious or fatal injury in a sudden stop or collision.
- Always drive and ride with your seatback upright and the lap portion of the seat belt snug and low across the hips. This is the best position to protect you in case of an accident.
- In order to avoid unnecessary and perhaps severe air bag injuries, always sit as far back as possible from the steering wheel whilst maintaining comfortable control of the vehicle. It is recommended that your chest is at least 10 inches (250 mm) away from the steering wheel.

Safety system of your vehicle

⚠ WARNING

After adjusting the seat, always check that it is securely locked into place by attempting to move the seat forward or backwards without using the fore/aft adjuster.

Sudden or unexpected movement of the driver's seat could cause you to lose control of the vehicle resulting in an accident.



Front seat adjustment

C010101AUN

Forward and backward

To move the seat forward or backward:

1. Pull the seat slide adjustment lever under the front edge of the seat cushion up and hold it.
2. Slide the seat to the position you desire.
3. Release the lever and make sure the seat is locked in place.

Adjust the seat before driving, and make sure the seat is locked securely by trying to move forward and backward without using the lever. If the seat moves, it is not locked properly.

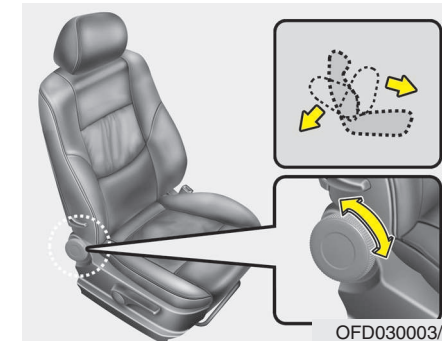

C010102AUN

Seatback angle

To adjust the seatback position, rotate the seatback recline knob located on the outside of the seat at the rear.

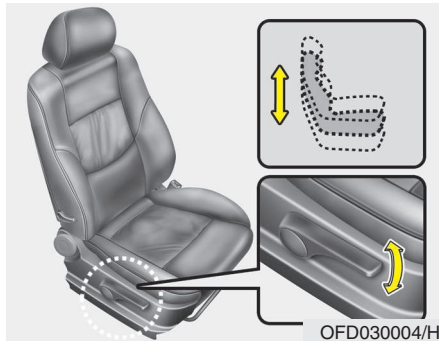

C010104AFD-UK

Head restraint

The driver's and front passenger's seats are equipped with a head restraint for the occupant's safety and comfort.

The head restraint not only provides comfort for the driver and front passenger, but also helps to protect the head and neck in the event of a collision.

C010103AUN

Seat cushion height (for driver's seat) (if equipped)

To change the height of the seat cushion, push the lever that is located on the outside of the seat cushion upwards or downwards.

- To lower the seat cushion, push down the lever several times.
- To raise the seat cushion, pull up the lever several times.

⚠ WARNING

- For maximum effectiveness in case of an accident, the head restraint should be adjusted so the middle of the head restraint is at the same height of the centre of gravity of an occupant's head. Generally, the centre of gravity of most people's head is similar with the height of the top of their eyes. Also, adjust the head restraint as close to your head as possible. For this reason, the use of a cushion that holds the body away from the seatback is not recommended.
- Do not operate the vehicle with the head restraints removed as severe injury to the occupants may occur in the event of an accident. Head restraints may provide protection against neck injuries when properly adjusted.
- Do not adjust the head restraint position of the driver's seat whilst the vehicle is in motion.

Safety system of your vehicle

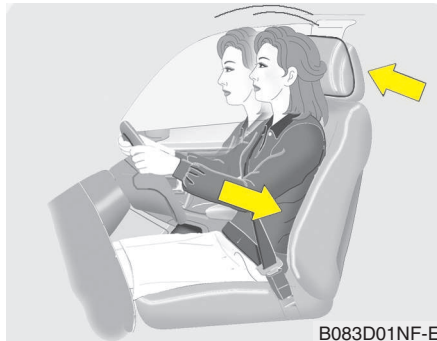

Active head restraint (if equipped)

The active head restraint is designed to move forward and upward in the event of a rear impact. This helps to prevent the driver and front passenger head from moving backward and thus helps prevent neck injuries.

When adjusting the head restraint position, the head restraint guides located in the seat may move upwards - this is indicative of normal operation of the active head restraint system.

⚠ WARNING

A gap between the seat and the headrest release button may appear when seating on the seat or when you push or pull the seat. Be careful not to get your finger, etc. caught in the gap.

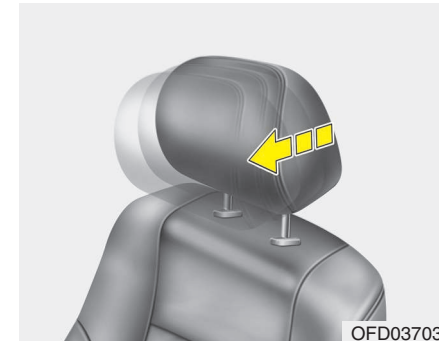

Forward and backward adjustment (if equipped)

The head restraint may be adjusted forward to 3 different positions by pulling the head restraint forward to the desired detent. To adjust the head restraint to its furthest backwards position, pull it fully forward to the farthest position and release it. Adjust the head restraint so that it properly supports the head and neck.

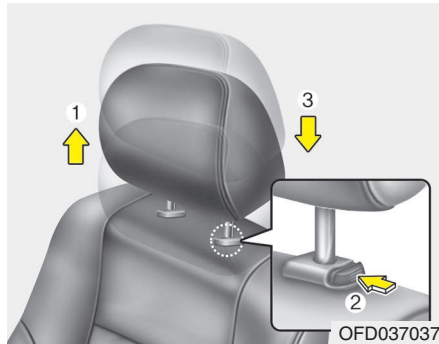

Adjusting the height up and down

To raise the head restraint, pull it up to the desired position (1). To lower the head restraint, push and hold the release button (2) on the head restraint support and lower the head restraint to the desired position (3).

OFD037037

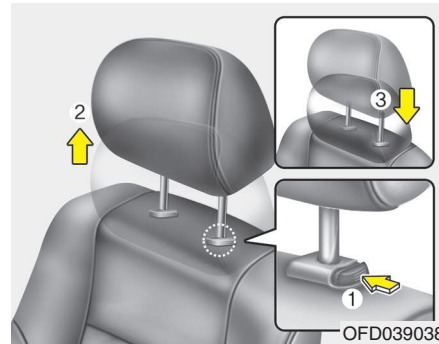

Removal

To remove the head restraint, raise it as far as it can go then press the release button (1) whilst pulling upward (2).

To reinstall the head restraint, put the head restraint poles (3) into the holes whilst pressing the release button (1). Then adjust it to the appropriate height.

OFD039038

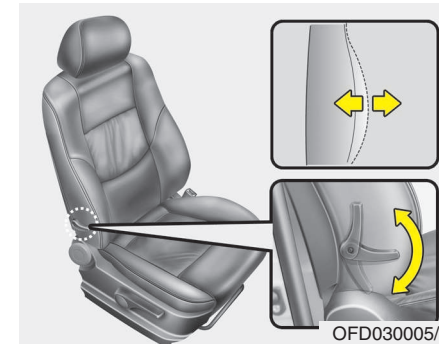

C010105AFD

**Lumbar support
(for driver's seat, if equipped)**

The lumbar support can be adjusted by moving the lever on the outside of the driver's seatback. Pivoting the lever increases or decreases lumbar support.

OFD030005/H

⚠ WARNING

Make sure the head restraint locks in position after adjusting it to properly protect the occupants.

Safety system of your vehicle

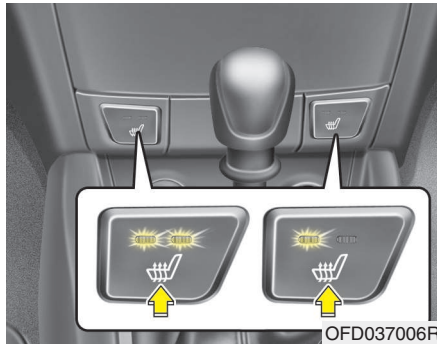

C010107AFD-UK

Seat warmer (if equipped)

The seat warmer is provided to warm the front seats during cold weather. With the ignition switch in the ON position, push either of the switches to warm the driver's seat or the front passenger's seat.

During mild weather or under conditions where the operation of the seat warmer is not needed, keep the switches in the "OFF" position.

- Each time you push the button, the temperature setting of the seat is changed as follows :

OFF → HIGH (☀️) → LOW (☀️)

- The seat warmer defaults to the OFF position whenever the ignition switch is turned on.

* NOTICE

With the seat warmer switch in ON position, the heating system in the seat turns off or on automatically depending on the seat temperature.

⚠️ CAUTION

- *When cleaning the seats, do not use an organic solvent such as thinner, benzene, alcohol and petrol. Doing so may damage the surface of the heater or seats.*
- *To prevent overheating the seat warmer, do not place blankets, cushions or seat covers on the seats whilst the seat warmer is in operation.*
- *Do not place heavy or sharp objects on seats equipped with seat warmers. Damage to the seat warming components could occur.*

⚠️ WARNING - Seat warmer burns

Passengers should use extreme caution when using seat warmers due to the possibility of excess heating or burns. In particular, the driver must exercise extreme care for the following types of passengers:

1. Infants, children, elderly or handicapped persons, or hospital out-patients
2. Persons with sensitive skin or those that burn easily
3. Fatigued individuals
4. Intoxicated individuals
5. Individuals taking medication that can cause drowsiness or sleepiness (sleeping pills, cold tablets, etc.)



Rear seat adjustment

C010303AFD-UK

Head restraint

The rear seat(s) is equipped with head restraints in all the seating positions for the occupant's safety and comfort. The head restraint not only provides comfort for passengers, but also helps to protect the head and neck in the event of a collision.

C010108AUN

Seatback pocket (if equipped)

The seatback pocket is provided on the back of the front passenger's and driver's seatbacks.

⚠ WARNING - Seatback pockets

Do not put heavy or sharp objects in the seatback pockets. In an accident they could come loose from the pocket and injure vehicle occupants.

⚠ WARNING

- For maximum effectiveness in case of an accident, the head restraint should be adjusted so the middle of the head restraint is at the same height of the centre of gravity of an occupant's head. Generally, the centre of gravity of most people's head is similar with the height of the top of their eyes. Also adjust the head restraint as close to your head as possible. The use of a cushion that holds the body away from the seatback is not recommended.
- Do not operate the vehicle with the head restraints removed as severe injury to an occupant may occur in the event of an accident. Head restraints may provide protection against severe neck injuries when properly adjusted.

Safety system of your vehicle

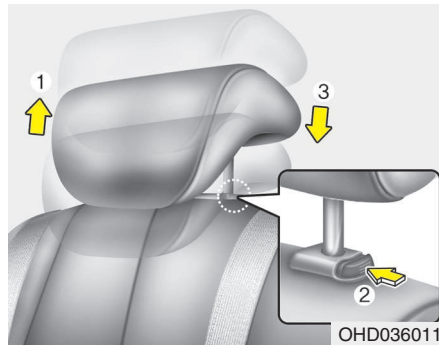

Adjusting the height up and down

To raise the head restraint, pull it up to the desired position (1). To lower the head restraint, push and hold the release button (2) on the head restraint support and lower the head restraint to the desired position (3).

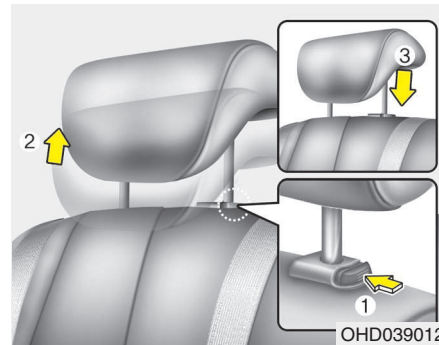

Removal

To remove the head restraint, raise it as far as it can go then press the release button (1) whilst pulling upward (2).

To reinstall the head restraint, put the head restraint poles (3) into the holes whilst pressing the release button (1). Then adjust it to the appropriate height.

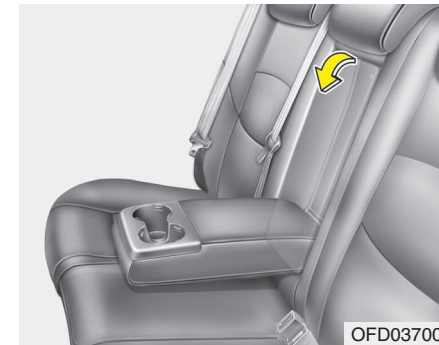

C010304AFD-UK

Armrest (if equipped)

To use the armrest, pull it forward from the seatback.

⚠ WARNING

Make sure the head restraint locks in position after adjusting it to properly protect the occupants.

⚠ CAUTION

- **Make sure the engine is off, the transaxle is in P and the parking brake is applied whenever loading or unloading cargo. Vehicle may move if shift lever is inadvertently moved to another position.**
- **Be careful when loading cargo through the rear passenger seats to prevent damage to the vehicle interior.**
- **When cargo is loaded through the rear passenger seats, ensure the cargo is properly secured to prevent it from moving whilst driving. Unsecured cargo in the passenger compartment can cause damage to the vehicle or injury to it's occupants.**

C010307BFD-UK

Folding the rear seat

The rear seatbacks (or cushions) may be folded to facilitate carrying long items or to increase the luggage capacity of the vehicle.

⚠ WARNING

The purpose of the fold-down rear seatbacks (or cushions) is to allow you to carry longer objects than could otherwise be accommodated. Never allow passengers to sit on top of the folded down seatback whilst the car is moving as this is not a proper seating position and no seat belts are available for use. This could result in serious injury or death in case of an accident or sudden stop. Objects carried on the folded down seatback should not extend higher than the top of the front seats. This could allow cargo to slide forward and cause injury or damage during sudden stops.

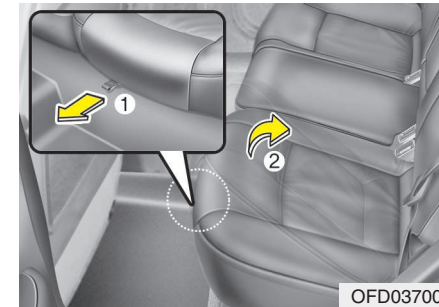

To fold the rear seat cushion and back
- 5 Door

1. Set the front seatback to the upright position and if necessary, slide the front seat forward.
2. Pull the cushion folding strap (1) and lift the front portion of the seat cushion.

Safety system of your vehicle

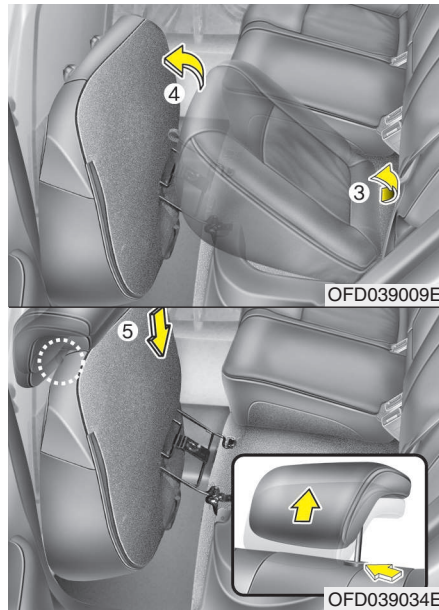

3. Lift the rear portion of the seat cushion. Stand the rear seat cushion vertically.
4. Remove the head restraint from the rear seatback.
5. Stow the head restraint by inserting the head restraint poles into the holder on the bottom of the seat cushion.

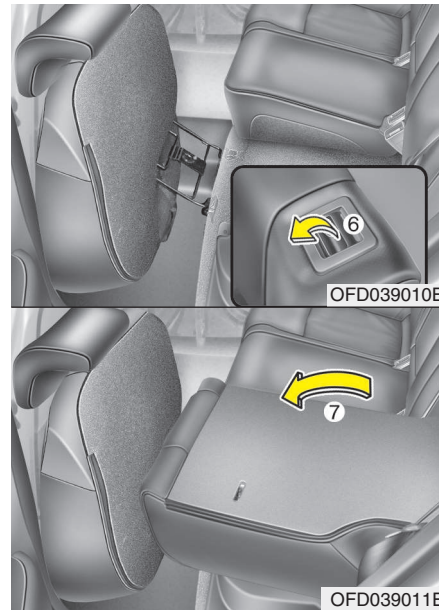

6. Pull the lock release lever (red visible) and fold the rear seatback forward and down firmly.
7. To use the rear seat, lift and push the seatback backward firmly until it clicks into place. Make sure the seatback is locked in place (red invisible).

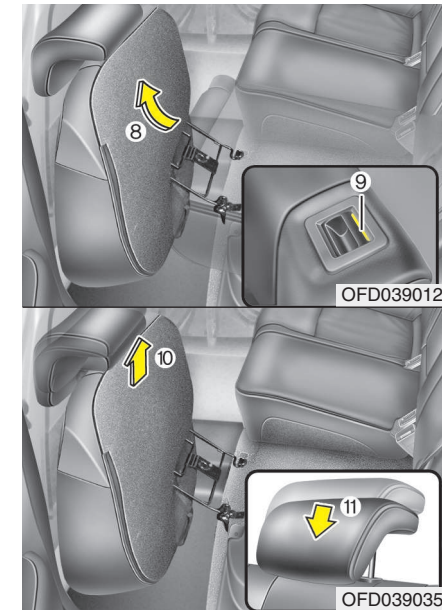

8. Reposition the head restraint on the seatback and adjust it to the desired position.
9. To use the rear seat, lift and push the seatback backward firmly until it clicks into place. Make sure the seatback is locked in place (red invisible).
10. Reposition the head restraint on the seatback and adjust it to the desired position.
11. To use the rear seat, lift and push the seatback backward firmly until it clicks into place. Make sure the seatback is locked in place (red invisible).

Safety system of your vehicle

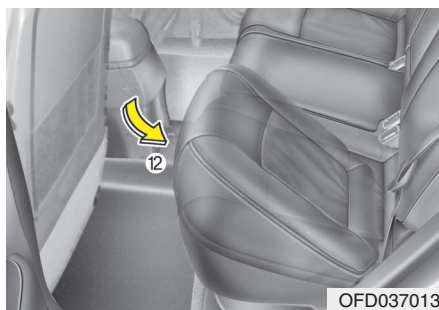

9. Return the seat cushion to the original position by pushing down the rear side of the seat cushion first. Make sure the seat cushion is locked in place.
10. Return the rear seat belt to the proper position.

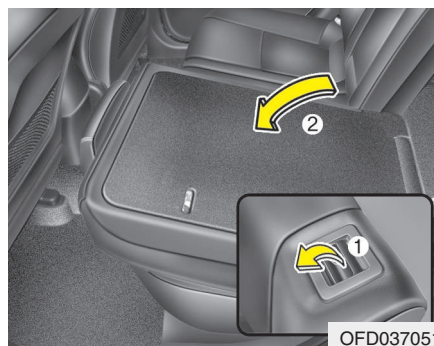

- Wagon
1. Pull the lock release lever (red visible) and fold the rear seatback forward and down firmly.

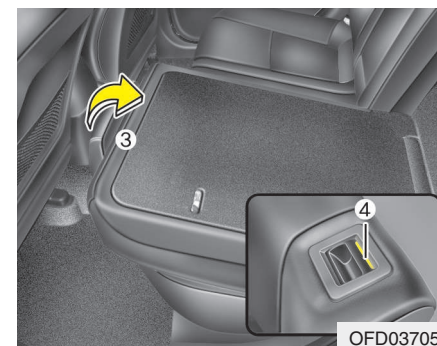

2. To use the rear seat, lift and push the seatback backward firmly until it clicks into place. Make sure the seatback is locked in place (red invisible).
3. Return the rear seat belt to the proper position.

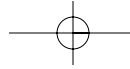

Safety system of your vehicle

WARNING

When you return the rear seatback to its upright position after being folded down:

Be careful not to damage the seat belt webbing or buckle. Do not allow the seat belt webbing or buckle to get caught or pinched in the rear seat. Ensure that the seatback is completely locked into its upright position by pushing on the top of the seatback. Otherwise, in an accident or sudden stop, the seat could fold down and allow cargo to enter the passenger compartment, which could result in serious injury or death.

CAUTION - Rear seat belts

When returning the rear seatbacks to the upright position, remember to return the rear shoulder belts to their proper position.

WARNING - Cargo

Cargo should always be secured to prevent it from being thrown about the vehicle in a collision and causing injury to the vehicle occupants. Special care should be taken of objects placed in the rear seats, since those may hit the front seat occupants in a frontal collision.

WARNING - Cargo loading

Make sure the engine is off, the transaxle is in P and the parking brake is applied whenever loading or unloading cargo. Failure to take these steps may allow the vehicle to move if shift lever is inadvertently moved to another position.

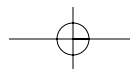
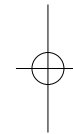
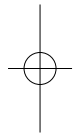

SEAT BELTS

C020100AUN

Seat belt restraint system

WARNING

- For maximum restraint system protection, the seat belts must always be used whenever the car is moving.
- Seat belts are most effective when seatbacks are in the upright position.
- Children age 12 and younger must always be properly restrained in the rear seat. Never allow children to ride in the front passenger seat. If a child over 12 must be seated in the front seat, he/she must be properly belted and the seat should be moved as far back as possible.
- Never wear the shoulder belt under your arm or behind your back. An improperly positioned shoulder belt can cause serious injuries in a crash. The shoulder belt should be positioned midway over your shoulder across your collarbone.

(Continued)

(Continued)

- Avoid wearing twisted seat belts. A twisted belt can't do its job as well. In a collision, it could even cut into you. Be sure the belt webbing is straight and not twisted.
- Be careful not to damage the belt webbing or hardware. If the belt webbing or hardware is damaged, replace it.

WARNING

Seat belts are designed to bear upon the bony structure of the body, and should be worn low across the front of the pelvis or the pelvis, chest and shoulders, as applicable; wearing the lap section of the belt across the abdominal area must be avoided.

Seat belts should be adjusted as firmly as possible, consistent with comfort, to provide the protection for which they have been designed. A slack belt will greatly reduce the protection afforded to the wearer.

(Continued)

(Continued)

Care should be taken to avoid contamination of the webbing with polishes, oils and chemicals, and particularly battery acid. Cleaning may safely be carried out using mild soap and water. The belt should be replaced if webbing becomes frayed, contaminated or damaged. It is essential to replace the entire assembly after it has been worn in a severe impact even if damage to the assembly is not obvious. Belts should not be worn with straps twisted. Each seat belt assembly must only be used by one occupant; it is dangerous to put a belt around a child being carried on the occupant's lap.

WARNING

No modifications or additions should be made by the user which will either prevent the seat belt adjusting devices from operating to remove slack, or prevent the seat belt assembly from being adjusted to remove slack.

Safety system of your vehicle



C020101AFD-UK

Seat belt warning

Type A

As a reminder to the driver, the seat belt warning light will blink for approximately 6 seconds each time you turn the ignition switch ON regardless of belt fastening.

If the driver's seat belt is unfastened after the ignition switch is ON, the seat belt warning light blinks again for approximately 6 seconds.

If the driver's seat belt is not fastened when the ignition switch is turned ON or if it is unfastened after the ignition switch is ON, the seat belt warning chime will sound for approximately 6 seconds. At this time, if the seat belt is fastened, the chime will stop at once. (if equipped)

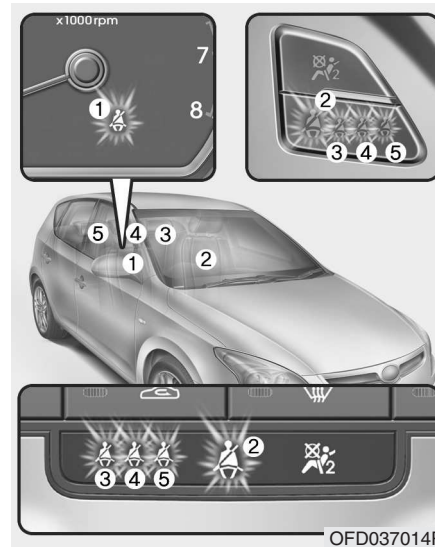

Type B

As a reminder to the driver and front passenger, the driver's and front passenger's seat belt warning lights will illuminate for approximately 6 seconds each time you turn the ignition switch ON regardless of belt fastening.

If the driver's or front passenger's seat belt is not fastened when the ignition switch is turned ON or if it is disconnected after the ignition switch is turned ON, the corresponding seat belt warning light will illuminate or blink until the belt is fastened.

If the driver's or front passenger's seat belt is not fastened when the ignition switch is turned ON and you drive over 12 mph (20 km/h), the seat belt warning chime will sound for approximately 100 seconds.

If the driver's or front passenger's seat belt is disconnected after the ignition switch is turned ON and you drive over 12 mph (20 km/h), the seat belt warning chime will sound for approximately 100 seconds.

After 100 seconds, if the seat belt is connected and disconnected again, the seat belt warning chime will sound again.

* NOTICE

- You can find the front passenger's seat belt warning light on the centre fascia panel.
- Although the front passenger seat is not occupied, the seat belt warning light will blink or illuminate for 6 seconds.
- The front passenger's seat belt warning may operate when luggage is placed on the front passenger seat.

Safety system of your vehicle

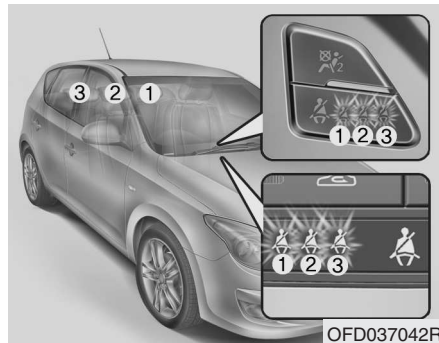

Rear passenger's seat belt warning (if equipped)

The rear passenger seat belt warning lights will illuminate when the ignition is turned ON regardless of which, if any, rear seats are occupied. As each belt is fastened, the indicator colour changes from red (unfastened) to green (fastened). The lights will extinguish within 35 seconds of the vehicle speed reaching 6mph (9km/h).

The lights will illuminate when the vehicle stops, to remind the driver of the status of each rear seat belt and will extinguish within 35 seconds of the vehicle speed reaching 6mph (9km/h).

If a seat belt is unfastened whilst the car is in motion, the seat belt warning lights will be illuminated and will display the status of each belt (red - unfastened, green - fastened). The location of the belt unfastened after the vehicle has been set in motion will be indicated by a red flashing indicator and a warning chime will sound.

If a rear seat belt is fastened and unfastened twice within 9 seconds, the rear seat belt indicator system will be turned off and will not function again until the ignition switch has been turned OFF.

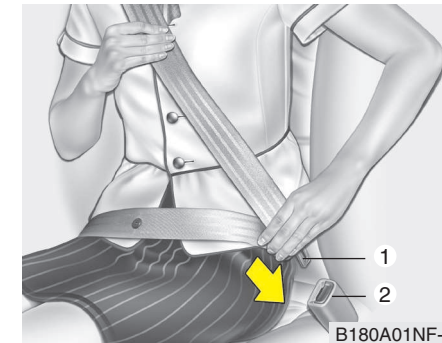

C020102AFD-UK

Lap/shoulder belt

To fasten your seat belt:

To fasten your seat belt, pull it out of the retractor and insert the metal tab (1) into the buckle (2). There will be an audible "click" when the tab locks into the buckle.

The seat belt automatically adjusts to the proper length only after the lap belt portion is adjusted manually so that it fits snugly around your hips. If you lean forward in a slow, easy motion, the belt will extend and let you move around. If there is a sudden stop or impact, however, the belt will lock into position. It will also lock if you try to lean forward too quickly.

Safety system of your vehicle

* NOTICE

If you are not able to pull out the seat belt from the retractor, firmly pull the belt out and release it. Then you will be able to pull the belt out smoothly.

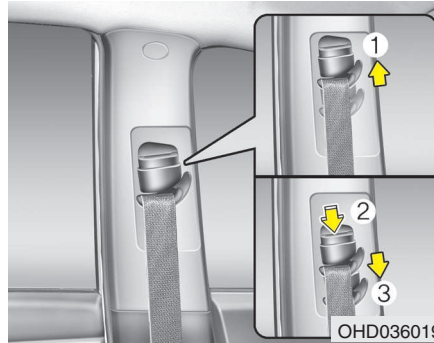

You can adjust the height of the shoulder belt anchor to one of 4 positions for maximum comfort and safety.

If the height of the adjusting seat belt is too near your neck, you will not be getting the most effective protection. The shoulder portion should be adjusted so that it lies across your chest and midway over your shoulder nearest the door and not your neck.

To adjust the height of the seat belt anchor, lower or raise the height adjuster into an appropriate position.

To raise the height adjuster, pull it up (1). To lower it, push it down (3) whilst pressing the height adjuster button (2).

Release the button to lock the anchor into position. Try sliding the height adjuster to make sure that it has locked into position.

⚠ WARNING

- **Verify the shoulder belt anchor is locked into position at the appropriate height. Never position the shoulder belt across your neck or face. Improperly positioned seat belts can cause serious injuries in an accident.**
- **Failure to replace seat belts after an accident could leave you with damaged seat belts that will not provide protection in the event of another collision leading to personal injury or death. Replace your seat belts after being in an accident as soon as possible.**

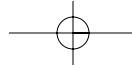

Safety system of your vehicle

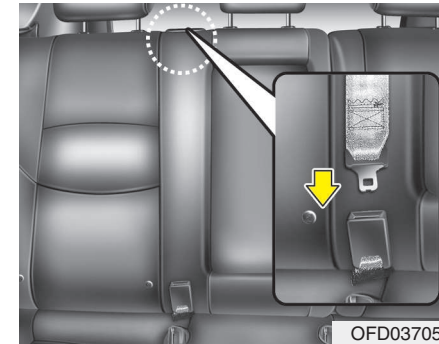
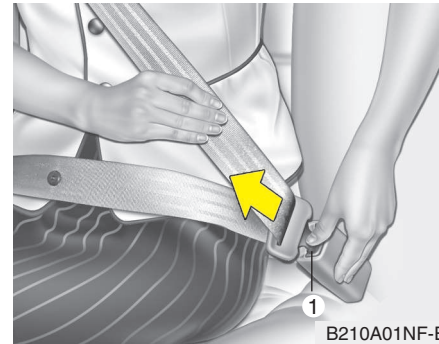
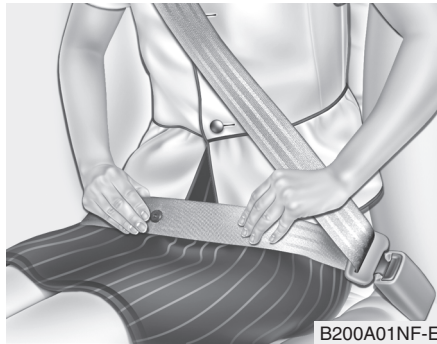

⚠ WARNING

You should place the lap belt portion as low as possible and snugly across your hips, not on your waist. If the lap belt is located too high on your waist, it may increase the chance of injury in the event of a collision. Both arms should not be under or over the belt. Rather, one should be over and the other under, as shown in the illustration.

Never wear the seat belt under the arm nearest the door.

To release the seat belt:

The seat belt is released by pressing the release button (1) in the locking buckle. When it is released, the belt should automatically draw back into the retractor.

If this does not happen, check the belt to be sure it is not twisted, then try again.

C020104AUN-UK

3-point rear centre seat belt (if equipped)

To fasten the rear centre seat belt:

1. Pull the webbing slowly out from the retractor on the top of the seatback to connect the rear centre belt.

⚠ CAUTION - Cargo

Be sure that cargo is securely loaded in the rear cargo area. Failing to do so may cause damage to the rear centre seat belt in sudden stops or collisions.

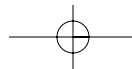

Safety system of your vehicle

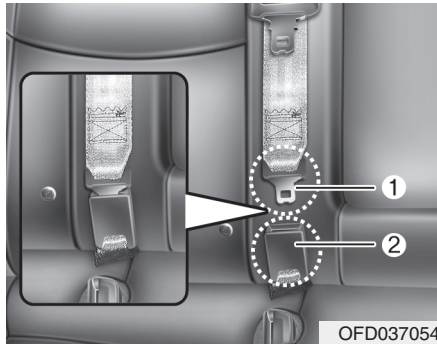

2. Insert the metal tab (1) into the open end of the anchor connector (2) until an audible “click” is heard, indicating the latch is locked. Make sure the belt is not twisted.

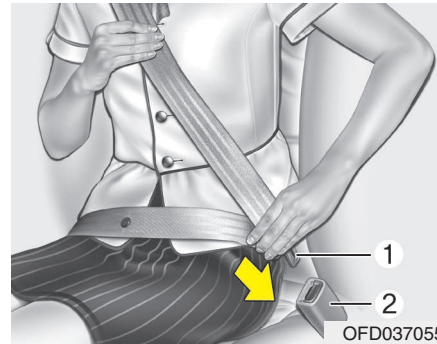

3. Pull the webbing and insert the tongue plate (1) into the open end of the buckle (2) until an audible “click” is heard, indicating the latch is locked. Make sure the belt is not twisted.

There will be an audible “click” when the tab locks in the buckle. The seat belt automatically adjusts to the proper length only after the lap belt is adjusted manually so that it fits snugly around your hips. If you lean forward in a slow, easy motion, the belt will extend and let you move around. If there is a sudden stop or impact, the belt will lock into position. It will also lock if you try to lean forward too quickly.

⚠ WARNING

Never let anyone ride in the rear centre seat without fastening all metal tab (or tongue plate) and anchor connector (or buckle) as described in this section. This seat belt is designed to function as a typical 3-point restraint (lap/shoulder belt). Using only the shoulder portion or lap portion of the belt can result in serious or fatal injuries in the event of a collision or sudden stop.

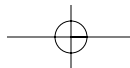

Safety system of your vehicle

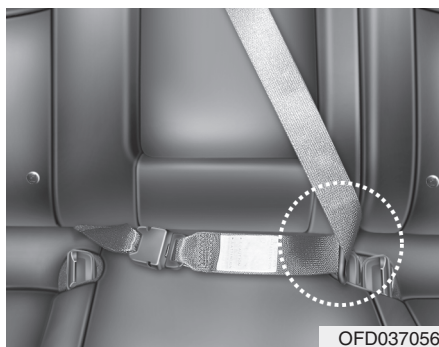

When using the rear centre seat belt, the buckle with the "CENTER" mark must be used.

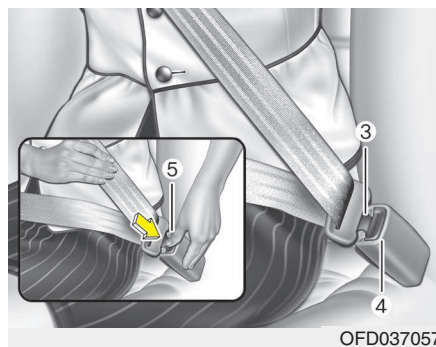

To unfasten the rear centre seat belt:

1. Press the release button (5) on the buckle (4) and remove the tongue plate (3) from the buckle (4).
2. Allow the webbing to draw back automatically into the retractor.

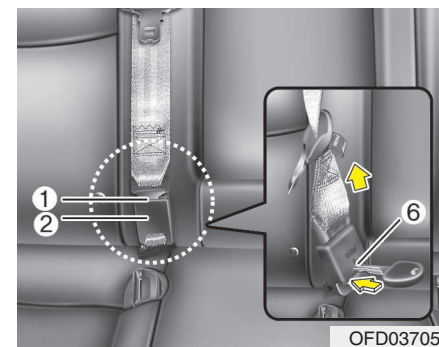

3. If necessary, disconnect the metal tab (1) from the anchor connector (2) by inserting a key or similar small rigid device into the release button (6) on the anchor connector (2) and allow the webbing to draw back automatically into the retractor.

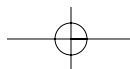

Safety system of your vehicle



OED030300/H

C020200AFD-UK

Pre-tensioner seat belt (if equipped)

The vehicle is equipped with driver and front passenger pre-tensioner seat belts. The pre-tensioner function ensures that the seat belts fit tightly against the occupant under certain impact conditions. The pre-tensioners work in conjunction with the airbags. If the severity of impact or the angle of impact is such that the airbags or pre-tensioners will not provide additional occupant protection, the system will not deploy.

If the occupant tries to lean forward too quickly, the seat belt retractor will lock into position. Under impact or braking conditions, seat belt retractor will lock. Depending upon the severity and angle of impact, the pre-tensioner may activate and will pull the seat belt into tighter contact against the occupant.

If the system senses excessive seat belt tension on the seat belt during pre-tensioner activation, the load limiter inside the pre-tensioner will release some of the pressure on the seat belt. (if equipped)

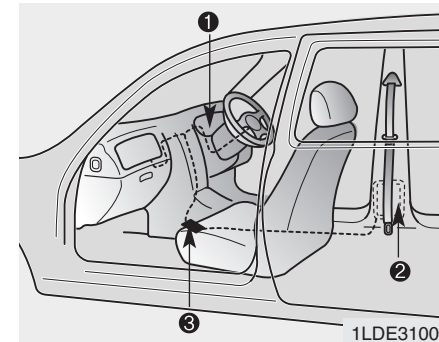

1LDE3100R

The seat belt pre-tensioner system consists mainly of the following components. Their locations are shown in the illustration:

1. SRS air bag warning light
2. Retractor pre-tensioner assembly
3. SRS control module

⚠ WARNING

To obtain maximum benefit from a pre-tensioner seat belt:

1. The seat belt must be working correctly and adjusted to the proper position. Please read and follow all of the important information and precautions about your vehicle's occupant safety features – including seat belts and air bags – that are provided in this manual.
2. Be sure you and your passengers always wear seat belts properly.

*** NOTICE**

- Both the driver and front passenger pre-tensioners activate in conjunction with the airbags according to the angle and severity of impact. The pre-tensioner seat belts will not activate where the angle or severity of impact is such that the system cannot provide additional occupant protection. The pre-tensioners will not be activated if the seat belts are not being worn at the time of impact.
- When the pre-tensioners are activated, a loud noise may be heard and fine dust, which may appear to be smoke, may be visible in the passenger compartment. These are normal operating conditions and are not hazardous.
- Although it is harmless, the fine dust may cause skin irritation and should not be breathed for prolonged periods. Wash all exposed skin areas thoroughly after an accident in which the pre-tensioners.

*** NOTICE**

Because the sensor that activates the SRS air bag is connected with the pre-tensioner seat belt, the SRS air bag warning light on the instrument panel will illuminate for approximately 6 seconds after the ignition switch has been turned to the "ON" position, and then it should turn off.

⚠ CAUTION

If the pre-tensioner seat belt is not working properly, this warning light will illuminate even if there is no malfunction of the SRS air bag. If the SRS air bag warning light does not illuminate when the ignition key is turned to "ON", or if it remains illuminated after illuminating for approximately 6 seconds, or if it illuminates whilst the vehicle is being driven, please have a HYUNDAI authorised repairer inspect the pre-tensioner seat belt or SRS air bag system as soon as possible.

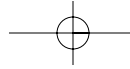

Safety system of your vehicle

⚠ WARNING

- Pre-tensioners are designed to operate only one time. After activation, pre-tensioner seat belts must be replaced. All seat belts, of any type, should always be replaced after they have been worn during a collision.
- The pre-tensioner seat belt assembly mechanisms become hot during activation. Do not touch the pre-tensioner seat belt assemblies for several minutes after they have been activated.
- Do not attempt to inspect or replace the pre-tensioner seat belts yourself. This must be done by a HYUNDAI authorised repairer.
- Do not strike the pre-tensioner seat belt assemblies.
- Improper handling of the pre-tensioner seat belt assemblies, and failure to heed the warnings not to strike, modify, inspect, replace, service or repair the pre-tensioner seat belt assemblies may lead to improper operation or inadvertent activation and serious injury.

(Continued)

(Continued)

- Always wear the seat belts when driving or riding in a motor vehicle.
- If the vehicle or pre-tensioner seat belt must be discarded, contact a HYUNDAI authorised repairer.

C020300AUN

Seat belt precautions

⚠ WARNING

All occupants of the vehicle must wear their seat belts at all times. Seat belts and child restraints reduce the risk of serious or fatal injuries for all occupants in the event of a collision or sudden stop. Without a seat belt, occupants could be shifted too close to a deploying air bag, strike the interior structure or be thrown from the vehicle. Properly worn seat belts greatly reduce these hazards. Always follow the precautions about seat belts, air bags and occupant seat contained in this manual.

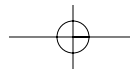
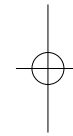
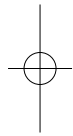

Safety system of your vehicle

C020306AUN

Infant or small child

You should be aware of the specific requirements in your country. Child and/or infant seats must be properly placed and installed in the rear seat. For more information about the use of these restraints, refer to “Child restraint system” in this section.

⚠ WARNING

Every person in your vehicle needs to be properly restrained at all times, including infants and children. Never hold a child in your arms or lap when riding in a vehicle. The violent forces created during a crash will tear the child from your arms and throw the child against the interior. Always use a child restraint appropriate for your child's height and weight.

*** NOTICE**

Small children are best protected from injury in an accident when properly restrained in the rear seat by a child restraint system that meets the requirements of the Safety Standards of your country. Before buying any child restraint system, make sure that it has a label certifying that it meets Safety Standards of your country. The restraint must be appropriate for your child's height and weight. Check the label on the child restraint for this information. Refer to “Child restraint system” in this section.

C020301AUN-UK

Larger children

Children who are too large for child restraint systems should always occupy the rear seat and use the available lap/shoulder belts. The lap portion should be fastened snugly on the hips and as low as possible. Check belt fit periodically. A child's squirming could put the belt out of position. Children are afforded the most safety in the event of an accident when they are restrained by a proper restraint system in the rear seat. If a larger child (over age 12) must be seated in the front seat, the child should be securely restrained by the available lap/shoulder belt and the seat should be placed in the rearmost position. Children age 12 and under should be restrained securely in the rear seat. NEVER place a child age 12 and under in the front seat. NEVER place a rear facing child seat in the front seat of a vehicle.

Safety system of your vehicle

If the shoulder belt portion slightly touches the child's neck or face, try placing the child closer to the centre of the vehicle. If the shoulder belt still touches their face or neck they need to be returned to a child restraint system.

⚠ WARNING - Shoulder belts on small children

- **Never allow a shoulder belt to be in contact with a child's neck or face whilst the vehicle is in motion.**
- **If seat belts are not properly worn and adjusted on children, there is a risk of death or serious injury.**

C020302AUN-UK

Pregnant women

The use of a seat belt is recommended for pregnant women. The seat belt should be worn as low and snugly as possible across the hips, not across the abdomen. A qualified Medical Practitioner should be consulted for further information.

C020303AUN-UK

Injured person

A seat belt should be used when an injured person is being transported. For specific recommendations, the advice of a qualified Medical Practitioner should be sought.

C020304AUN-UK

One person per belt

The seat belts are designed to be used by one seat occupant only. The use of a seat belt by more than one person increases the levels of injury which may be sustained in the event of an accident.

C020305AFD

Do not lie down

To reduce the chance of injuries in the event of an accident and to achieve maximum effectiveness of the restraint system, all passengers should be sitting up and the front seats should be in an upright position when the car is moving. A seat belt cannot provide proper protection if the person is lying down in the rear seat or if the front seat is in a reclined position.

⚠ WARNING

Riding with a reclined seatback increases your chance of serious or fatal injuries in the event of a collision or sudden stop. The protection of your restraint system (seat belts and air bags) is greatly reduced by reclining your seat. Seat belts must be snug against your hips and chest to work properly. The more the seatback is reclined, the greater the chance that an occupant's hips will slide under the lap belt causing serious internal injuries or the occupant's neck could strike the shoulder belt. Drivers and passengers should always sit well back in their seats, properly belted, and with the seatbacks upright.

C020400AUN-UK

Care of seat belts

Seat belt assemblies must never be disassembled or modified in any way. In addition, care should be exercised to ensure that the belt assemblies do not become damaged by being trapped in seat mechanisms, door shuts etc.

WARNING

When you return the rear seatback to its upright position after the rear seatback was folded down, be careful not to damage the seat belt webbing or buckle. Be sure that the webbing or buckle does not get caught or pinched in the rear seat. A seat belt with damaged webbing or buckle will not be as strong and could possibly fail during a collision or sudden stop, resulting in serious injury.

C020401AUN-UK

Periodic inspection

It is recommended that all seat belts be inspected periodically for wear or damage of any kind. Parts of the system that are damaged should be replaced as soon as possible. Under no circumstances must any part of the seat belt assemblies be dismantled or repaired.

C020402AUN-UK

Keep belts clean and dry

Seat belts should be kept clean and dry. If belts become dirty, they can be cleaned using a mild soap solution and warm water. Bleach, dye, strong detergents or abrasives should not be used since the fabric may become damaged and weakened.

C020403AFD-UK

When to replace seat belts

The entire seat belt assembly or assemblies should be inspected by an authorised repairer if the vehicle has been involved in an accident even if no damage is evident. Additional questions concerning seat belt operation should be directed to a Hyundai authorised repairer.

Safety system of your vehicle

CHILD RESTRAINT SYSTEM

C030000BUN-UK

Children riding in the car should sit in the rear seat and must always be properly restrained to minimise the risk of injury in an accident, sudden stop or sudden manoeuvre. According to accident statistics, children are safer when properly restrained in the rear seats than in the front seat. Larger children not in a child restraint should use one of the seat belts provided.

You should be aware of the specific requirements in your country. Child and/or infant safety seats must be properly placed and installed in the rear seat. You must use a commercially available child restraint system that meets the requirements of the Safety Standards of your country. Child restraint systems are designed to be secured in vehicle seats by lap belts or the lap belt portion of a lap/shoulder belt, or by a tether anchor and/or ISOFIX anchors (if equipped).

Children could be injured or killed in a crash if their restraints are not properly secured. For small children and babies, a child seat or infant seat must be used. Before buying a particular child restraint system, make sure it fits your car seat and seat belts, and fits your child. Follow all the instructions provided by the manufacturer when installing the child restraint system.

⚠ WARNING

- **A child restraint system must be placed in the rear seat. Never install a child or infant seat on the front passenger's seat. Should an accident occur and cause the passenger side air bag to deploy, it could severely injure or kill an infant or child seated in an infant or child seat. Thus only use a child restraint in the rear seat of your vehicle.**
- **A seat belt or child restraint system can become very hot if it is left in a closed vehicle on a sunny day, even if the outside temperature does not feel hot. Be sure to check the seat cover and buckles before placing a child there.**
- **When the child restraint system is not in use, store it in the luggage area or fasten it with a seat belt so that it will not be thrown forward in the case of a sudden stop or an accident.**
- **Children may be seriously injured or killed by an inflating air bag. All children, even those too large for child restraints, must ride in the rear seat.**

⚠ WARNING

To reduce the chance of serious or fatal injuries:

- **Children of all ages are safer when restrained in the rear seat. A child riding in the front passenger seat can be forcefully struck by an inflating air bag resulting in serious or fatal injuries.**
- **Always follow the instructions for installation and use of the child restraint maker.**
- **Always make sure the child seat is secured properly in the car and your child is securely restrained in the child seat.**
- **Never hold a child in your arms or lap when riding in a vehicle. The violent forces created during a crash will tear the child from your arms and throw the child against the car's interior.**
- **Never put a seat belt over yourself and a child. During a crash, the belt could press deep into the child causing serious internal injuries.**

(Continued)

Safety system of your vehicle

(Continued)

- Never leave children unattended in a vehicle – not even for a short time. The car can heat up very quickly, resulting in serious injuries to children inside. Even very young children may inadvertently cause the vehicle to move, entangle themselves in the windows, or lock themselves or others inside the vehicle.
- Never allow two children, or any two persons, to use the same seat belt.
- Children often squirm and reposition themselves improperly. Never let a child ride with the shoulder belt under their arm or behind their back. Always properly position and secure children in rear seat.
- Never allow a child to stand-up or kneel on the seat or floorboard of a moving vehicle. During a collision or sudden stop, the child can be violently thrown against the vehicles interior, resulting in serious injury.

(Continued)

(Continued)

- Never use an infant carrier or a child safety seat that "hooks" over a seatback, it may not provide adequate security in an accident.
- Seat belts can become very hot, especially when the car is parked in direct sunlight. Always check seat belt buckles before fastening them over a child.

Rearward-facing child restraint system

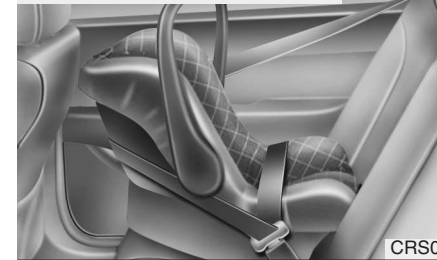

Forward-facing child restraint system



C030100AFD-UK

Using a child restraint system

For small children and babies, the use of a child seat or infant seat is required. This child seat or infant seat should be of appropriate size for the child and should be installed in accordance with the manufacturer's instructions. For safety reasons, we recommend that the child restraint system be used in the rear seats.

Safety system of your vehicle

⚠ WARNING

Never place a rear-facing child restraint in the front passenger seat, because of the danger that an inflating passenger-side air bag could impact the rear-facing child restraint and kill the child.

⚠ WARNING - Child seat installation

- Before installing the child restraint system, read the instructions supplied by the child restraint system manufacturer.
- If the seat belt does not operate as described in this section, have the system checked immediately by your HYUNDAI authorised repairer.
- Failure to observe this manual's instructions regarding child restraint system and the instructions provided with the child restraint system could increase the chance and/or severity of injury in an accident.

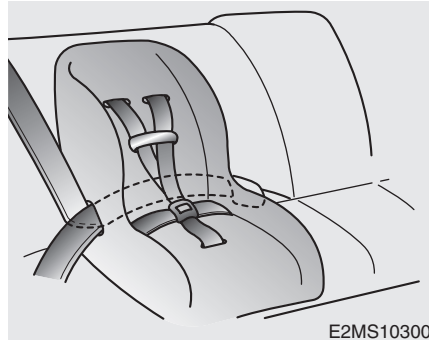

C030102AUN-UK

Installing a child restraint system by lap/shoulder belt

To install a child restraint system on the outboard or centre rear seats, do the following:

1. Place the child restraint system in the seat and route the lap/shoulder belt around or through the restraint, following the restraint manufacturer's instructions. Be sure the seat belt webbing is not twisted.

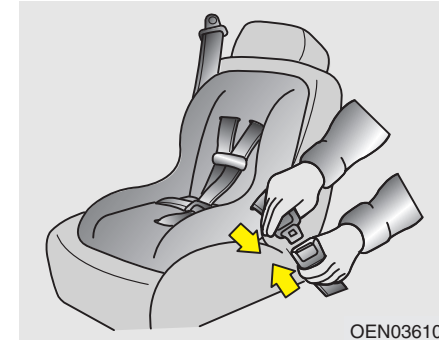

2. Fasten the lap/shoulder belt latch into the buckle. Listen for the distinct "click" sound.

Position the release button so that it is easy to access in case of an emergency.

Safety system of your vehicle



3. Buckle the seat belt and allow the seat belt to take up any slack. After installation of the child restraint system, try to move it in all directions to be sure the child restraint system is securely installed.

If you need to tighten the belt, pull more webbing toward the retractor. When you unbuckle the seat belt and allow it to retract, the retractor will automatically revert back to its normal seated passenger emergency locking usage condition.

C030105AFD-UK

Child seat restraint suitability for seat position using the seat belt

Use child safety seats that have been officially approved and are appropriate for your children. When using the child safety seats, refer to the following table.

<5 Door>

Age group	Seating position		
	Front passenger	Rear outboard	Rear centre
0 : Up to 10 kg (0 - 9 months)	U	U	U
0+ : Up to 13 kg (0 - 2 years)	U	U	U
I : 9 kg to 18 kg (9 months - 4 years)	U	U	U
II & III : 15 kg to 36 kg (4 - 12 years)	U	U	U

<Wagon>

Age group	Seating position		
	Front passenger	Rear outboard	Rear centre
0 : Up to 10 kg (0 - 9 months)	U	U	UF
0+ : Up to 13 kg (0 - 2 years)	U	U	UF
I : 9 kg to 18 kg (9 months - 4 years)	U	U	UF
II & III : 15 kg to 36 kg (4 - 12 years)	U	U	UF

U : Suitable for "universal" category restraints approved for use in this mass group

UF : Suitable for forward-facing "universal" category restraints approved for the use in this mass group

Safety system of your vehicle

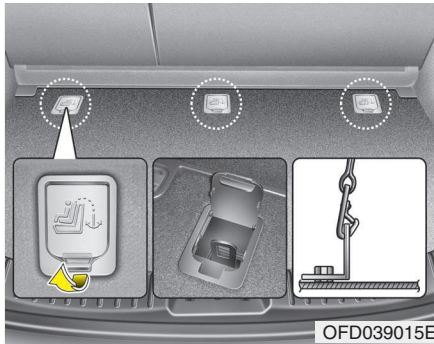

C030103AFD-UK

Securing a child restraint seat with “Tether Anchor” system (if equipped)

Child restraint hook holders are located on the floor behind the rear seats.



1. Route the child restraint seat strap over the seatback.
For vehicles with adjustable head restraint, route the tether strap under the head restraint and between the head restraint posts, otherwise route the tether strap over the top of the seatback.
2. Connect the tether strap hook to the appropriate child restraint hook holder and tighten to secure the seat.

⚠ WARNING

A child can be seriously injured or killed in a collision if the child restraint is not properly anchored to the car and the child is not properly restrained in the child restraint. Always follow the child seat manufacturer's instructions for installation and use.

⚠ WARNING - Tether strap

Never mount more than one child restraint to a single tether or to a single lower anchorage point. The increased load caused by multiple seats may cause the tethers or anchorage points to break, causing serious injury or death.

⚠ WARNING - Child restraint check

Check that the child restraint system is secure by pushing and pulling it in different directions. Incorrectly fitted child restraints may swing, twist, tip or separate causing death or serious injury.

⚠ WARNING - Child restraint anchorage

- Child restraint anchorages are designed to withstand only those loads imposed by correctly fitted child restraints. Under no circumstances are they to be used for adult seat belts or harnesses or for attaching other items or equipment to the vehicle.
- The tether strap may not work properly if attached somewhere other than the correct tether anchor.

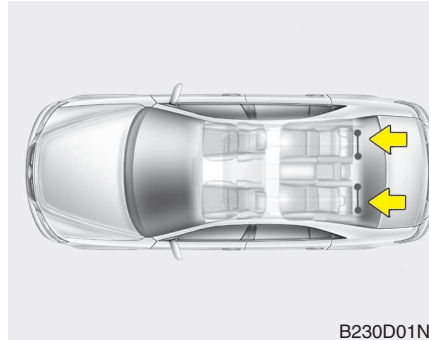

C030104AFD-UK

Securing a child restraint system with "ISOFIX" system and "Tether Anchorage" system (if equipped)

ISOFIX is a standardised method of fitting child seats that eliminates the need to use the standard adult seat belt to secure the seat in the vehicle. This enables a much more secure and positive location with the added benefit of easier and quicker installation.

An ISOFIX-seat can only be installed if it has vehicle-specific approval in accordance with the requirements of ECE-R44.

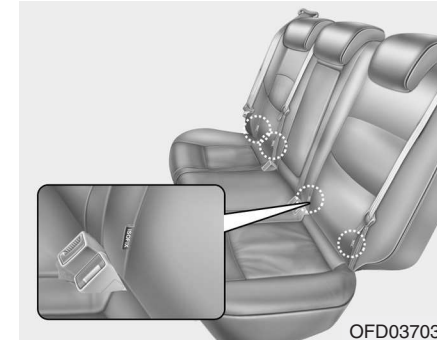

There are ISOFIX tags located on the lower portion of each side of the rear seatbacks. These tags indicate the position of the lower anchors for child restraints so equipped.

Safety system of your vehicle

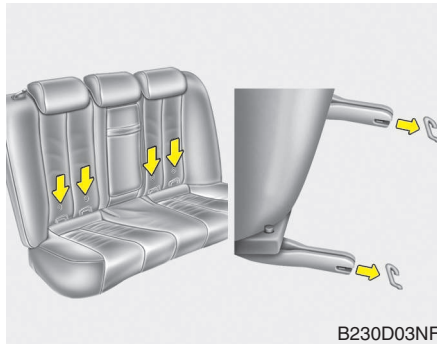

On each side of the rear seat, between the cushion and backrest, are located a pair of ISOFIX anchorage points together with a top tether mounting on the floor behind the rear seats. During the installation, the seat has to be engaged at the anchorage-points in a way you can hear it clicking (check by pulling!) and has to be fixed with the Top Tether-belt on the belonging point on the floor behind rear seats.

The installing and the use of a child-seat has to be done according to the installing-manual, which is added to the ISOFIX-seat.

⚠ WARNING
Install the child restraint seat fully rearward against the seatback with the seatback in a vertical position, not reclined.

⚠ WARNING
When using the vehicle's "ISOFIX" system to install a child restraint system in the rear seat, all unused vehicle rear seat belt metal latch plates or tabs must be latched securely in their seat belt buckles and the seat belt webbing must be retracted behind the child restraint to prevent the child from reaching and taking hold of unretracted seat belts. Unlatched metal latch plates or tabs may allow the child to reach the unretracted seat belts which may result in strangulation and a serious injury or death to the child in the child restraint.

To secure the child restraint seat

1. To engage the child restraint seat to the ISOFIX anchor, insert the child restraint seat latch into the ISOFIX anchor. Listen for the audible "click" sound.

⚠ CAUTION
Do not allow the rear seat belt webbing to get scratched or pinched by the ISOFIX-seat latch and ISOFIX anchor during the installation.

2. Connect the tether strap hook to the child restraint hook holder and tighten to secure the seat. (Refer to the previous page.)

⚠ WARNING

- Do not install a child restraint seat at the centre of the rear seat using the vehicle's ISOFIX anchors. The ISOFIX anchors are only provided for the left and right outboard rear seating positions. Do not misuse the ISOFIX anchors by attempting to attach a child restraint seat in the middle of the rear seat to the ISOFIX anchors.

In a crash, the child restraint seat ISOFIX attachments may not be strong enough to secure the child restraint seat properly in the centre of the rear seat and may break, causing serious injury or death.

- Do not mount more than one child restraint to a child restraint lower anchorage point. The improper increased load may cause the anchorage points or tether anchor to break, causing serious injury or death.

(Continued)

(Continued)

- Attach the ISOFIX or ISOFIX-compatible child restraint seat only to the appropriate locations shown in the illustration.
- Always follow the installation and use instructions provided by the manufacturer of the child restraint.

Safety system of your vehicle

C030106AFD-UK

Child seat restraint suitability for vehicle ISOFIX positions

Mass Group	Size Class	Fixture	vehicle ISOFIX positions			
			Front Passenger	Rear Outboard (Driver side)	Rear Outboard (Passenger side)	Rear Centre
Carrycot	F	ISO/L1	-	X	X	-
	G	ISO/L2	-	X	X	-
0 : UP to 10kg	E	ISO/R1	-	IUF	IUF	-
0+ : UP to 13kg	E	ISO/R1	-	IUF	IUF	-
	D	ISO/R2	-	IUF	IUF	-
	C	ISO/R3	-	IUF	IUF	-
I : 9 to 18kg	D	ISO/R2	-	IUF	IUF	-
	C	ISO/R3	-	IUF	IUF	-
	B	ISO/F2	-	IUF	IUF	-
	B1	ISO/F2X	-	IUF	IUF	-
	A	ISO/F3	-	IUF	IUF	-

IUF = Suitable for ISOFIX forward child restraints systems of universal category approved for use in the mass group.

X = ISOFIX position not suitable for ISOFIX child restraint system in this mass group and/or this size class.

* Both ISO/R2 and ISO/R3 are able to be set up only at the foremost position of the passenger seat.

* ISOFIX child restraint system size classes and fixtures

A - ISO/F3: Full-Height Forward-Facing toddler CRS (height 720mm)

B - ISO/F2: Reduced-Height Forward-Facing toddler CRS (height 650mm)

B1 - ISO/F2X: Reduced-Height Second Version Back Surface Shape Forward-Facing toddler CRS (height 650mm)

C - ISO/R3: Full-Size Rearward-Facing toddler CRS

D - ISO/R2: Reduced-Size Rearward-Facing toddler CRS

E - ISO/R1: Infant-Size Rearward-Facing CRS

F - ISO/L1: Left Lateral Facing position CRS (carry-cot)

G - ISO/L2: Right Lateral Facing position CRS (carry-cot)

Safety system of your vehicle

AIR BAG - SUPPLEMENTAL RESTRAINT SYSTEM (IF EQUIPPED)

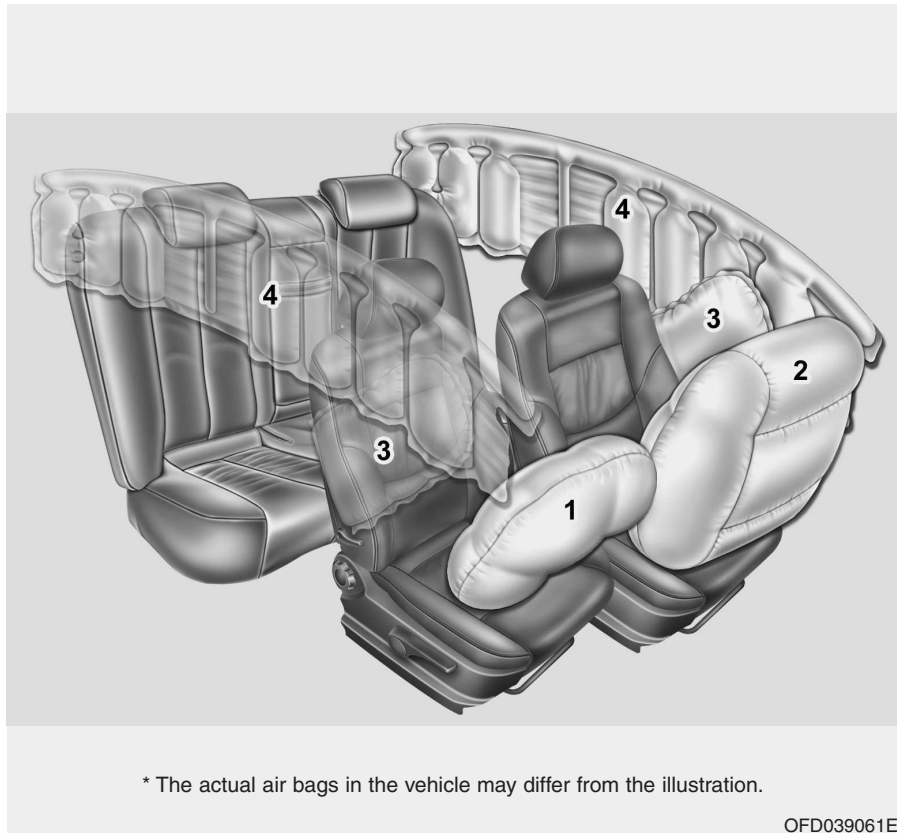

C040000AUN-UK

- (1) Driver's air bag
 - (2) Passenger's air bag*
 - (3) Side air bag*
 - (4) Curtain air bag*
- * : if equipped

⚠ WARNING

Even in vehicles with air bags, you and your passengers must always wear the safety belts provided in order to minimise the risk and severity of injury in the event of a collision or rollover.

* The actual air bags in the vehicle may differ from the illustration.

OFD039061ER

Safety system of your vehicle

C040100AFD-UK

SRS components and functions

The SRS consists of the following components:

1. Driver's front air bag module
2. Passenger's front air bag module*
3. Side air bag modules*
4. Curtain air bag modules*
5. Retractor pre-tensioner assemblies*
6. Air bag warning light
7. SRS control module (SRSCM)
8. Front impact sensors
9. Side impact sensors*
10. Passenger's front air bag OFF indicator (front passenger's seat only)*
11. Passenger's front air bag ON/OFF switch*

*: if equipped

The SRSCM continually monitors all elements whilst the ignition switch is ON to determine if a frontal or near-frontal impact is severe enough to require air bag deployment or pre-tensioner seat belt deployment.

The SRS air bag warning light on the instrument panel will illuminate for about 6 seconds after the ignition switch is turned to the ON position, after which the air bag warning light should go out.

If any of the following conditions occurs, this indicates a malfunction of the SRS. Have a HYUNDAI authorised repairer inspect the air bag system as soon as possible.

- The light does not turn on briefly when you turn the ignition ON.
- The light stays on after illuminating for approximately 6 seconds.
- The light comes on whilst the vehicle is in motion.

Driver's front air bag (1)



The air bag modules are located both in the centre of the steering wheel and in the front passenger's panel above the glove box. When the SRSCM detects a sufficiently severe impact to the front of the vehicle, it will automatically deploy the front air bags.

Safety system of your vehicle

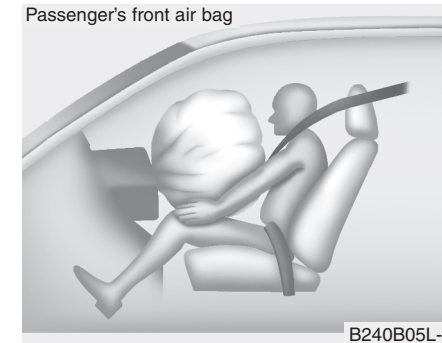
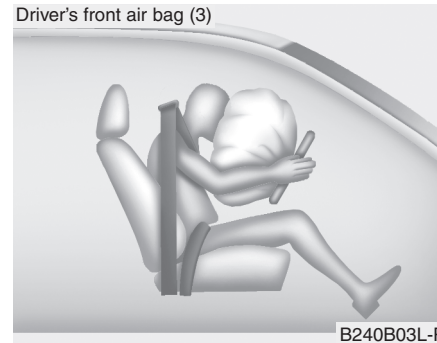
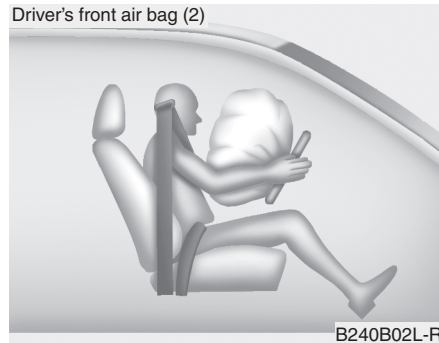

Upon deployment, tear seams molded directly into the pad covers will separate under pressure from the expansion of the air bags. Further opening of the covers then allows full inflation of the air bags.

A fully inflated air bag, in combination with a properly worn seat belt, slows the driver's or the passenger's forward motion, reducing the risk of head and chest injury.

After complete inflation, the air bag immediately starts deflating, enabling the driver to maintain forward visibility and the ability to steer or operate other controls.

⚠ WARNING

- Do not install or place any accessories (drink holder, CD holder, sticker, etc.) on the front passenger's panel above the glove box in a vehicle with a passenger's air bag. Such objects may become dangerous projectiles and cause injury if the passenger's air bag inflates.
- When installing a container of liquid air freshener inside the vehicle, do not place it near the instrument cluster nor on the instrument panel surface. It may become dangerous projectiles and cause injury if the passenger's air bag inflates.

Safety system of your vehicle

⚠ WARNING

- If an air bag deploys, there may be a loud noise followed by a fine dust released in the vehicle. These conditions are normal and are not hazardous - the air bags are packed in this fine powder. The dust generated during air bag deployment may cause skin or eye irritation as well as aggravate asthma for some persons. Always wash all exposed skin areas thoroughly with lukewarm water and a mild soap after an accident in which the air bags were deployed.

(Continued)

(Continued)

- The SRS can function only when the ignition key is in the "ON" position. If the SRS air bag warning light does not illuminate, or continuously remains on after illuminating for about 6 seconds when the ignition key is turned to the ON position, or after the engine is started, or after the engine is started, whilst driving, the SRS is not working properly. If this occurs, have your vehicle immediately inspected by a HYUNDAI authorised repairer.
- Before you replace a fuse or disconnect a battery terminal, turn the ignition switch to the LOCK position and remove the ignition key. Never remove or replace the air bag related fuse(s) when the ignition switch is in the ON position. Failure to heed this warning will cause the SRS air bag warning light to illuminate.



C040400BFD-UK

Driver's and passenger's front air bag (if equipped)

Your vehicle is equipped with a Supplemental Restraint (Air Bag) System and lap/shoulder belts at both the driver and passenger seating positions. The indications of the system's presence are the letters "SRS AIR BAG" embossed on the air bag pad cover in the steering wheel and the passenger's side front panel pad above the glove box.

The SRS consists of air bags installed under the pad covers in the centre of the steering wheel and the passenger's side front panel above the glove box.



The purpose of the SRS is to provide the vehicle's driver and/or the front passenger with additional protection than that offered by the seat belt system alone in case of a frontal impact of sufficient severity.

⚠ WARNING

Always use seat belts and child restraints – every trip, every time, everyone! Air bags inflate with considerable force and in the blink of an eye. Seat belts help keep occupants in proper position to obtain maximum benefit from the air bag. Even with air bags, improperly and unbelted occupants can be severely injured when the air bag inflates. Always follow the precautions about seat belts, air bags and occupant safety contained in this manual.

To reduce the chance of serious or fatal injuries and receive the maximum safety benefit from your restraint system:

- Never place a child in any child or booster seat in the front seat.
- ABC – Always Buckle Children in the back seat. It is the safest place for children of any age to ride.
- Front and side air bags can injure occupants improperly positioned in the front seats.

(Continued)

(Continued)

- Move your seat as far back as practical from the front air bags, whilst still maintaining control of the vehicle.
- You and your passengers should never sit or lean unnecessarily close to the air bags. Improperly positioned drivers and passengers can be severely injured by inflating air bags.
- Never lean against the door or centre console – always sit in an upright position.
- Do not allow a passenger to ride in the front seat when the passenger's front air bag OFF indicator is illuminated, because the air bag will not deploy in the event of a moderate or severe frontal crash.

(Continued)

Safety system of your vehicle

(Continued)

- No objects should be placed over or near the air bag modules on the steering wheel, instrument panel, and the front passenger's panel above the glove box, because any such object could cause harm if the vehicle is in a crash severe enough to cause the air bags to deploy.
- Do not tamper with or disconnect SRS wiring or other components of the SRS system. Doing so could result in injury, due to accidental deployment of the air bags or by rendering the SRS inoperative.
- If the SRS air bag warning light remains illuminated whilst the vehicle is being driven, have a HYUNDAI authorised repairer inspect the air bag system as soon as possible.

(Continued)

(Continued)

- Air bags can only be used once – have a HYUNDAI authorised repairer replace the air bag immediately after deployment.
- The SRS is designed to deploy the front air bags only when an impact is sufficiently severe and when the impact angle is less than 30° from the forward longitudinal axis of the vehicle. Additionally, the air bags will only deploy once. Seat belts must be worn at all times.
- Front air bags are not intended to deploy in side-impact, rear-impact or rollover crashes. In addition, front air bags will not deploy in frontal crashes below the deployment threshold.

(Continued)

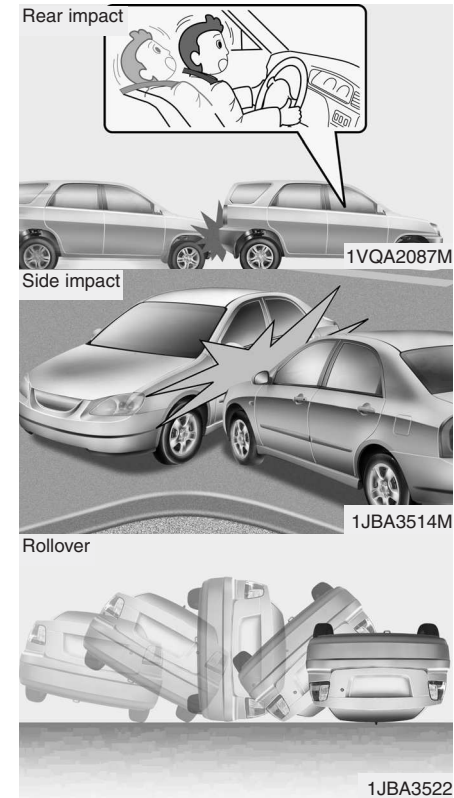

Safety system of your vehicle

(Continued)

- A child restraint system must never be placed in the front seat. The infant or child could be severely injured or killed by an air bag deployment in case of an accident.
- Children age 12 and under must always be properly restrained in the rear seat. Never allow children to ride in the front passenger seat. If a child over 12 must be seated in the front seat, he or she must be properly belted and the seat should be moved as far back as possible.
- For maximum safety protection in all types of crashes, all occupants including the driver should always wear their seat belts whether or not an air bag is also provided at their seating position to minimise the risk of severe injury or death in the event of a crash. Do not sit or lean unnecessarily close to the air bag whilst the vehicle is in motion.

(Continued)

(Continued)

- Sitting improperly or out of position can result in serious or fatal injury in a crash. All occupants should sit upright with the seat back in an upright position, centred on the seat cushion with their seat belt on, legs comfortably extended and their feet on the floor until the vehicle is parked and the ignition key is removed.
- The SRS air bag system must deploy very rapidly to provide protection in a crash. If an occupant is out of position because of not wearing a seat belt, the air bag may forcefully contact the occupant causing serious or fatal injuries.

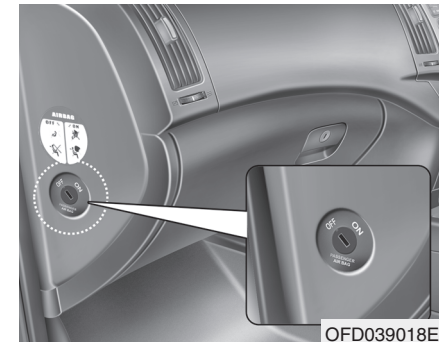

C040501AFD-UK

Passenger's front air bag ON/OFF switch (if equipped)

The passenger's front air bag can be deactivated by the passenger's front air bag ON/OFF switch if a child restraint is installed on the front passenger's seat or if the front passenger's seat is unoccupied by a person.

To ensure the safety of your child, the passenger's front air bag must be deactivated when it should be necessary to install a rearward facing child seat on the front passenger seat in exceptional circumstances.

Safety system of your vehicle

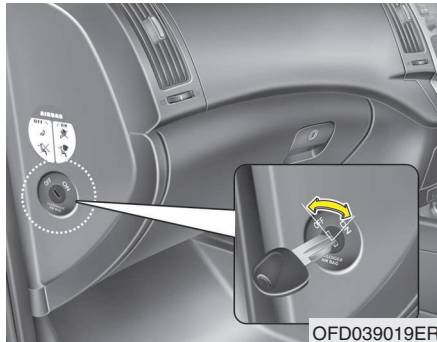

To deactivate or reactivate the passenger's front air bag:

To deactivate the passenger's front air bag, insert the master key into the passenger's front air bag ON/OFF switch and turn it to the OFF position. The passenger's front air bag OFF indicator will illuminate and stay on until the passenger's front air bag is reactivated.

To reactivate the passenger's front air bag, insert the master key into the passenger's front air bag ON/OFF switch and turn it to the ON position. The passenger's front air bag OFF indicator will go out.

⚠ WARNING

The front air bag ON/OFF switch could turn by using a similar small rigid device. Always check the status of the front air bag ON/OFF switch and passenger's front air bag OFF indicator.

*** NOTICE**

- When the passenger's front air bag ON/OFF switch is set to the ON position, the passenger's front air bag is activated and child or infant seat should not be installed on the front passenger seat.
- When the passenger's front air bag ON/OFF switch is set to the OFF position, the passenger's front air bag is deactivated.

⚠ CAUTION

- *If the passenger front air bag deactivation fails to operate properly, the air bag warning light on the instrument panel will illuminate.*
If the passenger front air bag OFF indicator does not illuminate, the passenger front air bag will remain activated and will deploy even if the passenger front air bag ON/OFF switch is set to the OFF position.
If this occurs, have a HYUNDAI authorised repairer inspect the passenger's front air bag ON/OFF switch, the pre-tensioner seat belt system and the SRS air bag system as soon as possible.
- *If the SRS air bag warning light does not illuminate when the ignition switch is turned to the ON position, or if it illuminates whilst the vehicle is being driven, have a HYUNDAI authorised repairer inspect the passenger's front air bag ON/OFF switch, pre-tensioner seat belt and the SRS air bag system as soon as possible.*

⚠ WARNING

- The driver is responsible for the proper position of the passenger's front air bag ON/OFF switch.
- Deactivate the passenger's front air bag only when the ignition switch is switched off, or the malfunction may occur in the SRS Control Module.
And there may be a danger that the driver's and/or front passenger's and/or side and curtain air bag may fail to trigger, or not trigger correctly during a collision.
- Never install a rearward facing child seat on the front passenger's seat unless the passenger's front air bag has been deactivated. The infant or child could be severely injured or killed by an air bag deployment in case of an accident.

(Continued)

(Continued)

- Even though your vehicle is equipped with the passenger's front air bag ON/OFF switch, do not install a child restraint system in the front passenger's seat. A child restraint system must never be placed in the front seat. Children who are too large for child restraint systems should always occupy the rear seat and use the available lap/shoulder belts. Children are afforded the most safety in the event of an accident when they are restrained by a proper restraint system in the rear seat.
- As soon as the child seat is no longer needed on the front passenger's seat, reactivate the front passenger's air bag.

⚠ WARNING

- The passenger's front air bag is much larger than the steering wheel air bag and inflates with considerably more force. It can seriously hurt or kill a passenger who is not in the proper position and wearing the seat belt properly. The front passengers should always move their seat as far back as practical and sit back in their seat.
- It is essential that the front passengers always wear their seat belts when vehicle is in motion, even when the vehicle is moving in a parking lot or up a driveway into garage.

(Continued)

Safety system of your vehicle

(Continued)

- If driver brakes the vehicle heavily in an urgent situations, occupants will be thrown forward. If front passengers are not wearing the seat belts, they will be directly in front of the air bags when inflation occurs. In that situation, severe injury or death is possible.
- Never allow front passenger to put their hands or feet on the instrument panel or put their face close to the instrument panel. The air bag will impact the front passenger when it inflates.

(Continued)

(Continued)

- Never allow children/old and feeble persons/pregnant women to sit on the front passenger's seat. Do not put child restraint system on the front passenger's seat either. They may be seriously injured by the air bag inflation when air bag deploys.
- Do not put objects or stickers on the instrument panel. Do not apply any accessory on the front windscreen glass or do not install aftermarket mirrors or accessories on the factory installed rearview mirror. These may interfere with the deployment of air bag inflation or could hit your body at high speed and cause severe bodily injury and even death.

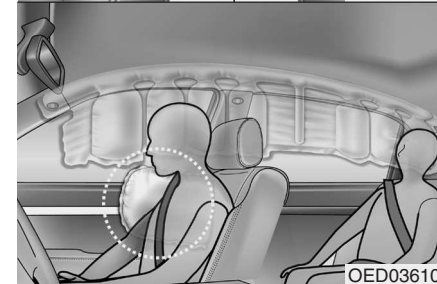
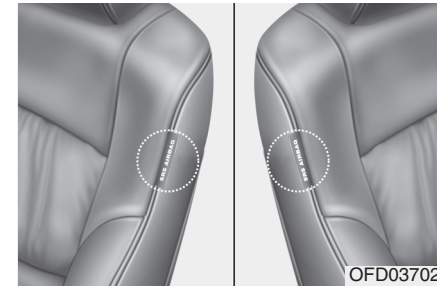

C040600AFD-UK

Side air bag (if equipped)

Your vehicle is equipped with a side air bag in each front seat. The purpose of the air bag is to provide the vehicle's driver and/or the front passenger with additional protection than that offered by the seat belt alone.

The side air bags are designed to deploy only during certain side-impact collisions, depending on the crash severity, angle, speed and point of impact. The side air bags are not designed to deploy in all side impact situations.

⚠ WARNING

- The side air bag is supplemental to the driver's and the passenger's seat belt systems and is not a substitute for them. Therefore your seat belts must be worn at all times whilst the vehicle is in motion. The air bags deploy only in certain side impact conditions severe enough to cause significant injury to the vehicle occupants.
- For best protection from the side air bag system and to avoid being injured by the deploying side air bag, both front seat occupants should sit in an upright position with the seat belt properly fastened. The driver's hands should be placed on the steering wheel at the 9:00 and 3:00 positions. The passenger's arms and hands should be placed on their laps.
- Do not use any accessory seat covers.
- Use of seat covers could reduce or prevent the effectiveness of the system.

(Continued)

(Continued)

- Do not install any accessories on the side or near the side air bag.
- Do not place any objects over the air bag or between the air bag and yourself.
- Do not place any objects (an umbrella, bag, etc.) between the front door and the front seat. Such objects may become dangerous projectiles and cause injury if the supplemental side air bag inflates.
- To prevent unexpected deployment of the side air bag that may result in personal injury, avoid impact to the side impact sensor when the ignition key is on.
- If seat or seat cover is damaged, have the vehicle checked and repaired by a HYUNDAI authorised repairer. Inform that your vehicle is equipped with side air bags.

Safety system of your vehicle



C040700AFD-UK

Curtain air bag (if equipped)

Curtain air bags are located along both sides of the roof rails above the front and rear doors.

They are designed to help protect the heads of the front seat occupants and the rear outboard seat occupants in certain side impact collisions.

The curtain air bags are designed to deploy only during certain side impact collisions, depending on the crash severity, angle, speed and impact. The curtain air bags are not designed to deploy in all side impact situations, collisions from the front or rear of the vehicle or in most rollover situations.

⚠ WARNING

- In order for side and curtain air bags to provide its best protection, both front seat occupants and both outboard rear occupants should sit in an upright position with the seat belts properly fastened. Importantly, children should sit in a proper child restraint system in the rear seat.
- When children are seated in the rear outboard seats, they must be seated in the proper child restraint system. Make sure to put the child restraint system as far away from the door side as possible, and secure the child restraint system in a locked position.

(Continued)

(Continued)

- Do not allow the passengers to lean their heads or bodies onto doors, put their arms on the doors, stretch their arms out of the window, or place objects between the doors and passengers when they are seated on seats equipped with side and/or curtain air bags.
- Never try to open or repair any components of the side curtain air bag system. This should only be done by a HYUNDAI authorised repairer.

Failure to follow the above mentioned instructions can result in injury or death to the vehicle occupants in an accident.

C040800AFD-UK

Air bag system operation (deployment/non deployment)

There are many types of situations in which an air bag would not provide additional protection to the vehicle occupants.

These include rear impacts, second or third collisions in multiple impact accidents, low speed impacts, offset collisions and vehicle roll over. It is therefore important to understand that the level of damage suffered by a vehicle as a result of impact is not indicative of whether air bag deployment was warranted by a primary, or subsequent, impact.

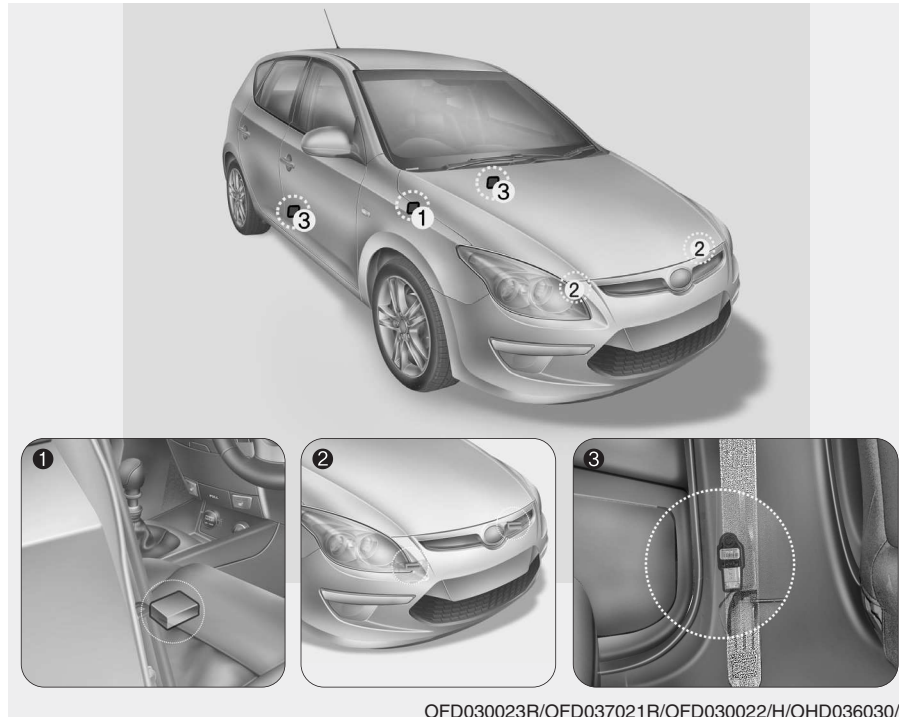

Air bag collision sensors

- (1) SRS control module
- (2) Front impact sensor

- (3) Side impact sensor (if equipped)

Safety system of your vehicle

⚠ WARNING

- Do not hit or allow any objects to impact the locations where air bag or sensors are installed.

This may cause unexpected air bag deployment, which could result in serious personal injury or death.

- If the installation location or angle of the sensors is altered in any way, the air bags may deploy when they should not or they may not deploy when they should, causing severe injury or death.

Therefore, do not try to perform maintenance on or around the air bag sensors. Have the vehicle checked and repaired by a HYUNDAI authorised repairer.

(Continued)

(Continued)

- Problems may arise if the sensor installation angles are changed due to the deformation of the front bumper, body or B pillar where side collision sensors are installed. Have the vehicle checked and repaired by a HYUNDAI authorised repairer.
- Your vehicle has been designed to absorb impact and deploy the air bag(s) in certain collisions. Installing aftermarket bumper guards or replacing a bumper with non-genuine parts may adversely affect your vehicles collision and air bag deployment performance.



C040801AUN

Air bag inflation conditions

Front air bag

Front air bags are designed to inflate in a frontal collision depending on the intensity, speed or angles of impact of the front collision.

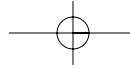

Safety system of your vehicle

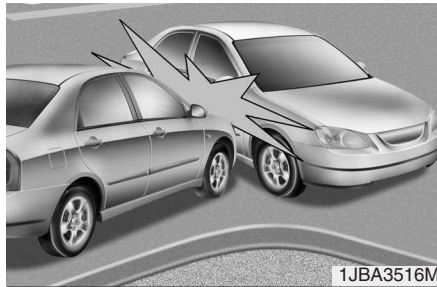

Although the front air bags (driver's and front passenger's air bags) are designed to inflate only in frontal collisions, they also may inflate in other types of collisions if the front impact sensors detect a sufficient impact. Side air bags (side and/or curtain air bags) are designed to inflate only in side impact collisions, but they may inflate in other collisions if the side impact sensors detect a sufficient impact.



Side air bags (if equipped)

Side and/or curtain air bags are designed to inflate when an impact is detected by side collision sensors depending on the strength, speed or angles of impact resulting from a side impact collision or rollover.



C040802AUN

Air bag non-inflation conditions

- In certain low-speed collisions the air bags may not deploy. The air bags are designed not to deploy in such cases because they may not provide benefits beyond the protection of the seat belts in such collisions.

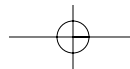

Safety system of your vehicle

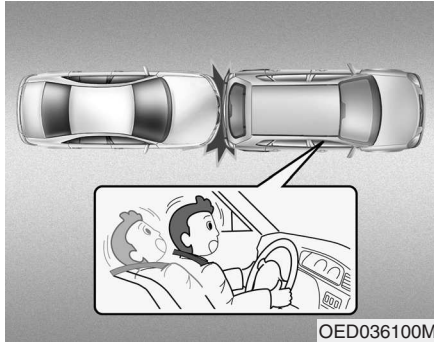

- Frontal air bags are not designed to inflate in rear collisions, because occupants are moved backward by the force of the impact. In this case, inflated air bags would not be able to provide any additional benefit.

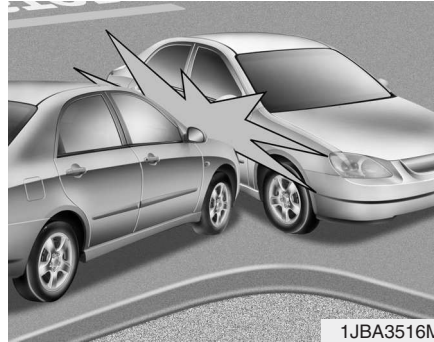

- Front air bags may not inflate in side impact collisions, because occupants move to the direction of the collision, and thus in side impacts, frontal air bag deployment would not provide additional occupant protection.
However, side or curtain air bags may inflate depending on the intensity, vehicle speed and angles of impact.

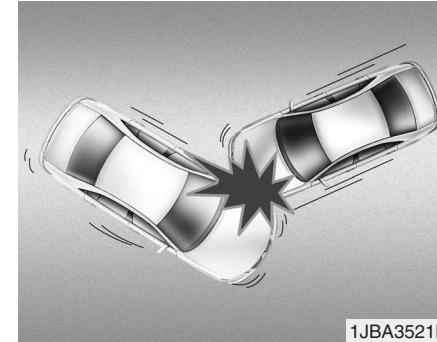

- In a slant or angled collision, the force of impact may direct the occupants in a direction where the air bags would not be able to provide any additional benefit, and thus the sensors may not deploy any air bags.

Safety system of your vehicle

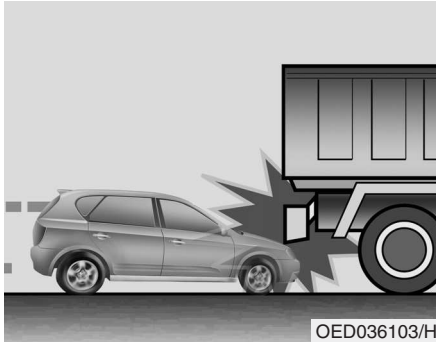

- Just before impact, drivers often brake heavily. Such heavy braking lowers the front portion of the vehicle causing it to “ride” under a vehicle with a higher ground clearance. Air bags may not inflate in this “under-ride” situation because deceleration forces that are detected by sensors may be significantly replaced by such “under-ride” collisions.

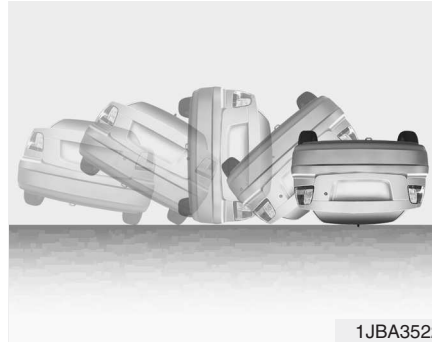

- Air bags may not inflate in rollover accidents because air bag deployment would not provide protection to the occupants. However, side and/or curtain air bags may inflate when the vehicle is rolled over by a side impact collision, if the vehicle is equipped with side air bags and curtain air bags.

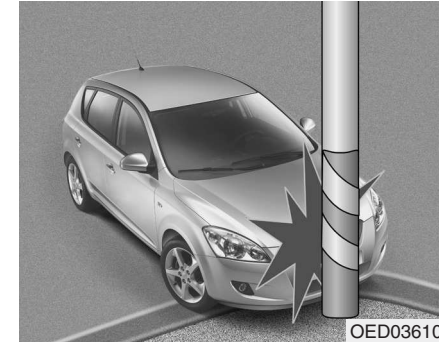

- Air bags may not inflate if the vehicle collides with objects such as utility poles or trees, where the point of impact is concentrated to one area and the full force of the impact is not delivered to the sensors.

Safety system of your vehicle

C040900AUN

How does the air bag system operate

- Air bags are activated (able to inflate if necessary) only when the ignition switch is turned to the ON or START position.
- Air bags inflate instantly in the event of serious frontal or side collision (if equipped with side air bag or curtain air bag) in order to help protect the occupants from serious physical injury.
- There is no single speed at which the air bags will inflate.

Generally, air bags are designed to inflate by the severity of a collision and its direction. These two factors determine whether the sensors send out an electronic deployment/inflation signal.

- Air bag deployment depends on a number of factors including vehicle speed, angles of impact and the density and stiffness of the vehicles or objects which your vehicle hits in the collision. Though, factors are not limited to those mentioned above.
- The front air bags will completely inflate and deflate in an instant.

It is virtually impossible for you to see the air bags inflate during an accident. It is much more likely that you will simply see the deflated air bags hanging out of their storage compartments after the collision.

- In order to help provide protection in a severe collision, the air bags must inflate rapidly. The speed of air bag inflation is a consequence of the extremely short time in which a collision occurs and the need to get the air bag between the occupant and the vehicle structures before the occupant impacts those structures. This speed of inflation reduces the risk of serious or life-threatening injuries in a severe collision and is thus a necessary part of air bag design.

However, air bag inflation can also cause injuries which normally can include facial abrasions, bruises and broken bones, and sometimes more severe injuries because the inflation speed also causes the air bags to expand with a great deal of force.

- **There are even circumstances under which contact with the steering wheel air bag can cause fatal injuries, especially if the occupant is positioned excessively close to the steering wheel.**

WARNING

- **To avoid severe personal injury or death caused by deploying air bags in a collision, the driver should sit as far back from the steering wheel air bag as possible (at least 10 inches (250 mm) away). The front passenger should always move their seat as far back as possible and sit back in their seat.**
- **Air bag inflates instantly in an event of collision, passengers may be injured by the air bag expansion force if they are not in proper position.**
- **Air bag inflation may cause injuries which normally include facial or bodily abrasions, injuries from broken glasses or burns by the air bag inflation gasses.**

C040902AUN

Noise and smoke

When the air bags inflate, they make a loud noise and they leave smoke and powder in the air inside of the vehicle. This is normal and is a result of the ignition of the air bag inflator. After the air bag inflates, you may feel substantial discomfort in breathing due to the contact of your chest to both the seat belt and the air bag, as well as from breathing the smoke and powder. **We strongly urge you to open your doors and/or windows as soon as possible after impact in order to reduce discomfort and prevent prolonged exposure to the smoke and powder.**

Though smoke and powder are non-toxic, it may cause irritation to the skin (eyes, nose and throat etc). If this is the case, wash and rinse with the cold water immediately and consult the doctor if the symptom persists.

⚠ WARNING
When the air bags deploy, the air bag related parts in steering wheel and/or instrument panel and/or in both sides of the roof rails above the front and rear doors are very hot. To prevent injury, do not touch the air bag storage areas internal components immediately after an air bag has inflated.



C040903AUN

Installing a child restraint on a front passenger's seat is forbidden

Never place a rear-facing child restraint in the front passenger's seat. If the air bag deploys, it would impact the rear-facing child restraint, causing serious or fatal injury.

In addition, do not place front-facing child restraint in the front passenger's seat either. If the front passenger air bag inflates, it would cause serious or fatal injuries to the child.

Safety system of your vehicle

⚠ WARNING

- **Extreme Hazard! Do not use a rearward facing child restraint on a seat protected by an air bag in front of it!**
- **Never put child restraint in the front passenger's seat. If the front passenger air bag inflates, it would cause serious or fatal injuries.**
- **When children are seated in the rear outboard seats in which side air bags are equipped, be sure to put the child restraint system as far away from the door side as possible, and secure the child restraint system to be locked in position.**
Inflation of side or curtain air bag could cause serious injury or death due to the expansion impact.



C041000AUN-UK

Air bag warning light

The purpose of air bag warning light in your instrument panel is to alert you of a potential problem with your air bag - Supplemental Restraint System (SRS).

When the ignition switch is turned ON, the indicator light should illuminate for approximately 6 seconds, then go off.

Have the system checked if:

- The light does not turn on briefly when you turn the ignition ON.
- The light stays on after illuminating for approximately 6 seconds.
- The light comes on whilst the vehicle is in motion.

C041100AFD-UK

SRS Care

The SRS is virtually maintenance-free and so there are no parts you can safely service by yourself. If the SRS air bag warning light does not illuminate, or continuously remains on, have your vehicle immediately inspected by a HYUNDAI authorised repairer.

Any work on the SRS system, such as removing, installing, repairing, or any work on the steering wheel must be performed by a HYUNDAI authorised repairer. Improper handling of the SRS system may result in serious personal injury.

⚠ WARNING

- **Modification to SRS components or wiring, including the addition of any kind of badges to the pad covers or modifications to the body structure, can adversely affect SRS performance and lead to possible injury.**
- **For cleaning the air bag pad covers, use only a soft, dry cloth or one which has been moistened with plain water. Solvents or cleaners could adversely affect the air bag covers and proper deployment of the system.**
- **No objects should be placed over or near the air bag modules on the steering wheel, instrument panel, and the front passenger's panel above the glove box, because any such object could cause harm if the vehicle is in a crash severe enough to cause the air bags to inflate.**

(Continued)

(Continued)

- **If the air bags inflate, they must be replaced by a HYUNDAI authorised repairer.**
- **Do not tamper with or disconnect SRS wiring, or other components of the SRS system. Doing so could result in injury, due to accidental inflation of the air bags or by rendering the SRS inoperative.**
- **If components of the air bag system must be discarded, or if the vehicle must be scrapped, certain safety precautions must be observed. A HYUNDAI authorised repairer knows these precautions and can give you the necessary information. Failure to follow these precautions and procedures could increase the risk of personal injury.**
- **If your car was flooded and has soaked carpeting or water on flooring, you shouldn't try to start the engine; have the car towed to a HYUNDAI authorised repairer.**

Safety system of your vehicle

C041300AUN-UK

Additional safety precautions

- **Never let passengers ride in the cargo area or on top of a folded-down back seat.** All occupants should sit upright, fully back in their seats with their seat belts on and their feet on the floor.
- **Passengers should not move out of or change seats whilst the vehicle is moving.** A passenger who is not wearing a seat belt during a crash or emergency stop can be thrown against the inside of the vehicle, against other occupants, or out of the vehicle.
- **Each seat belt is designed to restrain one occupant.** If more than one person uses the same seat belt, they could be seriously injured or killed in a collision.
- **Do not use any accessories on seat belts.** Devices claiming to improve occupant comfort or reposition the seat belt can reduce the protection provided by the seat belt and increase the chance of serious injury in a crash.
- **Passengers should not place hard or sharp objects between themselves and the air bags.** Carrying hard or sharp objects on your lap or in your mouth can result in injuries if an air bag inflates.

- **Keep occupants away from the air bag covers.** All occupants should sit upright, fully back in their seats with their seat belts on and their feet on the floor. If occupants are too close to the air bag covers, they could be injured if the air bags inflate.
- **Do not attach or place objects on or near the air bag covers.** Any object attached to or placed on the front or side air bag covers could interfere with the proper operation of the air bags.
- **Do not modify the front seats.** Modification of the front seats could interfere with the operation of the supplemental restraint system sensing components or side air bags.
- **Do not place items under the front seats.** Placing items under the front seats could interfere with the operation of the supplemental restraint system sensing components and wiring harnesses.
- **Never hold an infant or child on your lap.** The infant or child could be seriously injured or killed in the event of a crash. All infants and children should be properly restrained in appropriate child safety seats or seat belts in the rear seat.

WARNING

- **Sitting improperly or out of position can cause occupants to be shifted too close to a deploying air bag, strike the interior structure or be thrown from the vehicle resulting in serious injury or death.**
- **Always sit upright with the seat-back in an upright position, centred on the seat cushion with your seat belt on, legs comfortably extended and your feet on the floor.**

C041400AUN

Adding equipment to or modifying your air bag-equipped vehicle

If you modify your vehicle by changing your vehicle's frame, bumper system, front end or side sheet metal or ride height, this may affect the operation of your vehicle's air bag system.

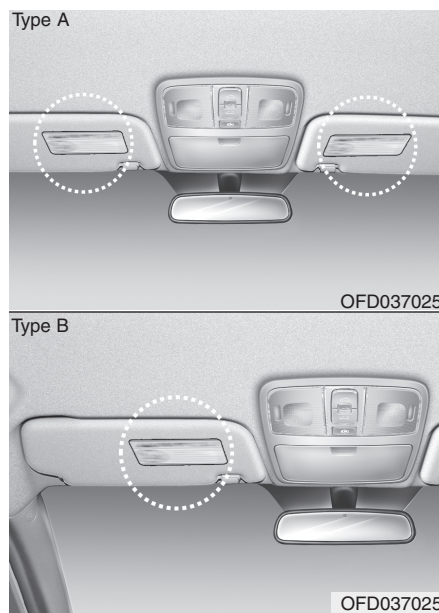

Note that these government warnings focus on the risk to children, we also wants you to be aware of the risks which adults are exposed to. Those have been described in previous pages.

C041200AUN-UK

Air bag warning label

Air bag warning labels are attached to alert driver and passengers (including children) of the potential risks from the air bag system.

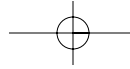

	Keys / 4-2 Remote keyless entry / 4-4 Theft-alarm system / 4-6 Door locks / 4-8 Tailgate / 4-12 Windows / 4-14 Bonnet / 4-19 Fuel filler lid / 4-21 Sunroof / 4-24
	Steering wheel / 4-28 Mirrors / 4-30 Instrument cluster / 4-34 Rear parking assist system / 4-54 Hazard warning flasher / 4-57 Lighting / 4-58 Wipers and washers / 4-64 Interior light / 4-68 Defroster / 4-70 Manual climate control system / 4-72 Automatic climate control system / 4-81 Windscreen defrosting and defogging / 4-89 Storage compartment / 4-93 Interior features / 4-97 Exterior features / 4-106 Audio system / 4-108

Features of your vehicle

4

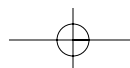
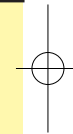
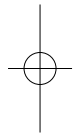

Features of your vehicle

KEYS



OFD047001UK

D010100AFD-UK

Record your key number

The key code number is stamped on the bar code tag attached to the key set. Should you lose your keys, this number will enable a HYUNDAI authorised repairer to duplicate the keys easily. Remove the bar code tag and store it in a safe place. Also, record the code number and keep it in a safe and handy place, but not in the vehicle.

D010200AFD

Key operations

Used to start the engine, lock and unlock the doors.

⚠ WARNING - Ignition key

Leaving children unattended in a vehicle with the ignition key is dangerous even if the key is not in the ignition. Children copy adults and they could place the key in the ignition. The ignition key would enable children to operate power windows or other controls, or even make the vehicle move, which could result in serious bodily injury or even death. **Never leave the keys in your vehicle with unsupervised children.**

⚠ WARNING

Use only HYUNDAI original parts for the ignition key in your vehicle. If an aftermarket key is used, the ignition switch may not return to ON after START. If this happens, the starter will continue to operate causing damage to the starter motor and possible fire due to excessive current in the wiring.



OFD047001-B

D010300AFD-UK

Immobiliser system

Your vehicle is equipped with an electronic engine immobiliser system to reduce the risk of unauthorised vehicle use.

Your immobiliser system is comprised of a small transponder in the ignition key, and antenna coil in the key cylinder and Immobiliser Control Unit (or Smartra Unit).

With this system, whenever you insert your ignition key into the ignition switch and turn it to ON, the antenna coil in the ignition switch receives a signal from the transponder in the ignition key and then sends the signal to the ECU (Engine Control Unit).

The ECU checks the signal whether the ignition key is valid. If the key is determined to be valid, the engine will start. If the key is determined to be invalid, the engine will not start.

To deactivate the immobiliser system:

Insert the ignition key into the key cylinder and turn it to the ON position.

To activate the immobiliser system:

Turn the ignition key to the OFF position. The immobiliser system activates automatically. Without a valid ignition key for your vehicle, the engine will not start.

⚠ WARNING

In order to prevent theft of your vehicle, do not leave spare keys anywhere in your vehicle. Your immobiliser password is a customer unique password and should be kept confidential. Do not leave this number anywhere in your vehicle.

*** NOTICE**

The immobiliser system detects the presence of a key in the ignition switch. To ensure the system performs correctly, the keys should be separated after delivery of the vehicle so that only one key is near the ignition switch when using the vehicle. The engine may not start or may stop shortly after starting if more than one key is near the ignition switch.

⚠ CAUTION

Do not put metal accessories near the ignition switch.

The engine may not start for the metal accessories may interrupt the transponder signal from normally transmitting.

*** NOTICE**

If you need additional keys or lose your keys, consult a HYUNDAI authorised repairer.

⚠ CAUTION

The transponder in your ignition key is an important part of the immobiliser system. It is designed to give years of trouble-free service, however you should avoid exposure to moisture, static electricity and rough handling. Immobiliser system malfunction could occur.

⚠ CAUTION

Do not change, alter or adjust the immobiliser system because it could cause the immobiliser system to malfunction and should only be serviced by a HYUNDAI authorised repairer.

Malfunctions caused by improper alterations, adjustments or modifications to the immobiliser system are not covered by your vehicle manufacturer warranty.

Features of your vehicle

REMOTE KEYLESS ENTRY (IF EQUIPPED)

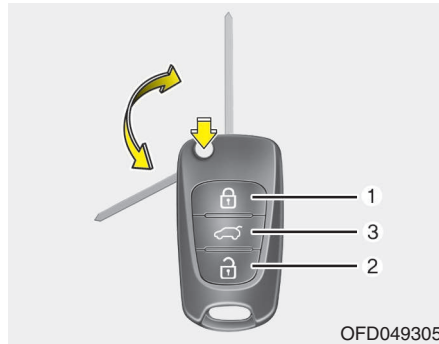

Remote keyless entry system operations

To unfold the key, press the release button then the key will unfold automatically. To fold the key, fold the key manually whilst pressing the release button.

CAUTION

Do not fold the key without pressing the release button. This may damage the key.

D020101AUN-EE

Lock (1)

All doors are locked if the lock button is pressed.

If all doors are closed, the hazard warning lights blink once to indicate that all doors are locked. However, if any door remains open, the hazard warning lights will not blink. If all doors are closed after the lock button is pressed, the hazard warning lights blink.

D020102AUN

Unlock (2)

All doors are unlocked if the unlock button is pressed.

The hazard warning lights will blink twice to indicate that all doors are unlocked.

After depressing this button, the doors will be locked automatically unless you open any door within 30 seconds.

D020104AUN

Tailgate unlock (3)

The tailgate is unlocked if the button is pressed (for more than 0.5 seconds).

The hazard warning lights will blink twice to indicate that the tailgate is unlocked.

After depressing this button, the tailgate will be locked automatically unless you open the tailgate within 30 seconds.

Also, once the tailgate is opened and then closed, the tailgate will be locked automatically.

D020200AFD-UK

Transmitter precautions

*** NOTICE**

The transmitter will not work if any of the following occur:

- The ignition key is in ignition switch.
- You exceed the operating distance limit (about 30 feet [10 m]).
- The battery in the transmitter is weak.
- Other vehicles or objects may be blocking the signal.
- The weather is extremely cold.
- The transmitter is close to a radio transmitter such as a radio station or an airport which can interfere with normal operation of the transmitter.

When the transmitter does not work correctly, open and close the door with the ignition key. If you have a problem with the transmitter, contact a **HYUNDAI** authorised repairer.

⚠ CAUTION

Keep the transmitter away from water or any liquid. If the keyless entry system is inoperative due to exposure to water or liquids, it will not be covered by your manufacturer vehicle warranty.



OFD047003

D020300BFD-UK

Battery replacement

Transmitter uses a 3 volt lithium battery which will normally last for several years. When replacement is necessary, use the following procedure.

1. Insert a slim tool into the slot and gently pry open the transmitter centre cover (1).
2. Replace the battery with new one. When replacing the battery, make sure the battery positive "+" symbol faces up as indicated in the illustration.
3. Install the battery in the reverse order of removal.

For replacement transmitters, see a HYUNDAI authorised repairer for reprogramming.

⚠ CAUTION

- *The keyless entry system transmitter is designed to give you years of trouble-free use, however it can malfunction if exposed to moisture or static electricity. If you are unsure how to use your transmitter or replace the battery, contact a HYUNDAI authorised repairer.*
- *Using the wrong battery can cause the transmitter to malfunction. Be sure to use the correct battery.*
- *To avoid damaging the transmitter, don't drop it, get it wet, or expose it to heat or sunlight.*

⚠ CAUTION

An inappropriately disposed battery can be harmful to the environment and human health. Dispose the battery according to your local law(s) or regulation.

Features of your vehicle

THEFT-ALARM SYSTEM (IF EQUIPPED)

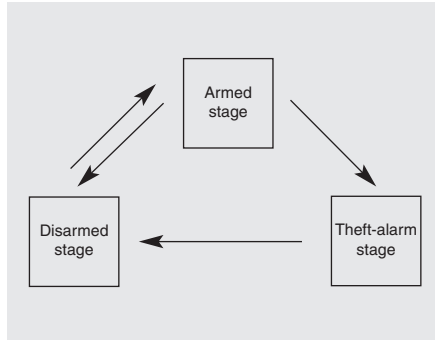

D030000AUN-UK

This system is designed to provide protection from unauthorised entry into the car. This system is operated in three stages: the first is the "Armed" stage, the second is the "Theft-alarm" stage, and the third is the "Disarmed" stage. If triggered, the system provides an audible alarm with blinking of the hazard warning lights.

D030100AUN-UK

Armed stage

Park the car and stop the engine. Arm the system as described below.

1. Remove the ignition key from the ignition switch and exit the vehicle.
2. Make sure that all doors (and tailgate) and the engine bonnet are closed and latched.
3. Lock the doors using the transmitter of the keyless entry system.

After completion of the steps above, the hazard warning lights will blink once to indicate that the system is armed.

If any door (or tailgate) or engine bonnet remains open, the hazard warning lights will not blink and the theft-alarm will not arm. If all doors (and tailgate) and engine bonnet are closed after the lock button is pressed, the hazard warning lights blink once.

- **Do not arm the system until all passengers have left the vehicle. If the system is armed whilst a passenger(s) remains in the vehicle, the alarm may be activated when the remaining passenger(s) leave the vehicle. If any door (or tailgate) or engine bonnet is opened within 30 seconds after the system enters the armed stage, the system is disarmed to prevent unnecessary alarm.**

D030200AFD-UK

Theft-alarm stage

The alarm will be activated if any of the following occurs whilst the system is armed.

- A front or rear door is opened without using the transmitter.
- The tailgate is opened without using the transmitter.
- The engine bonnet is opened.

The siren will sound and the hazard warning lights will blink continuously for 27 seconds, unless the system is disarmed. To turn off the system, unlock the doors with the ignition key (*) or transmitter.

(*) : To enable the ignition key to function, consult your HYUNDAI authorised repairer.

D030400AFD-UK

Disarmed stage

The system will be disarmed when the doors are unlocked by depressing the unlock button on the transmitter.

After depressing unlock button, the hazard warning lights will blink twice to indicate that the system is disarmed.

After depressing unlock button, if any door is not opened within 30 seconds, the system will be rearmed.

* NOTICE

- If the system is not disarmed with the transmitter, insert the key into the ignition switch and start the engine. Then the system will be disarmed.
- If you lose your keys, consult your HYUNDAI authorised repairer.

CAUTION

Do not change, alter or adjust the theft-alarm system because it could cause the theft-alarm system to malfunction and should only be serviced by a HYUNDAI authorised repairer.

Malfunctions caused by improper alterations, adjustments or modifications to the theft-alarm system are not covered by your vehicle manufacturer warranty.

Features of your vehicle

DOOR LOCKS

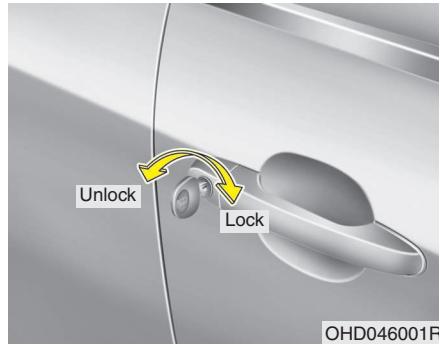

D050100AUN

Operating door locks from outside the vehicle

- Turn the key toward rear of vehicle to unlock and toward front of vehicle to lock.
- If you lock/unlock the door with a key, all vehicle doors will lock/unlock automatically.

- Doors can also be locked and unlocked with the transmitter key (if equipped).
- Once the doors are unlocked, they may be opened by pulling the door handle.
- When closing the door, push the door by hand. Make sure that doors are closed securely.

* If your vehicle is equipped with the remote keyless entry system, there is no key lock on the front passenger's door.

* NOTICE

- In cold and wet climates, door lock and door mechanisms may not work properly due to freezing conditions.
- If the door is locked/unlocked multiple times in rapid succession with either the vehicle key or door lock switch, the system may stop operating temporarily in order to protect the circuit and prevent damage to system components.

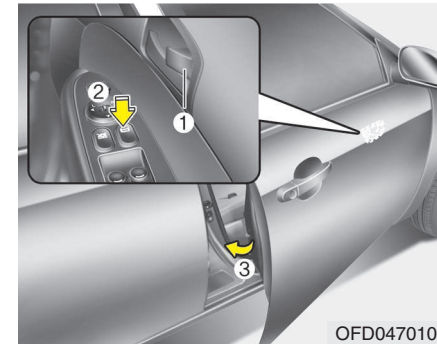

- To lock a door without the key, push the inside door lock button (1) or central door lock switch (2) to the "Lock" position and close the door (3).
- If you lock the door with the central door lock switch, all vehicle doors will lock automatically.

* NOTICE

Always remove the ignition key, engage the parking brake, close all windows and lock all doors when leaving your vehicle unattended.

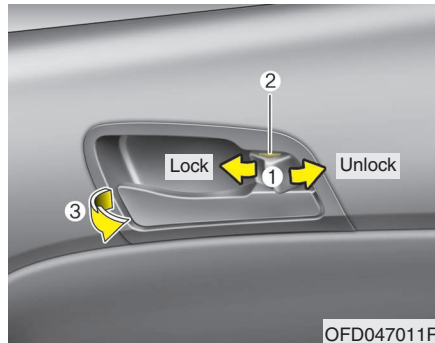

OFD047011R

Operating door locks from inside the vehicle

D050201AFD-UK

With the door lock button

- To unlock a door, push the door lock button (1) to the "Unlock" position. The red mark (2) on the button will be visible.
- To lock a door, push the door lock button (1) to the "Lock" position. If the door is locked properly, the red mark (2) on the door lock button will not be visible.
- To open a door, pull the door handle (3) outward.
- If the inner door handle of the front door is pulled when the door lock button is in lock position, the button is unlocked and door opens. (if equipped)

- Front doors cannot be locked if the ignition key is in the ignition switch and any front door is open.

⚠ WARNING - Door lock malfunction

If a power door lock ever fails to function whilst you are in the vehicle, try one or more of the following techniques to exit:

- Operate the door unlock feature repeatedly (both electronic and manual) whilst simultaneously pulling on the door handle.
- Operate the other door locks and handles, front and rear.
- Lower a front window and use the key to unlock the door from outside.
- If your vehicle is equipped with the tailgate safety release lever, move to the cargo area and open the tailgate.



OFD047012R

D050202AUN-UK

With central door lock switch

Operate by depressing the central door lock switch.

- When pushing down on the front portion (1) of the switch, all vehicle doors will lock.
- When pushing down on the rear portion (2) of the switch, all vehicle doors will unlock.
- However, if the key is in the ignition switch and any front door is open, the doors will not lock when the front portion of central door lock switch is pressed.

Features of your vehicle

WARNING - Doors

- The doors should always be fully closed and locked whilst the vehicle is in motion to prevent accidental opening of the door. Locked doors will also discourage potential intruders when the vehicle stops or slows.
- Be careful when opening doors and watch for vehicles, motorcycles, bicycles or pedestrians approaching the vehicle in the path of the door. Opening a door when something is approaching can cause damage or injury.

WARNING - Unlocked vehicles

Leaving your vehicle unlocked can invite theft or possible harm to you or others from someone hiding in your vehicle whilst you are gone. Always remove the ignition key, engage the parking brake, close all windows and lock all doors when leaving your vehicle unattended.

WARNING - Unattended children

An enclosed vehicle can become extremely hot, causing death or severe injury to unattended children or animals who cannot escape the vehicle. Furthermore, children might operate features of the vehicle that could injure them, or they could encounter other harm, possibly from someone gaining entry to the vehicle. Never leave children or animals unattended in your vehicle.

D050600ANF

Deadlocks (if equipped)

Some vehicles are equipped with a deadlocking system. Deadlocks prevent opening of a door from either inside or outside the vehicle once the deadlocks have been activated providing an additional measure of vehicle security.

To lock the vehicle using the deadlock function, the doors must be locked using the key or the Remote Keyless Entry transmitter. To unlock the vehicle, the key or the transmitter must again be used.

To lock a vehicle without using the deadlock function, the doors should be locked by depressing the central door lock switch and closing the doors.

WARNING

Occupants must not be allowed to remain in the vehicle when the deadlocking system is activated since it will not be possible for them, or persons outside the vehicle, to open the doors and leave the vehicle in case of an emergency.

D050300AUN-UK

Impact sensing door unlock system (if equipped)

All doors will be automatically unlocked when the impact is delivered to impact sensors whilst the ignition switch ON.

However, the doors may not be unlocked if mechanical problems occur with the door lock system or battery.

D050400AFD-UK

Speed sensing door lock system (if equipped)

Type A

When the speed of the vehicle keeps above 25 mph (40 km/h) for 1 second, it will automatically lock all doors. For activation of this feature, contact a HYUNDAI authorised repairer.

Type B

When the speed of the vehicle keeps above 9.3 mph (15 km/h) for 1 second, it will automatically lock all doors. For activation of this feature, contact a HYUNDAI authorised repairer.

* NOTICE

A HYUNDAI authorised repairer can select some auto door lock/unlock features as follows;

- Speed sensing auto door locking
- Auto door unlock when the ignition key is removed from the ignition switch

If you want to select a door lock/unlock feature, consult a HYUNDAI authorised repairer.

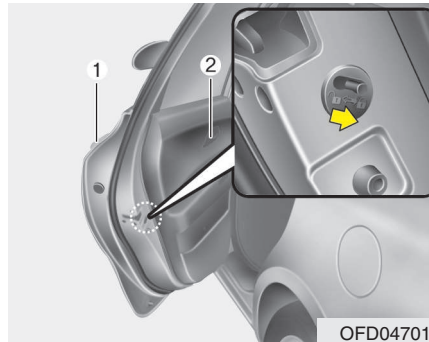

OFD047013

D050500AUN-UK

Child-protector rear door lock

The child safety lock is provided to help prevent children from accidentally opening the rear doors from inside the vehicle. The rear door safety locks should be used whenever children are in the vehicle.

1. Open the rear door.
2. Push the child safety lock located on the rear edge of the door to the "Lock" position. When the child safety lock is in the "Lock (🔒)" position, rear door will not open even though the inner door handle is pulled inside the vehicle.

3. Close the rear door.

To open the rear door, pull the outside door handle (1).

Even though the doors may be unlocked, the rear door will not open by pulling the inner door handle (2) until rear door child safety lock is unlocked (🔓).

⚠ WARNING - Rear door locks

If children accidentally open the rear doors whilst the vehicle is in motion, they could fall out and be severely injured or killed. To prevent children from opening the rear doors from the inside, the rear door safety locks should be used whenever children are in the vehicle.

Features of your vehicle

TAILGATE

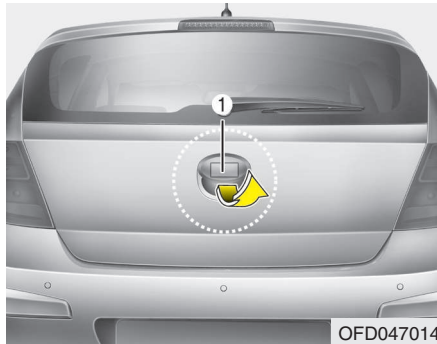

D070100AFD

Opening the tailgate

- The tailgate is locked or unlocked together if all doors are locked or unlocked with the key, transmitter or central door lock switch.
- The tailgate is unlocked alone for 30 seconds if the tailgate unlock button on the transmitter is pressed. Once the tailgate is opened and then closed, the tailgate is locked automatically.
- If unlocked, the tailgate can be opened by pressing the handle and pulling it up.

* NOTICE

In cold and wet climates, door lock and door mechanisms may not work properly due to freezing conditions.

⚠ WARNING

The tailgate swings upward. Make sure no objects or people are near the rear of the vehicle when opening the tailgate.

⚠ CAUTION

Make certain that you close the tailgate before driving your vehicle. Possible damage may occur to the tailgate lift cylinders and attaching hardware if the tailgate is not closed prior to driving.

D070200AUN

Closing the tailgate

To close the tailgate, lower and push down the tailgate firmly. Make sure that the tailgate is securely latched.

⚠ WARNING - Exhaust fumes

If you drive with the tailgate open, you will draw dangerous exhaust fumes into your vehicle which can cause serious injury or death to vehicle occupants.

If you must drive with the tailgate open, keep the air vents and all windows open so that additional outside air comes into the vehicle.

⚠ WARNING - Rear cargo area

Occupants should never ride in the rear cargo area where no restraints are available. To avoid injury in the event of an accident or sudden stops, occupants should always be properly restrained.

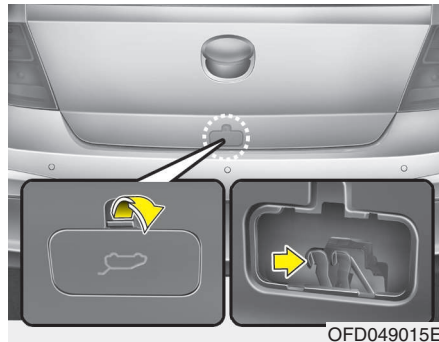

D070300AUN-UK

Emergency tailgate safety release lever (if equipped)

Your vehicle is equipped with emergency tailgate safety release lever located on the bottom of the tailgate. When someone is inadvertently locked in the luggage compartment, if the lever is pushed, the tailgate latch mechanism is released and the tailgate is opened by pushing backward.

⚠ WARNING

- For emergency, be fully aware of the location of the emergency tailgate safety release lever in their vehicle and how to open the tailgate if you are accidentally locked in the luggage compartment.
- No one should be allowed to occupy the luggage compartment of the vehicle at any time. The luggage compartment is a highly dangerous location in the event of a crash.
- Use the release lever for emergency only. Use extreme caution whilst the vehicle is in motion.

Features of your vehicle

WINDOWS

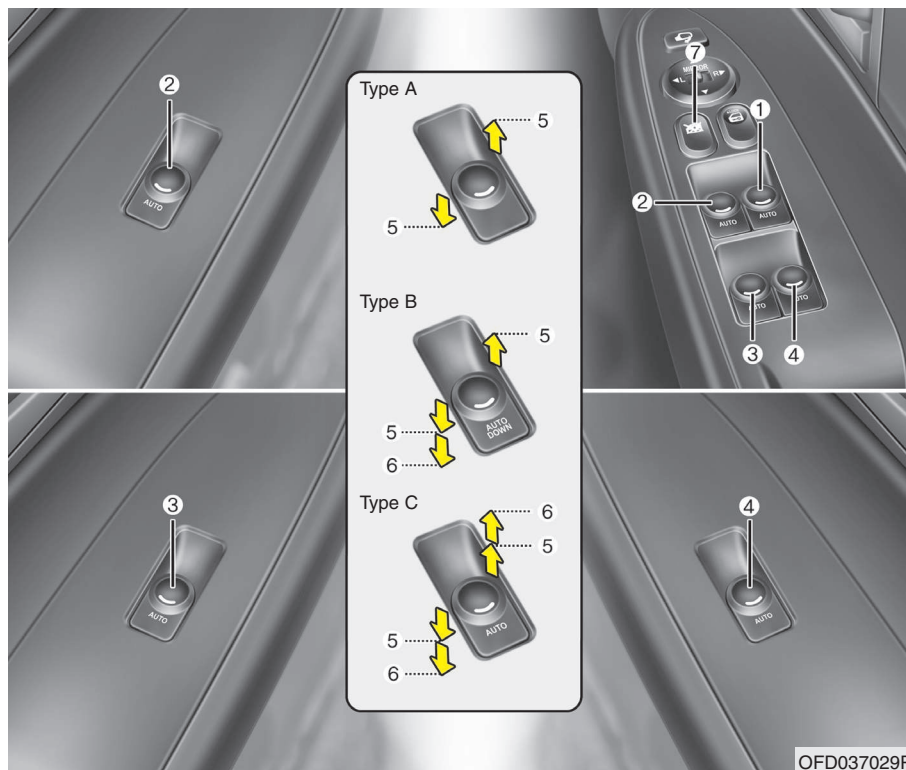

D080000AFD

- (1) Driver's door power window switch
- (2) Front passenger's door power window switch
- (3) Rear door (left) power window switch
- (4) Rear door (right) power window switch
- (5) Window opening and closing
- (6) Automatic power window up*/down*
- (7) Power window lock switch

*: if equipped

* NOTICE

In cold and wet climates, power windows may not work properly due to freezing conditions.

D080100BFD-UK

Power windows

The ignition switch must be in the ON position for power windows to operate. Each door has a power window switch that controls the door's window. The driver has a power window lock switch which can block the operation of rear passenger windows.

The power windows can be operated for approximately 30 seconds after the ignition key is removed or turned to the ACC or LOCK position. However, if the front doors are opened, the power windows cannot be operated even within the 30 seconds period after the ignition key removal.

* NOTICE

Whilst driving with the rear windows down or with the sunroof (if equipped) in an open (or partially open position), your vehicle may demonstrate a wind buffeting or pulsation noise. This noise is a normal occurrence and can be reduced or eliminated by taking the following actions. If the noise occurs with one or both of the rear windows down, partially lower both front windows approximately one inch. If you experience the noise with the sunroof open, slightly reduce the size of the sunroof opening.

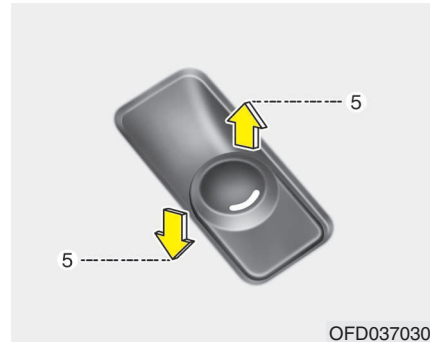

D080101AUN

Window opening and closing (if equipped)

The driver's door has a master power window switch that controls all the windows in the vehicle.

To open or close a window, press down or pull up the front portion of the corresponding switch to the first detent position (5).

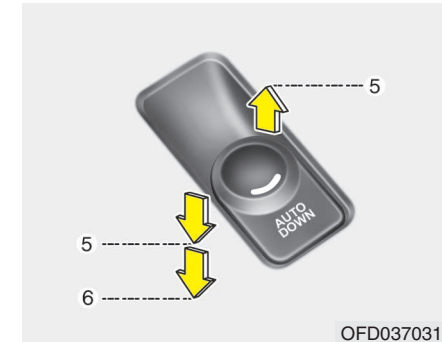

D080102AUN-UK

Auto down window (if equipped)

Depressing the power window switch momentarily to the second detent position (6) completely lowers the window even when the switch is released. To stop the window at the desired position whilst the window is in operation, pull up the switch momentarily to the opposite direction of the window movement.

Features of your vehicle



OFD037032R

D080103AUN-UK

Auto up/down window (if equipped)

Depressing or pulling up the power window switch momentarily to the second detent position (6) completely lowers or lifts the window even when the switch is released. To stop the window at the desired position whilst the window is in operation, pull up or depress and release the switch to the opposite direction of the movement.

If the power window is not operated correctly, the automatic power window system must be reset as follows:

1. Turn the ignition switch to the ON position.
2. Close the window and continue pulling up the power window switch for at least 1 second after the window is completely closed.

Automatic reversal

If the upward movement of the window is blocked by an object or part of the body, the window will detect the resistance and will stop upward movement. The window will then lower approximately 11.8 in. (30 cm) to allow the object to be cleared.

If the window detects the resistance whilst the power window switch is pulled up continuously, the window will stop upward movement then lower approximately 1 in. (2.5 cm). And if the power window switch is pulled up continuously again within 5 seconds after the window is lowered by the automatic window reversal feature, the automatic window reversal will not operate.

*** NOTICE**

The automatic reverse feature for the window is only active when the “auto up” feature is used by fully pulling up the switch. The automatic reverse feature will not operate if the window is raised using the halfway position on the power window switch.

⚠ WARNING

Always check for obstructions before raising any window to avoid injuries or vehicle damage. If an object less than 0.16 in. (4 mm) in diameter is caught between the window glass and the upper window channel, the automatic reverse window may not detect the resistance and will not stop and reverse direction.



D080104AUN-UK

OFD047020R

Power window lock button

- The driver can disable the power window switches on a rear passenger door by depressing the power window lock switch located on the driver's door to LOCK (pressed).
- **When the power window lock switch is ON, the driver's master control cannot operate the rear passenger door power windows.**

⚠ CAUTION

- *To prevent possible damage to the power window system, do not open or close two windows or more at the same time. This will also ensure the longevity of the fuse.*
- *Never try to operate the main switch on the driver's door and the individual door window switch in opposing directions at the same time. If this is done, the window will stop and cannot be opened or closed.*

⚠ WARNING - Windows

- **NEVER** leave the ignition key in the vehicle.
- **NEVER** leave any child unattended in the vehicle. Even very young children may inadvertently cause the vehicle to move, entangle themselves in the windows, or otherwise injure themselves or others.
- Always double check to make sure all arms, hands, head and other obstructions are safely out of the way before closing a window.
- Do not allow children to play with the power windows. Keep the driver's door power window lock switch in the LOCK position (depressed). Serious injury can result from unintentional window operation by the child.
- Do not extend face or arms outside through the window opening whilst driving.

Features of your vehicle

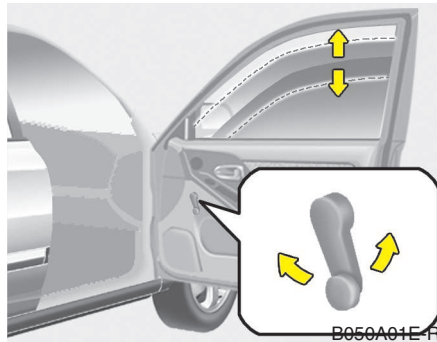

D080200AFD

Manual windows (if equipped)

To raise or lower the window, turn the window regulator handle clockwise or counterclockwise.

⚠ WARNING

When opening or closing the windows, make sure your passenger's arms, hands and body are safely out of the way.

BONNET

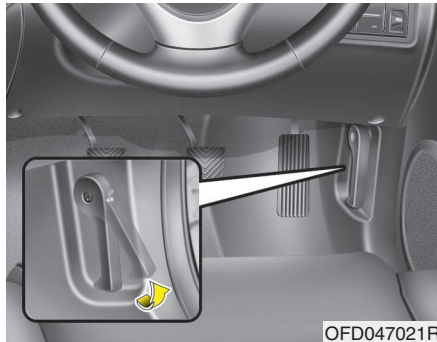

D090100AUN-UK

Opening the bonnet

1. Pull the release lever to unlatch the bonnet. The bonnet should pop open slightly.

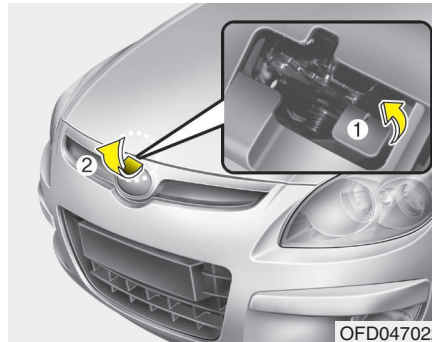

2. Go to the front of the vehicle, raise the bonnet slightly, pull the secondary latch (1) inside of the bonnet centre and lift the bonnet (2).

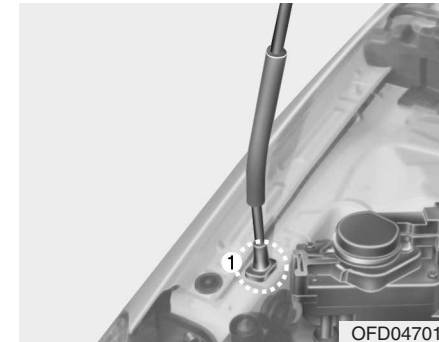

3. Pull the support rod from the bonnet.
4. Hold the bonnet open with the support rod.

⚠ WARNING - Hot parts
Grasp the support rod in the area wrapped in rubber. The rubber will help prevent you from being burned by hot metal when the engine is hot.

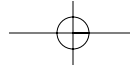

Features of your vehicle

D090200AUN-UK

Closing the bonnet

1. Before closing the bonnet, check the following:
 - All filler caps in engine compartment must be correctly installed.
 - Gloves, rags or any other combustible material must be removed from the engine compartment.
2. Return the support rod to its clip to prevent it from rattling.
3. Lower the bonnet until it is about 1 ft. (30 cm) above the closed position and let it drop. Make sure that it locks into place.

WARNING - Bonnet

- Before closing the bonnet, ensure that all obstructions are removed from the bonnet opening. Closing the bonnet with an obstruction present in the bonnet opening may result in property damage or severe personal injury.
- Do not leave gloves, rags or any other combustible material in the engine compartment. Doing so may cause a heat-induced fire.

WARNING

- Always double check to be sure that the bonnet is firmly latched before driving away. If it is not latched, the bonnet could fly open whilst the vehicle is being driven, causing a total loss of visibility, which might result in an accident.
- The support rod must be inserted completely into the hole provided in the bonnet whenever you inspect the engine compartment. This will prevent the bonnet from falling and possibly injuring you.
- Do not move the vehicle with the bonnet in the raised position, as vision is obstructed and the bonnet could fall or be damaged.

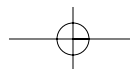
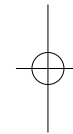
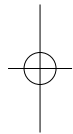

FUEL FILLER LID

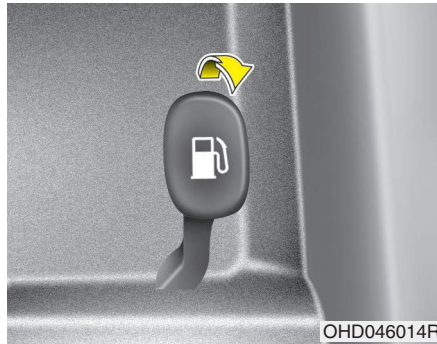

D100100AFD

Opening the fuel filler lid

The fuel-filler lid must be opened from inside the vehicle by pulling up on the fuel-filler lid opener located on the front floor area on the driver's seat.

* NOTICE

If the fuel-filler lid will not open because ice has formed around it, tap lightly or push on the lid to break the ice and release the lid. Do not pry on the lid. If necessary, spray around the lid with an approved de-icer fluid (do not use radiator anti-freeze) or move the vehicle to a warm place and allow the ice to melt.

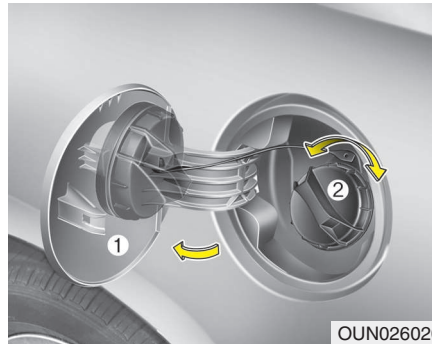

D100200AUN

Closing the fuel filler lid

1. To install the cap, turn it clockwise until it "clicks". This indicates that the cap is securely tightened.
2. Close the fuel filler lid and push it lightly and make sure that it is securely closed.

1. Stop the engine.
2. To open the fuel filler lid, pull the fuel filler lid opener up.
3. Pull the fuel filler lid (1) out to fully open.
4. To remove the cap (2), turn the fuel tank cap counterclockwise.
5. Refuel as needed.

Features of your vehicle

D100300AFD-UK

WARNING - Refuelling

- If pressurised fuel sprays out, it can cover your clothes or skin and thus subject you to the risk of fire and burns. Always remove the fuel cap carefully and slowly. If the cap is venting fuel or if you hear a hissing sound, wait until the condition stops before completely removing the cap.
- Do not "top off" after the nozzle automatically shuts off when refuelling.
- Always check that the fuel cap is installed securely to prevent fuel spillage in the event of an accident.

WARNING - Refuelling dangers

Automotive fuels are flammable materials. When refuelling, please note the following guidelines carefully. Failure to follow these guidelines may result in severe personal injury, severe burns or death by fire or explosion.

- Read and follow all warning at the fuel station facility.
- Before refuelling note the location of the Emergency Fuel Shut-Off, if available, at the fuel station facility.
- Before touching the fuel nozzle, you should eliminate potentially dangerous static electricity discharge by touching another metal part of the vehicle, a safe distance away from the fuel filler neck, nozzle, or other fuel source.

(Continued)

(Continued)

- Do not get back into a vehicle once you have begun refuelling since you can generate static electricity by touching, rubbing or sliding against any item or fabric (polyester, satin, nylon, etc.) capable of producing static electricity. Static electricity discharge can ignite fuel vapours resulting in rapid burning. If you must re-enter the vehicle, you should once again eliminate potentially dangerous static electricity discharge by touching a metal part of the vehicle, away from the fuel filler neck, nozzle or other fuel source.
- When using a portable fuel container be sure to place the container on the ground prior to refuelling. Static electricity discharge from the container can ignite fuel vapours causing a fire. Once refuelling has begun, contact with the vehicle should be maintained until the filling is complete.

(Continued)

Features of your vehicle

(Continued)

- Use only portable plastic fuel containers designed to carry and store fuel.
- Do not use mobile phones whilst refuelling. Electric current and/or electronic interference from mobile phones can potentially ignite fuel vapours causing a fire.
- When refuelling, always shut the engine off. Sparks produced by electrical components related to the engine can ignite fuel vapours causing a fire. Always insure that the engine is OFF before and during refuelling. Once refuelling is complete, check to make sure the filler cap and filler door are securely closed, before starting the engine.
- DO NOT use matches or a lighter and DO NOT SMOKE or leave a lit cigarette in your vehicle whilst at a fuel station especially during refuelling. Automotive fuel is highly flammable and can, when ignited, result in fire.

(Continued)

(Continued)

- If a fire breaks out during refuelling, leave the vicinity of the vehicle, and immediately contact the manager of the fuel station and then contact the local fire department. Follow any safety instructions they provide.



CAUTION

- Make sure to refuel your vehicle according to the "Fuel requirements" suggested in section 1.
- If the fuel filler cap requires replacement, use only a genuine HYUNDAI cap or the equivalent specified for your vehicle. An incorrect fuel filler cap can result in a serious malfunction of the fuel system or emission control system.

(Continued)

(Continued)

- Do not spill fuel on the exterior surfaces of the vehicle. Any type of fuel spilled on painted surfaces may damage the paint.
- After refuelling, make sure the fuel cap is installed securely to prevent fuel spillage in the event of an accident.

Features of your vehicle

SUNROOF (IF EQUIPPED)



OFD047023

D110000AUN-UK

If your vehicle is equipped with this feature, you can slide or tilt your sunroof with the sunroof control buttons located on the overhead console.

1. Slide button
2. Tilt button
3. Close button

The sunroof can only be opened, closed, or tilted when the ignition switch is in the ON position.

* NOTICE

- In cold and wet climates, sunroof may not work properly due to freezing conditions.
- After washing the car or after there is rain, be sure to wipe off any water that is on the sunroof before operating it.

⚠ CAUTION

Do not continue to press the sunroof control button(s) after the sunroof is in the fully open, closed, or tilt position(s). Damage to the motor or system components could occur.

* NOTICE

The sunroof cannot slide when it is in the tilt position nor can it be tilted whilst in an open or slide position.

⚠ WARNING

Never adjust the sunshade whilst driving. This could result in loss of control and an accident that may cause death, serious injury, or property damage.

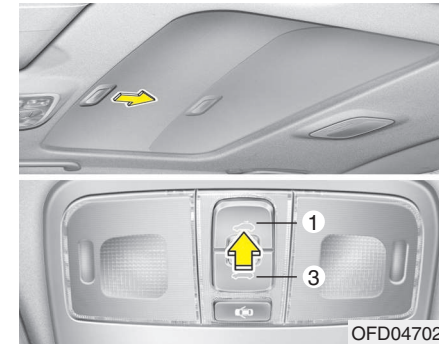

OFD047024

D110100AFD-UK

Sliding the sunroof

To open the sunroof (autoslide feature), press the slide button (1) on the overhead console for more than 0.5 second.

The sunroof will slide to the recommended open position (about 50mm before the maximum slide open position).

To stop the sunroof sliding at any point, press any sunroof control button.

To open the sunroof to the maximum slide open position, press the slide button (1) once again and hold it until the sunroof slide all the way open.

*** NOTICE**

To reduce wind noise whilst driving, we recommend you to drive at the recommended position (about 50mm before the maximum slide open position).

To close the sunroof (autoslide feature), press the close button (3) on the overhead console for more than 0.5 second. The sunroof will slide all the way close. To stop the sunroof sliding at any point, press any sunroof control button.

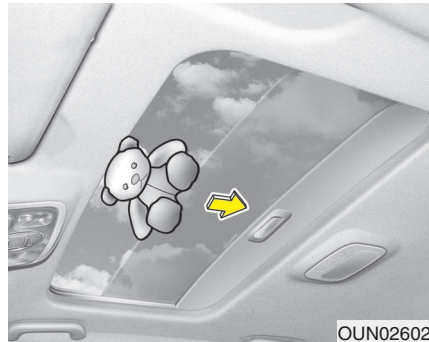

OUN026027

D110101AUN-UK

Automatic reversal

If an object or part of the body is detected whilst the sunroof is closing automatically, it will reverse direction, and then stop.

Auto reverse function does not work if a tiny obstacle is between the sliding glass and the sunroof sash. You should always check that all passengers and objects are away from the sunroof before closing it.



OFD047025

D110200AUN-UK

Tilting the sunroof

To open the sunroof (autotilt feature), press the tilt button (2) on the overhead console for more than 0.5 second.

The sunroof will tilt all the way open. To stop the sunroof tilting at any point, press any sunroof control button.

To close the sunroof, press the close button (3) on the overhead console and hold it until the sunroof is closed.

Features of your vehicle

⚠ WARNING - Sunroof

- Be careful that someone's head, hands and body are not trapped by a closing sunroof.
- Do not extend face, neck, arms or body outside through the sunroof opening whilst driving.
- Make sure hand and face are safely out of the way before closing a sunroof.

⚠ CAUTION

- *Periodically remove any dirt that may accumulate on the guide rail.*
- *If you try to open the sunroof when the temperature is below freezing or when the sunroof is covered with snow or ice, the glass or the motor could be damaged.*
- *The sunroof is made to slide together with sunshade. Do not leave the sunshade closed whilst the sunroof is open.*



D110300AUN

Sunshade

The sunshade will be opened with the glass panel automatically when the glass panel is slid. You will have to close it manually if you want it closed.

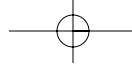

D110500AFD-UK

Resetting the sunroof

Whenever the vehicle battery is disconnected or discharged, or related fuse is blown, you must reset your sunroof system as follows:

1. Turn the ignition switch to the ON position and close the sunroof completely.
2. Release the control button.
3. Press and hold the close button until the sunroof tilts and slightly moves up and down. Then, release the button.
4. Press and hold the close button until the sunroof is operated as follows;

TILT DOWN → SLIDE OPEN →
SLIDE CLOSE

Then, release the control button.

When this is complete, the sunroof system is reset.

* For more detailed information, contact a HYUNDAI authorised repairer.

CAUTION

If the sunroof is not reset when the vehicle battery is disconnected or discharged, or related fuse is blown, the sunroof may operate improperly.

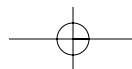
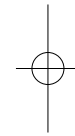
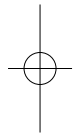

Features of your vehicle

STEERING WHEEL

D130200AFD-UK

Electric power steering

The power steering system employs an electric motor to provide steering assistance to the driver. Unlike conventional hydraulic systems, no engine driven pump or associated pipes are required which contributes to reduced operating noise and increased efficiency.

The electronic power steering provides variable assistance according to vehicle speed, steering wheel position and the effort (torque) being applied to the steering wheel by the driver.

The amount of assistance provided is greatest when the vehicle speed is very low and there is a progressive decrease in assistance as vehicle speed increases.

The system is maintenance free and there are no user serviceable parts within the steering system.

A warning light is provided to alert the driver of any abnormality detected within the system. Illumination of this lamp when the engine is running or any change in the effort required to steer the vehicle must be referred to the nearest Hyundai authorised repairer without delay.

* NOTICE

The following characteristics may be observed during normal vehicle operation:

- The EPS warning light should only be illuminated with the ignition ON before starting the engine.
- The steering may become heavier after turning the ignition switch on. This happens as the system performs the EPS system diagnostics. When the diagnostics is completed, the steering wheel will return to its normal condition.
- A click noise may be heard from the EPS relay after the ignition switch is turned to the ON or LOCK position.
- If the Electronic Power Steering System does not operate normally, the warning light will illuminate on the instrument cluster. The steering wheel may become difficult to control or operate abnormally. Take your vehicle to an authorised HYUNDAI dealer and have the vehicle checked as soon as possible.
- When you operate the steering wheel in low temperature, abnormal noise could occur. If temperature rises, the noise will disappear. This is a normal condition.

D130300AFD-UK

Adjustable steering column

The adjustable steering column permits adjustment of the rake and height of the steering wheel for the convenience of the driver.

The position of the steering wheel should be adjusted for maximum comfort and control whilst permitting a clear view of the instrument panel.

WARNING

- Never adjust the angle and height of steering wheel whilst driving. You may lose your steering control and cause severe personal injury or accidents.
- After adjusting, push the steering wheel both up and down to be certain it is locked in position.

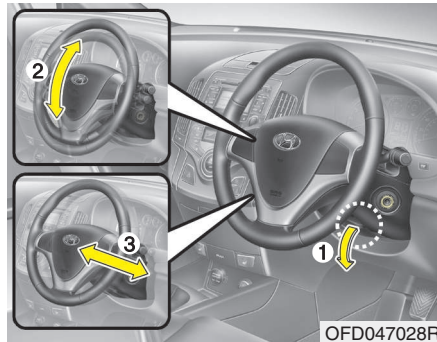

OFD047028R

To change the steering wheel angle, pull down the lock release lever (1), adjust the steering wheel to the desired angle (2) and height (if equipped) (3), then pull up the lock-release lever to lock the steering wheel in place. Be sure to adjust the steering wheel to the desired position before driving.

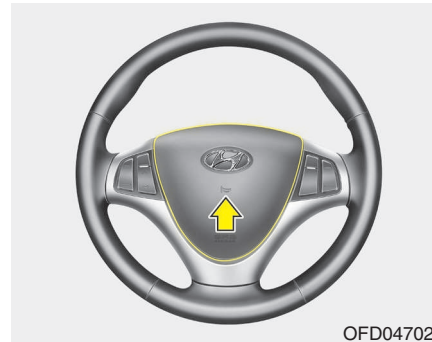

OFD047029

D130500AUN

Horn

To sound the horn, press the horn symbol on your steering wheel. Check the horn regularly to be sure it operates properly.

* NOTICE

To sound the horn, press the area indicated by the horn symbol on your steering wheel (see illustration). The horn will operate only when this area is pressed.



CAUTION

Do not strike the horn severely to operate it, or hit it with your fist. Do not press on the horn with a sharp-pointed object.

Features of your vehicle

MIRRORS

D140100AUN-UK

Inside rearview mirror

Adjust the rearview mirror to centre on the view through the rear window. Make this adjustment before you start driving.

⚠ WARNING - Rear visibility
Do not place objects in the rear seat or cargo area which would interfere with your vision out the rear window.

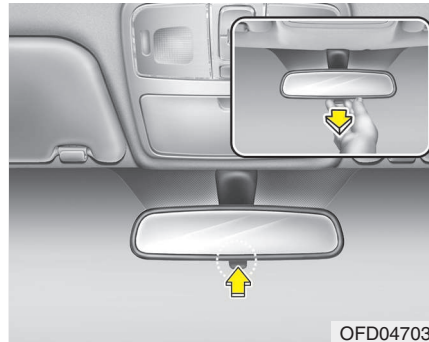

D140101AUN-UK

Day/night rearview mirror

Make this adjustment before you start driving and whilst the day/night lever is in the day position.

Pull the day/night lever toward you to reduce glare from the headlights of vehicles behind you during night driving.

Remember that you lose some rearview clarity in the night position.

D140102AUN

Electric chromic mirror (ECM) (if equipped)

The electric rearview mirror automatically controls the glare from the headlights of the car behind you in nighttime or low light driving conditions. The sensor mounted in the mirror senses the light level around the vehicle, and automatically controls the headlight glare from vehicles behind you.

When the engine is running, the glare is automatically controlled by the sensor mounted in the rearview mirror.

Whenever the shift lever is shifted into reverse (R), the mirror will automatically go to the brightest setting in order to improve the drivers view behind the vehicle.

⚠ CAUTION

When cleaning the mirror, use a paper towel or similar material dampened with glass cleaner. Do not spray glass cleaner directly on the mirror as that may cause the liquid cleaner to enter the mirror housing.



D140200AUN-UK

Outside rearview mirror

Be sure to adjust mirror angles before driving.

Your vehicle is equipped with both left-hand and right-hand outside rearview mirrors. The mirrors can be adjusted remotely with the remote switch. The mirror heads can be folded back to prevent damage during an automatic car wash or when passing in a narrow street.

To operate the electric rearview mirror

- Press the ON/OFF button (1) to turn the automatic dimming function on. The mirror indicator light will illuminate. Press the ON/OFF button to turn the automatic dimming function off. The mirror indicator light will turn off.
- The mirror defaults to the ON position whenever the ignition switch is turned on.

⚠ WARNING - Rearview mirrors

- **The right outside rearview mirror is convex. In some countries, the left outside rearview mirror is also convex. Objects seen in the mirror are closer than they appear.**
- **Use your interior rearview mirror or direct observation to determine the actual distance of following vehicles when changing lanes.**

⚠ CAUTION

Do not scrape ice off the mirror face; this may damage the surface of the glass. If ice should restrict movement of the mirror, do not force the mirror for adjustment. To remove ice, use a deicer spray, or a sponge or soft cloth with very warm water.

Features of your vehicle

CAUTION

If the mirror is jammed with ice, do not adjust the mirror by force. Use an approved spray de-icer (not radiator antifreeze) to release the frozen mechanism or move the vehicle to a warm place and allow the ice to melt.

WARNING

Do not adjust or fold the outside rearview mirrors whilst the vehicle is moving. This could result in loss of control, and an accident which could cause death, serious injury or property damage.

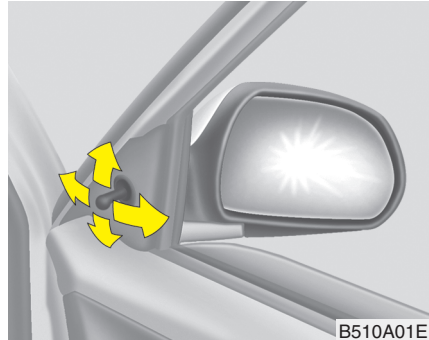

B510A01ER

D140201AFD-UK

Remote control

Manual type

The outside rearview mirrors are equipped with a remote control for your convenience. It is operated by the control lever in the bottom front corner of the window.

Before driving away, always check that your mirrors are positioned so you can see behind you, both to the left and right sides, as well as directly behind your vehicle. When using the mirror, always exercise caution when attempting to judge the distance of vehicles behind or along side of you.



OFD047032R

Electric type (if equipped)

The electric remote control mirror switch allows you to adjust the position of the left and right outside rearview mirrors. To adjust the position of either mirror, move the lever (1) to R or L to select the right side mirror or the left side mirror, then press a corresponding point on the mirror adjustment control to position the selected mirror up, down, left or right.

After adjustment, put the lever into neutral position to prevent the inadvertent adjustment.

⚠ CAUTION

- *The mirrors stop moving when they reach the maximum adjusting angles, but the motor continues to operate whilst the switch is depressed. Do not depress the switch longer than necessary, the motor may be damaged.*
- *Do not attempt to adjust the outside rearview mirror by hand. Doing so may damage the parts.*

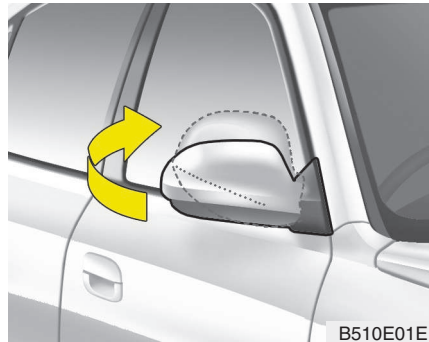

D140202AFD

Folding the outside rearview mirror

Manual type

To fold outside rearview mirror, grasp the housing of mirror and then fold it toward the rear of the vehicle.



Electric type (if equipped)

To fold the outside rearview mirror, depress the button.

To unfold it, depress the button again.

⚠ CAUTION

In case of the electric type of outside rearview mirror, don't fold it by hand. It could cause the failure of the motor.

Features of your vehicle

INSTRUMENT CLUSTER

Type A



1. Tachometer
2. Engine temperature gauge
3. Fuel gauge
4. Speedometer
5. Turn signal indicators
6. Warning and indicator lights (if equipped)
7. Odometer/Trip computer (if equipped)

Type B



* The actual cluster in the vehicle may differ from the illustration.
For more details refer to the "Gauges" in the next pages.

D150000AFD

OFD040034LE/OFD040034E

Features of your vehicle

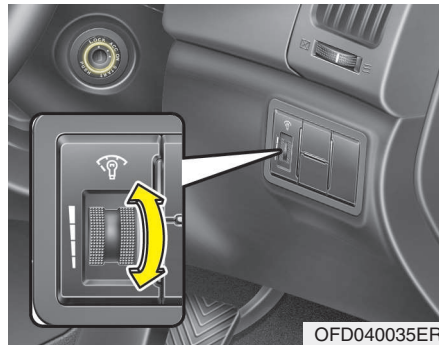

OFD040035ER

D150100AFD

Instrument panel illumination (if equipped)

When the vehicle's parking lights or headlights are on, rotate the illumination control knob to adjust the instrument panel illumination intensity.

The instrument cluster illumination intensity can be adjusted by rotating the control knob with the headlight switch in any position when the ignition switch is in ON position.

Type A



OFD047037

Type B



OFD040037E

Gauges

D150201AUN-UK

Speedometer

The speedometer indicates the forward speed of the vehicle.

The speedometer is calibrated in miles per hour and kilometers per hour.

Type A
Petrol



Diesel

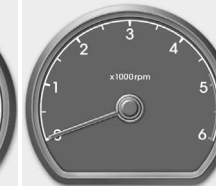

OFD047039/OFD047040

Type B
Petrol



Diesel



OFD040039E/OFD040040E

D150202AFD

Tachometer

The tachometer indicates the approximate number of engine revolutions per minute (rpm).

Use the tachometer to select the correct shift points and to prevent lugging and/or over-revving the engine.

Features of your vehicle

The tachometer pointer may move slightly when the ignition switch is in ACC or ON position with the engine OFF. This movement is normal and will not affect the accuracy of the tachometer once the engine is running.

CAUTION

Do not operate the engine within the tachometer's RED ZONE. This may cause severe engine damage.

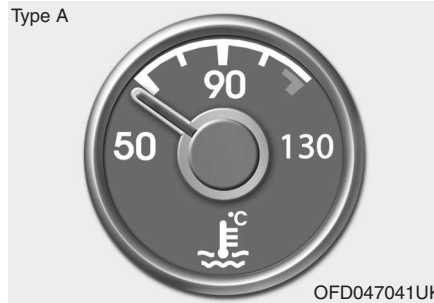

CAUTION

If the gauge pointer moves beyond the normal range area toward the "130°C" position, it indicates overheating that may damage the engine.



WARNING

Never remove the radiator cap when the engine is hot. The engine coolant is under pressure and could cause severe burns. Wait until the engine is cool before adding coolant to the reservoir.

D150203AFD-UK

Engine temperature gauge

This gauge shows the temperature of the engine coolant when the ignition switch is ON.

Do not continue driving with an overheated engine. If your vehicle overheats, refer to "If the engine overheats" in section 6.

Features of your vehicle

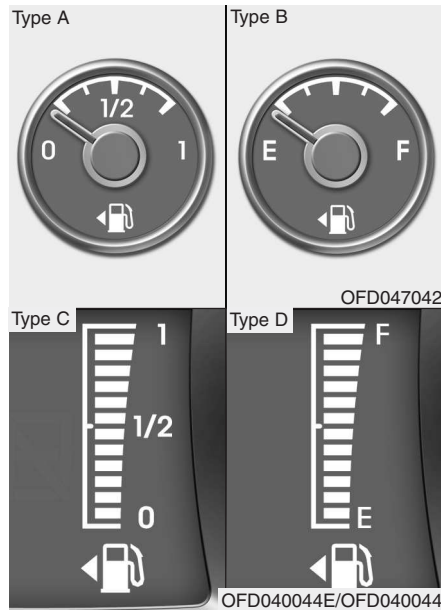

D150204AFD

Fuel gauge

The fuel gauge indicates the approximate amount of fuel remaining in the fuel tank. The fuel tank capacity is given in section 9. The fuel gauge is supplemented by a low fuel warning light, which will illuminate when the fuel tank is nearly empty.

On inclines or curves, the fuel gauge pointer may fluctuate or the low fuel warning light may come on earlier than usual due to the movement of fuel in the tank.

⚠ WARNING - Fuel gauge
 Running out of fuel can expose vehicle occupants to danger. You must stop and obtain additional fuel as soon as possible after the warning light comes on or when the gauge indicator comes close to the "0/E" level.

⚠ CAUTION
 Avoid driving with a very low fuel level. If you run out of fuel, it could cause the engine to misfire and result in excessive loading of the catalytic converter.

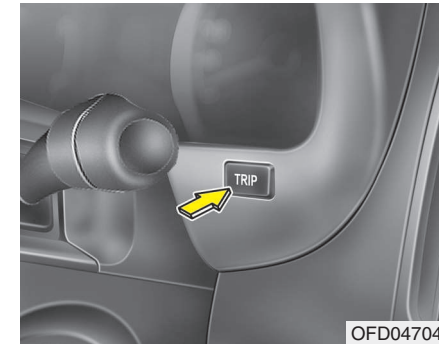

D150206AFD-UK

Odometer · Tripmeter/ Trip computer (if equipped)

The trip computer is a microcomputer-controlled driver information system that displays information related to driving, such as odometer, tripmeter, distance to empty, average speed, driving time, average fuel consumption and instant fuel consumption on the display when the ignition switch is in the ON position. All stored driving information (except odometer, distance to empty and instant fuel consumption) is reset if the battery is disconnected.

Features of your vehicle

The odometer is always displayed until the display is turned off. Press the TRIP button for less than 1 second to select any mode as follows:

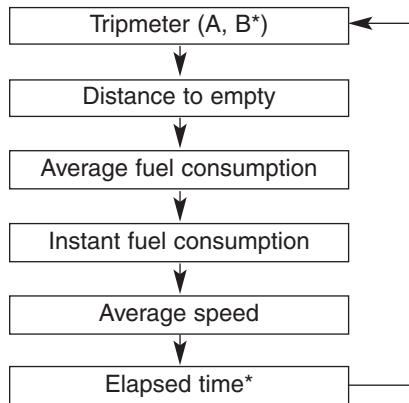

* if equipped

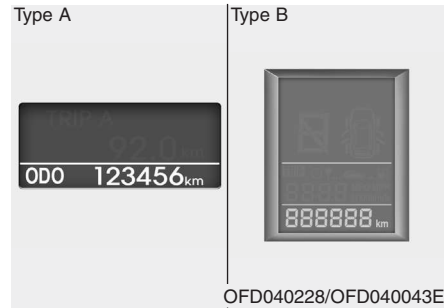

D150205AFD-UK

Odometer (km or MI)

The odometer indicates the total distance the vehicle has been driven.

You will also find the odometer useful to determine when periodic maintenance should be performed.

* NOTICE

It is forbidden that alteration of the odometer of any vehicle with the intent to change the mileage registered on the odometer. The alteration may void your warranty coverage.

Features of your vehicle

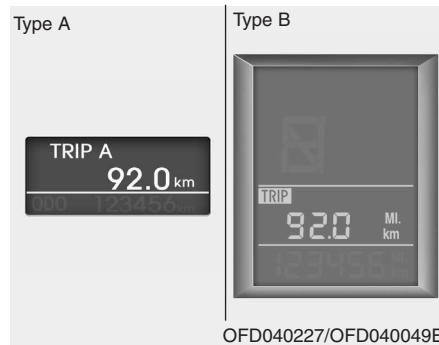

Tripmeter (km or miles)

This mode indicates the distance of individual trip since the last tripmeter reset. The meter's working range is from 0.0 to 999.9 miles (km).

Pressing the TRIP button for more than 1 second when the tripmeter is being displayed clears the tripmeter to zero (0.0).

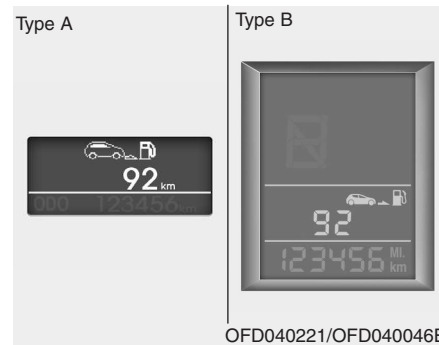

Distance to empty (km or miles)

This mode indicates the estimated distance to empty based on the current fuel in the fuel tank and the amount of fuel delivered to the engine. When the remaining distance is below 30 miles (50 km), "---" will be displayed and the distance to empty indicator will blink.

The meter's working range is from 30 to 999 miles (50 to 999 km).

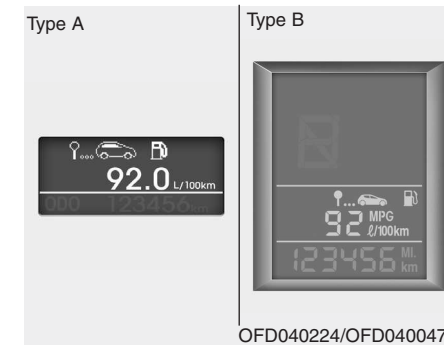

Average fuel consumption (l/100km or MPG)

This mode calculates the average fuel consumption from the total fuel used and the distance since the last average consumption reset. The total fuel used is calculated from the fuel consumption input. For an accurate calculation, drive more than 0.03 mile (50 m).

The meter's working range is from 0.1 to 99.9 l/100 km (0.1 to 99.9 miles per gallon).

Pressing the TRIP button for more than 1 second, when the average fuel consumption is being displayed, clears the average fuel consumption to zero (---).

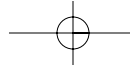

Features of your vehicle

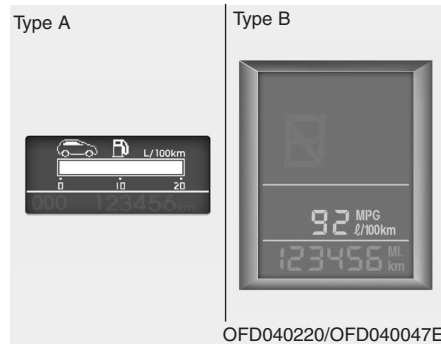

Instant fuel consumption (l/100 km or MPG)

This mode calculates the instant fuel consumption during the last few seconds.

* NOTICE

- If the vehicle is not on level ground or the battery power has been interrupted, the “Distance to empty” function may not operate correctly. The trip computer may not register additional fuel if less than 6 litres (1.6 gallons) of fuel are added to the vehicle.
- The fuel consumption and distance to empty values may vary significantly based on driving conditions, driving habits, and condition of the vehicle.
- The distance to empty value is an estimate of the available driving distance. This value may differ from the actual driving distance available.

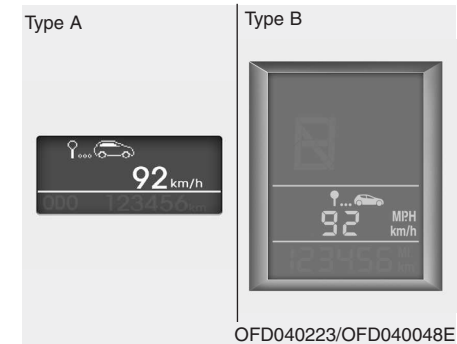

Average speed (km/h or MPH)

This mode calculates the average speed of the vehicle since the last average speed reset.

Even if the vehicle is not in motion, the average speed keeps going whilst the engine is running.

The meter's working range is from 0 to 999 mph (0 to 999 km/h).

Pressing the TRIP button for more than 1 second, when the average speed is being displayed, clears the average speed to zero (---).

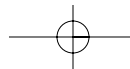

Features of your vehicle



Elapsed time (if equipped)

This mode indicates the total time traveled since the last driving time reset.

Even if the vehicle is not in motion, the driving time keeps going whilst the engine is running.

The meter's working range is from 00:00~99:59.

Pressing the TRIP button for more than 1 second, when the driving time is being displayed, clears the driving time to zero (00:00).

D150300AFD-UK

Warnings and indicators

All warning lights are checked by turning the ignition switch ON (do not start the engine). Any light that does not illuminate should be checked by a HYUNDAI authorised repairer.

After starting the engine, check to make sure that all warning lights are off. If any are still on, this indicates a situation that needs attention. When releasing the parking brake, the brake system warning light should go off. The fuel warning light will stay on if the fuel level is low.

D150302AFD-UK

Air bag warning light (if equipped)



This warning light will illuminate for approximately 6 seconds each time you turn the ignition switch to the ON position.

This light also comes on when the SRS is not working properly. If the AIRBAG warning light does not come on, or continuously remains on after operating for about 6 seconds when you turned the ignition switch to the ON position or started the engine, or if it comes on whilst driving, have the SRS inspected by a HYUNDAI authorised repairer.

Features of your vehicle

D150335AFD-UK

Passenger's front air bag OFF indicator (if equipped)



The passenger's front air bag OFF indicator illuminates for about 4 seconds after the ignition switch is turned to the ON position.

The passenger's front air bag OFF indicator also comes on when the passenger's front air bag ON/OFF switch is set to OFF position and turns off when the passenger's front air bag ON/OFF switch is set to ON position.

CAUTION

If there is a malfunction of the passenger's front air bag ON/OFF switch, the passenger's front air bag OFF indicator will not illuminate and the passenger's front air bag will inflate in frontal impact crashes even if the passenger's front air bag ON/OFF switch is set to OFF position.

If this occurs, have a HYUNDAI authorised repairer inspect the passenger's front air bag ON/OFF switch and the SRS air bag system as soon as possible.

D150303AFD-UK

Anti-lock brake system (ABS) warning light (if equipped)



This light illuminates if the ignition switch is turned to ON and goes off in approximately 3 seconds if the system is operating normally.

If the ABS warning light remains on, comes on whilst driving, or does not come on when the ignition switch is turned to the ON position, this indicates that there may be a problem with the ABS.

If this occurs, have your vehicle checked by a HYUNDAI authorised repairer as soon as possible. The normal braking system will still be operational, but without the assistance of the anti-lock brake system.

Electronic brake force distribution (EBD) system warning light



If two warning lights illuminate at the same time whilst driving, your vehicle may have a malfunction with ABS and EBD system.

In this case, your ABS and regular brake system may not work normally. Have the vehicle checked by a HYUNDAI authorised repairer as soon as possible.



WARNING

If the both ABS and Brake warning lights are on and stay on, your vehicle's brake system will not work normally. So you may experience an unexpected and dangerous situation during sudden braking. In this case, avoid high speed driving and abrupt braking. Have your vehicle checked by a HYUNDAI authorised repairer as soon as possible.

Features of your vehicle

D150304AFD-UK
Seat belt warning



Type A

As a reminder to the driver, the seat belt warning light will blink for approximately 6 seconds each time you turn the ignition switch ON regardless of belt fastening.

If the driver's seat belt is unfastened after the ignition switch is ON, the seat belt warning light blinks again for approximately 6 seconds. (if equipped)

If the driver's seat belt is not fastened when the ignition switch is turned ON or if it is unfastened after the ignition switch is ON, the seat belt warning chime will sound for approximately 6 seconds. At this time, if the seat belt is fastened, the chime will stop at once. (if equipped)

Type B

As a reminder to the driver and front passenger, the driver's and front passenger's seat belt warning lights will illuminate for approximately 6 seconds each time you turn the ignition switch ON regardless of belt fastening.

If the driver's or front passenger's seat belt is not fastened when the ignition switch is turned ON or if it is disconnected after the ignition switch is turned ON, the corresponding seat belt warning light will illuminate or blink until the belt is fastened.

If the driver's or front passenger's seat belt is not fastened when the ignition switch is turned ON and you drive over 12 mph (20 km/h), the seat belt warning chime will sound for approximately 100 seconds.

If the driver's or front passenger's seat belt is disconnected after the ignition switch is turned ON and you drive over 12 mph (20 km/h), the seat belt warning chime will sound for approximately 100 seconds.

After 100 seconds, if the seat belt is connected and disconnected again, the seat belt warning chime will sound again.

D150305AFD-UK
Turn signal indicator

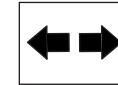

The blinking green arrows on the instrument panel show the direction indicated by the turn signals. If the arrow comes on but does not blink, blinks more rapidly than normal, or does not illuminate at all, a malfunction in the turn signal system is indicated. Your HYUNDAI authorised repairer should be consulted for repairs. This indicator also blinks when the hazard warning switch is turned on.

D150306AUN
High beam indicator



This indicator illuminates when the headlights are on and in the high beam position or when the turn signal lever is pulled into the Flash-to-Pass position.

Low beam indicator



This indicator light illuminates when the headlights are on.

Features of your vehicle

D150309AUN

**Front fog light indicator
(if equipped)**



This light comes on when the front fog lights are ON.

D150310AFD

**Rear fog light Indicator
(If equipped)**



This light comes on when the rear fog lights are ON.

**Tail light indicator
(if equipped)**

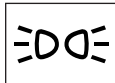

This indicator illuminates when the tail lights are on.

D150307AFD-UK

Engine oil pressure warning



This warning light indicates the engine oil pressure is low.

If the warning light illuminates whilst driving:

1. Drive safely to the side of the road and stop.
2. With the engine off, check the engine oil level. If the level is low, add oil as required.

If the warning light remains on after adding oil or if oil is not available, call a HYUNDAI authorised repairer.

CAUTION

If the engine is not stopped immediately after the engine oil pressure warning light is illuminated, severe damage could result.

CAUTION

If the oil pressure warning light stays on whilst the engine is running, serious engine damage may result. The oil pressure warning light comes on whenever there is insufficient oil pressure. In normal operation, it should come on when the ignition switch is turned on, then go out when the engine is started. If the oil pressure warning light stays on whilst the engine is running, there is a serious malfunction.

If this happens, stop the car as soon as it is safe to do so, turn off the engine and check the oil level. If the oil level is low, fill the engine oil to the proper level and start the engine again. If the light stays on with the engine running, turn the engine off immediately. In any instance where the oil light stays on when the engine is running, the engine should be checked by a HYUNDAI authorised repairer before the car is driven again.

D150350AFD-UK

Engine oil level warning light (1.6L Diesel engine, if equipped)



The engine oil level warning light illuminates when the engine oil level should be checked.

If the warning light comes on, check the engine oil level as soon as possible and add engine oil as required.

Slowly pour the recommended oil little by little into a funnel. (Oil refill capacity : approximately 0.6 ~ 1.0 l)

Use only the specified engine oil. (Refer to "Recommended lubricants and capacities" in section 9.)

Do not overfill the engine oil to ensure the oil level is not above F mark on the dipstick.

*** NOTICE**

- If you travel approximately 31 miles (50 km) after adding the engine oil, the warning light will go off.
- Cycle the ignition from OFF to ON 3 times within 10 seconds, the warning light will go off immediately. However, when you turn off the warning light without adding the engine oil, the light will come on again after traveling approximately 31 miles (50 km).

CAUTION

If the light comes on continuously after adding the engine oil and traveling approximately 31 miles (50 km), take your vehicle to your nearest HYUNDAI authorised repairer and have the system checked.

Even if this light doesn't come on after the engine has started, the engine oil should be checked and supplied periodically.



Engine coolant temperature warning light (if equipped)

The warning light shows the temperature of the engine coolant when the ignition switch is ON.

The warning light illuminates if the temperature of the engine coolant is above 120°C (248°F) and the warning light turns off if the temperature of the engine coolant is below 115°C (239°F).

Do not continue driving with an overheated engine. If your vehicle overheats, refer to "Overheating" in section 6.

*** NOTICE**

If the engine coolant temperature warning light illuminates, it indicates overheating that may damage the engine.

Features of your vehicle

D150308AFD-UK

Parking brake & brake fluid warning



Parking brake warning

This light is illuminated when the parking brake is applied with the ignition switch in the START or ON position. The warning light should go off when the parking brake is released.

Low brake fluid level warning

If the warning light remains on, it may indicate that the brake fluid level in the reservoir is low.

If the warning light remains on:

1. Drive carefully to the nearest safe location and stop your vehicle.
2. With the engine stopped, check the brake fluid level immediately and add fluid as required. Then check all brake components for fluid leaks.
3. Do not drive the vehicle if leaks are found, the warning light remains on or the brakes do not operate properly. Have it towed to a HYUNDAI authorised repairer for a brake system inspection and necessary repairs.

Your vehicle is equipped with dual-diagonal braking systems. This means you still have braking on two wheels even if one of the dual systems should fail. With only one of the dual systems working, more than normal pedal travel and greater pedal pressure are required to stop the car. Also, the car will not stop in as short a distance with only a portion of the brake system working. If the brakes fail whilst you are driving, shift to a lower gear for additional engine braking and stop the car as soon as it is safe to do so.

To check bulb operation, check whether the parking brake and brake fluid warning light illuminates when the ignition switch is in the ON position.

WARNING

Driving the vehicle with a warning light on is dangerous. If the brake warning light remains on, have the brakes checked and repaired immediately by a HYUNDAI authorised repairer.

D150331AFD-UK

Low tyre pressure telltale (if equipped)



Low tyre pressure position telltale (if equipped)



The low tyre pressure and position telltales come on for 3 seconds after the ignition switch is turned to the ON position.

If the warning lights do not come on, or continuously remain on after coming on for about 3 seconds when you turned the ignition switch to the ON position, the Tyre Pressure Monitoring System is not working properly. If this occurs, have your vehicle checked by a HYUNDAI authorised repairer as soon as possible.

This warning lights will also illuminate if one or more of your tyres is significantly under-inflated. The low tyre pressure position telltale will indicate which tyre is significantly under-inflated by illuminating the corresponding position light. You should stop and check your tyres as soon as possible. If the warning lights illuminate whilst driving, reduce vehicle speed immediately and stop the vehicle.

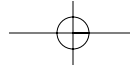

Features of your vehicle

Avoid hard braking and overcorrecting at the steering wheel. Inflate the tyres to the proper pressure as indicated on the vehicle's tyre information placard.

⚠ WARNING - Low tyre pressure
Significantly low tyre pressure makes the vehicle unstable and can contribute to loss of vehicle control and increased braking distances. Continued driving on low pressure tyres will cause the tyres to overheat and fail.

D150332AEN-UK
TPMS (Tyre Pressure Monitoring System) malfunction indicator (if equipped)

TPMS

The TPMS malfunction indicator comes on for 3 seconds after the ignition switch is turned to the ON position. If the warning light does not come on, or continuously remains on after coming on for about 3 seconds when you turned the ignition switch to the ON position, the Tyre Pressure Monitoring System is not working properly. If this occurs, have your vehicle checked by a HYUNDAI authorised repairer as soon as possible. The warning light also comes on and stays on when there is a problem with the Tyre Pressure Monitoring System. If this happens, the system may not monitor the tyre pressure. Have the system checked by a HYUNDAI authorised repairer as soon as possible.

⚠ WARNING - Safe stopping

- The TPMS cannot alert you to severe and sudden tyre damage caused by external factors.
- If you feel any vehicle instability, immediately take your foot off the accelerator, apply the brakes gradually and with light force, and slowly move to a safe position off the road.

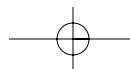
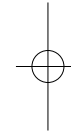
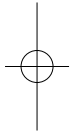

Features of your vehicle

D150312AUN

Shift pattern indicators (if equipped)

Automatic transaxle

The indicator displays to show the automatic transaxle shift lever selection.

Manual transaxle shift indicator (if equipped)

This indicator informs you which gear is desired whilst driving to save fuel.

For example

▲3: Indicates that shifting up to the 3rd gear is desired (currently the shift lever is in the 2nd or 1st gear).

▼3: Indicates that shifting down to the 3rd gear is desired (currently the shift lever is in the 4th or 5th gear).

When the system is not working properly, the indicator (Up & Down Arrow and gear) is not displayed.



D150313AFD-UK

Charging system warning

This warning light indicates a malfunction of either the generator or electrical charging system.

If the warning light comes on whilst the vehicle is in motion:

1. Drive to the nearest safe location.
2. With the engine off, check the generator drive belt for looseness or breakage.
3. If the belt is adjusted properly, a problem exists somewhere in the electrical charging system. Have a HYUNDAI authorised repairer correct the problem as soon as possible.



D150316AUN

Door ajar warning light

This warning light illuminates when a door is not closed securely with the ignition switch in any position.

Tailgate open warning light (if equipped)

This warning light illuminates when the tailgate is not closed securely with the ignition switch in any position.

Door open position indicator (including tailgate, if equipped)

This indicator illuminates when a door is not closed securely. The indicator displays which door is opened.



Features of your vehicle

D150317AFD-UK

Immobiliser indicator (if equipped)



This light illuminates when the immobiliser key is inserted and turned to the ON position to start the engine.

At this time, you can start the engine. The light goes out after the engine is running. If this light blinks when the ignition switch is in the ON position before starting the engine, have the system checked by a HYUNDAI authorised repairer.

D150318AFD

Low fuel level warning



This warning light indicates the fuel tank is nearly empty. When it comes on, you should add fuel as soon as possible. Driving with the fuel level warning light on or with the fuel level below "0/E" can cause the engine to misfire and damage the catalytic converter.

D150319AUN

Low washer fluid level warning indicator (if equipped)



This warning light indicates the washer fluid reservoir is near empty. Refill the washer fluid as soon as possible.

D150320AFD-UK

Malfunction indicator lamp (MIL) (check engine light)



This indicator light is part of the Engine Control System which monitors various emission control system components. If this light illuminates whilst driving, it indicates that a potential problem has been detected somewhere in the emission control system.

This light will also illuminate when the ignition switch is turned to the ON position, and will go out in a few seconds after the engine is started. If it illuminates whilst driving, or does not illuminate when the ignition key is turned to the ON position, take your vehicle to your nearest HYUNDAI authorised repairer and have the system checked.

Generally, your vehicle will continue to be drivable, but have the system checked by a HYUNDAI authorised repairer promptly.

CAUTION

- **Prolonged driving with the Emission Control System Malfunction Indicator Light illuminated may cause damage to the emission control systems which could effect drivability and/or fuel economy.**
- **If the Emission Control System Malfunction Indicator Light illuminates, potential catalytic converter damage is possible which could result in loss of engine power. Have the Engine Control System inspected as soon as possible by a HYUNDAI authorised repairer.**

CAUTION - Diesel engine (if equipped)

If the malfunction indicator light blinking, have the Particulate Filter System inspected by a HYUNDAI authorised repairer (before driving more than 31 miles/50 km).

Features of your vehicle

 **CAUTION - Diesel engine
(if equipped with DPF)**

When the malfunction indicator light is blinks, it may stop blinking after driving the vehicle at more than 60km/h (37 mph) or at more than second gear with 1500 ~ 2000 engine rpm for a certain time (for about 25 minutes).

If the malfunction indicator light continues to be blinked in spite of the procedure, please visit an authorised HYUNDAI dealer and then check the DPF system.

If you continue to drive with the malfunction indicator light blinking for a long time, the DPF system can be damaged and fuel consumption can be worsen.

D150340AFD

AUTO STOP
*AUTO STOP indicator
(if equipped)*

This indicator will illuminate when the engine enters the Idle Stop mode of the ISG (Idle Stop and Go) system.

When the automatic starting occurs, the "AUTO STOP" indicator on the cluster will blink for 5 seconds.

For more details, refer to section 5, "ISG (Idle Stop and Go) system".

*** NOTICE**

When the engine automatically starts by the ISG system, some warning lights (ABS, ESP, ESP OFF or Parking brake warning light) may turn on for a few seconds. This happens because of the low battery voltage. It does not mean the system is malfunctioning.

D150323AUN-EE

ESP
*ESP indicator (Electronic
Stability Program)
(if equipped)*

The ESP indicator will illuminate when the ignition switch is turned ON, but should go off after approximately 3 seconds. When the ESP is on, it monitors the driving conditions and under normal driving conditions, the ESP light will remain off. When a slippery or low traction condition is encountered, the ESP will operate, and the ESP indicator will blink to indicate the ESP is operating.

Features of your vehicle

D150324AFD-UK
ESP OFF indicator
(if equipped)

**ESP
OFF**

The ESP OFF indicator will illuminate when the ignition switch is turned ON, but should go off after approximately 3 seconds. To switch to ESP OFF mode, press the ESP OFF button. The ESP OFF indicator will illuminate indicating the ESP is deactivated. If this indicator stays on when ESP OFF is not selected, the ESP may have a malfunction. Take your car to a HYUNDAI authorised repairer and have the system checked.

* NOTICE

After reconnecting or recharging a discharged battery, the ESP OFF indicator may illuminate. In this case, turn the steering wheel 360 degrees to the left and 360 degrees to the right whilst the ignition switch is in the ON position. Then, restart the engine after the ignition is off. If the ESP OFF indicator does not turn off, have the system checked by a HYUNDAI authorised repairer as soon as possible.

D150325AFD
Cruise indicator
(if equipped)
CRUISE indicator



The indicator light illuminates when the cruise control system is enabled. The cruise indicator light in the instrument cluster is illuminated when the cruise control ON/OFF button on the steering wheel is pushed. The indicator light turns off when the cruise control ON/OFF button is pushed again. For more Information about the use of cruise control, refer to section 5, "Cruise control system".

Cruise SET indicator

SET

The indicator light illuminates when the cruise function switch (+RES/SET-) is ON. The cruise SET indicator light in the instrument cluster is illuminated when the cruise control switch (+RES/SET-) is pushed. The cruise SET indicator light does not illuminate when the cruise control switch O (CANCEL) is pushed or the system is disengaged.

Features of your vehicle

Speed limit indicator (if equipped)



(1) Speed limit indicator

(2) Set speed limit indicator

The speed limit indicator illuminates when the speed limit control system is enabled.

The speed limit indicator in the instrument cluster illuminates when the speed limit ON-OFF button on the steering wheel is pressed.

If the "--- (OFF)" indicator is shown in the instrument cluster, it indicates no setting of the speed limit.

The set speed limit will display when the speed limit control switch (+RES/SET-) is ON.

If you drive over the speed limit, the set speed limit will blink and chime will sound.

The set speed limit turns off when the speed limit is cancelled by pressing the O (CANCEL) button.

The speed limit indicator goes off when the speed limit is deactivated.

For more information about the speed limit control usage, refer to "Speed Limit control System" in section 5.

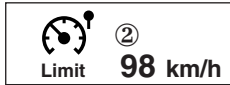

D150327AUN-UK

Key reminder warning chime (if equipped)

If the driver's door is opened whilst the ignition key is left in the ignition switch (ACC or LOCK position), the key reminder warning chime will sound. This is to prevent you from locking your keys in the vehicle. The chime sounds until the key is removed from the ignition switch or the driver's door is closed.

D150328AFD-UK

Glow indicator (Diesel engine)

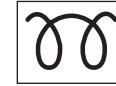

The indicator light illuminates when the ignition switch is placed at the ON position. The engine can be started after the preheat indicator light goes off. The illuminating time varies with the water temperature, air temperature and battery condition.

* NOTICE

If the engine was not started within 10 seconds after the preheating is completed, turn the ignition key once more to the LOCK position during 10 seconds, and then to the ON position, in order to preheat again.

⚠ CAUTION

If the preheat indicator light continues to illuminate or flash on and off after the engine has warmed up or whilst driving, check the system by a HYUNDAI authorised repairer as soon as possible.

Features of your vehicle

D150329AFD-UK

Fuel filter warning light (Diesel engine)



This warning light illuminates for 3 seconds after the ignition switch is set to the ON position and then it will go out. If it lights up whilst the engine is running, it indicates that water has accumulated inside the fuel filter. If this happens, remove the water from the fuel filter. For more information, refer to section 7, "Fuel filter".

CAUTION

When the fuel filter warning light is illuminated, engine power (vehicle speed & idle speed) may decrease. If you keep driving with the warning light on, you can damage your vehicle's engine parts and injection system of the Common Rail. If this occurs, have your vehicle checked by a HYUNDAI authorised repairer as soon as possible.

D150334AFD-UK

Electric power steering (EPS) system warning light

EPS

This indicator light comes on after the ignition key is turned to the ON position and then it will go out after the engine is started.

This light also comes on when the EPS has some troubles. If it comes on whilst driving, have your vehicle inspected by a HYUNDAI authorised repairer.

LCD display warnings and indicators (if equipped)

Door open

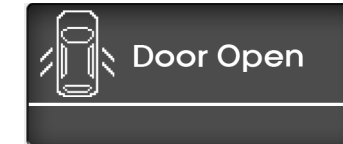

The monitor will display the corresponding door or tailgate that is not closed securely.

Low Tyre Pressure (if equipped)



The monitor will display the corresponding tyre that is low with pressure. For details, see Tyre Pressure Monitoring System on chapter 6.

* The actual indicator in LCD display may differ from the illustration.

Features of your vehicle

REAR PARKING ASSIST SYSTEM (IF EQUIPPED)

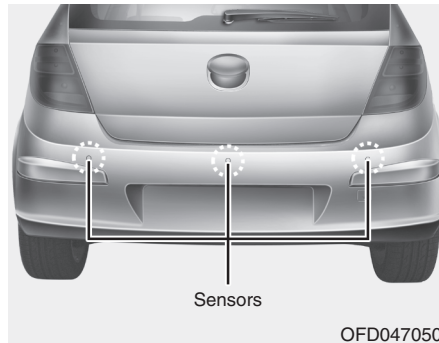

D170000AEN-UK

The rear parking assist system assists the driver during backward movement of the vehicle by chiming if any object is sensed within a distance of 47 in. (120 cm) behind the vehicle. This system is a supplemental system and it is not intended to nor does it replace the need for extreme care and attention of the driver. The sensing range and objects detectable by the rear parking assist sensors are limited. Whenever reversing, pay as much attention to what is behind you as you would in a vehicle without a rear parking assist system.

⚠ WARNING

The rear parking assist system is a supplementary function only. The operation of the rear parking assist system can be affected by several factors (including environmental conditions). It is the responsibility of the driver to always check the area behind the vehicle before and whilst reversing.

Operation of the rear parking assist system

D170101AEN-UK

Operating condition

- This system will activate when reversing with the ignition switch ON.
If the vehicle is moving at a speed over 3 mph (5 km/h), the system may not be activated correctly.
- The sensing distance whilst the rear parking assist system is in operation is approximately 47 in. (120 cm).
- When more than two objects are sensed at the same time, the closest one will be recognized first.

D170102AEN

Types of warning sound

- When an object is 47 in. to 32 in. (120 cm to 81 cm) from the rear bumper: Buzzer beeps intermittently.
- When an object is 31 in. to 16 in. (80 cm to 41 cm) from the rear bumper: Buzzer beeps more frequently.
- When an object is within 15 in. (40 cm) of the rear bumper: Buzzer sounds continuously.

D170200AEN

Non-operational conditions of rear parking assist system

The rear parking assist system may not operate properly when:

1. Moisture is frozen to the sensor. (It will operate normally when the moisture has been cleared.)
2. The sensor is covered with foreign matter, such as snow or water, or the sensor cover is blocked. (It will operate normally when the material is removed or the sensor is no longer blocked.)
3. Driving on uneven road surfaces (unpaved roads, gravel, bumps, gradient).
4. Objects generating excessive noise (vehicle horns, loud motorcycle engines, or truck air brakes) are within range of the sensor.
5. Heavy rain or water spray exists.
6. Wireless transmitters or mobile phones are within range of the sensor.
7. The sensor is covered with snow.
8. Trailer towing

The detecting range may decrease when:

1. The sensor is stained with foreign matter such as snow or water. (The sensing range will return to normal when removed.)
2. Outside air temperature is extremely hot or cold.

The following objects may not be recognized by the sensor:

1. Sharp or slim objects such as ropes, chains or small poles.
2. Objects which tend to absorb the sensor frequency such as clothes, spongy material or snow.
3. Undetectable objects smaller than 40 in. (1 m) in height and narrower than 6 in. (14 cm) in diameter.

D170300AEN-UK

Rear parking assist system precautions

- The rear parking assist system may not sound sequentially depending on the speed and shapes of the objects detected.
- The rear parking assist system may malfunction if the vehicle bumper height or sensor installation has been modified or damaged. Any non-factory installed equipment or accessories may also interfere with the sensor performance.
- The sensor may not recognize objects less than 15 in. (40 cm) from the sensor, or it may sense an incorrect distance. Use caution.
- When the sensor is frozen or stained with snow, dirt, or water, the sensor may be inoperative until the stains are removed using a soft cloth.
- Do not push, scratch or strike the sensor. Sensor damage could occur.

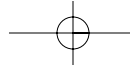

Features of your vehicle

* NOTICE

This system can only sense objects within the range and location of the sensors; It can not detect objects in other areas where sensors are not installed. Also, small or slim objects, such as poles or objects located between sensors may not be detected by the sensors.

Always visually check behind the vehicle when reversing.

Be sure to inform any drivers of the vehicle that may be unfamiliar with the system regarding the systems capabilities and limitations.

WARNING

Pay close attention when the vehicle is driven close to objects on the road, particularly pedestrians, and especially children. Be aware that some objects may not be detected by the sensors, due to the object's distance, size or material, all of which can limit the effectiveness of the sensor. Always perform a visual inspection to make sure the vehicle is clear of all obstructions before moving the vehicle in any direction.

D170400AFD-UK

Self-diagnosis

If you don't hear an audible warning sound or if the buzzer sounds intermittently when shifting the gear to the R (Reverse) position, this may indicate a malfunction in the rear parking assist system. If this occurs, have your vehicle checked by a HYUNDAI authorised repairer as soon as possible.

WARNING

Your new vehicle warranty does not cover any accidents or damage to the vehicle or injuries to its occupants due to a rear parking assist system malfunction. Always drive safely and cautiously.

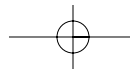
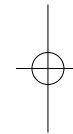
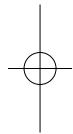

HAZARD WARNING FLASHER



D180000AUN

The hazard warning flasher should be used whenever you find it necessary to stop the car in a hazardous location. When you must make such an emergency stop, always pull off the road as far as possible.

The hazard warning lights are turned on by pushing in the hazard switch. This causes all turn signal lights to blink. The hazard warning lights will operate even though the key is not in the ignition switch.

To turn the hazard warning lights off, push the switch a second time.

Features of your vehicle

LIGHTING

D190100AUN

Battery saver function

- The purpose of this feature is to prevent the battery from being discharged. The system automatically turns off the parking lights when the driver removes the ignition key and opens the driver- side door.
- With this feature, the parking lights will be turned off automatically if the driver parks on the side of road at night. If necessary, to keep the lights on when the ignition key is removed, perform the following :
 - 1) Open the driver-side door.
 - 2) Turn the parking lights OFF and ON again using the light switch on the steering column.

Headlight escort function (if equipped)

If you turn the ignition switch to the ACC or LOCK position with the headlights ON, the headlights remain on for about 20 minutes. However, if the driver's door is opened and closed, the headlights are turned off after 30 seconds.

The headlights can be turned off by pressing the lock button on the transmitter twice or turning the light switch to the LOCK position.

For deactivation or activation of this feature, contact an authorised HYUNDAI dealer.

Headlight welcome function (if equipped)

If you press the door unlock button on the transmitter when the light switch is in the headlight or AUTO (in the dark outside) position and all doors (and tailgate) are closed, the headlight will come on for about 15 seconds. At this time, if you press the door lock or unlock button on the transmitter, the headlights will turn off immediately.

CAUTION

If the driver gets out of the vehicle through other doors (except driver's door), the battery saver function does not operate and the headlight escort function does not turn off automatically. Therefore, it causes the battery to be discharged. In this case, make sure to turn off the lamp before getting out of the vehicle.

Features of your vehicle

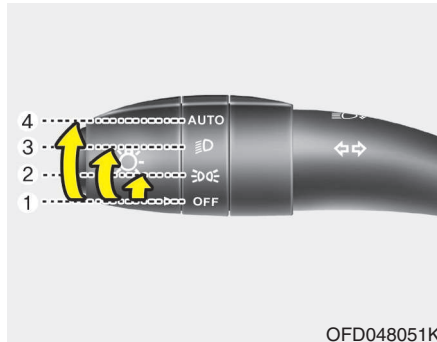

OFD048051K

D190400AUN

Lighting control

The light switch has a Headlight and a Parking light position.

To operate the lights, turn the knob at the end of the control lever to one of the following positions:

- (1) OFF position
- (2) Parking light position
- (3) Headlight position
- (4) Auto light position (if equipped)



OFD049052K

D190401AUN

Parking light position (1st position)

When the light switch is in the parking light position (1st position), the tail, position, license and instrument panel lights are ON.



OFD049053K

D190402AUN

Headlight position (2nd position)

When the light switch is in the headlight position (2nd position) the head, tail, position, license and instrument panel lights are ON.

* NOTICE

The ignition switch must be in the ON position to turn on the headlights.

Features of your vehicle

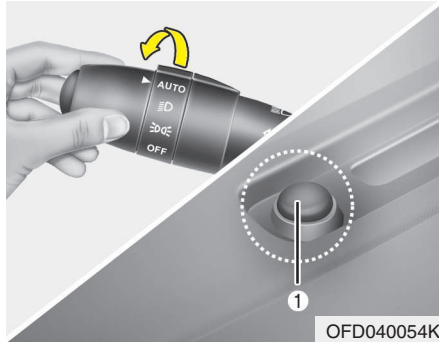

D190403AUN-UK

Auto light position (if equipped)

When the light switch is in the AUTO light position, the taillights and headlights will be turned ON or OFF automatically depending on the amount of light outside the vehicle.

CAUTION

- **Never place anything over sensor (1) located on the instrument panel, this will ensure better auto-light system control.**
- **Don't clean the sensor using a window cleaner, the cleaner may leave a light film which could interfere with sensor operation.**
- **If your vehicle has window tint or other types of metallic coating on the front windscreen, the Auto light system may not work properly.**

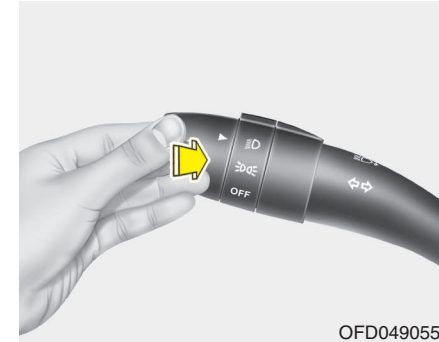

D190500AUN-UK

High - beam operation

To turn on the high beam headlights, push the lever away from you. Pull it back for low beams.

The high-beam indicator will light when the headlight high beams are switched on.

To prevent the battery from being discharged, do not leave the lights on for a prolonged time whilst the engine is not running.

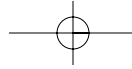

Features of your vehicle

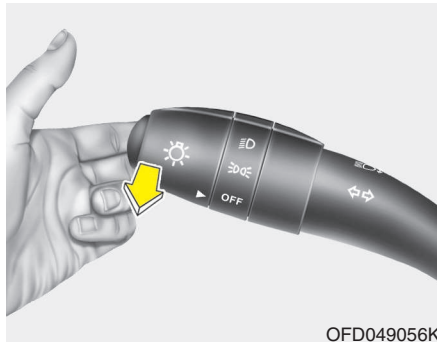

OFD049056K

Flashing headlights

To flash the headlights, pull the lever towards you. It will return to the normal (low-beam) position when released. The headlight switch does not need to be on to use this flashing feature.

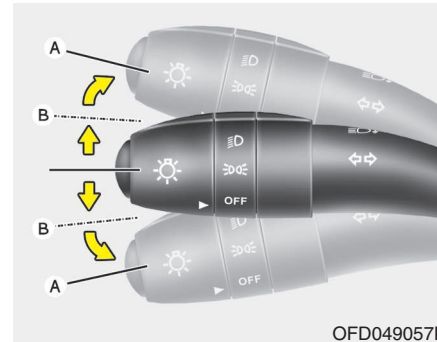

OFD049057K

D190600AUN

Turn signals and lane change signals

The ignition switch must be on for the turn signals to function. To turn on the turn signals, move the lever up or down (A).

Green arrow indicators on the instrument panel indicate which turn signal is operating. They will self-cancel after a turn is completed. If the indicator continues to flash after a turn, manually return the lever to the OFF position.

To signal a lane change, move the turn signal lever slightly and hold it in position (B). The lever will return to the OFF position when released.

If an indicator stays on and does not flash or if it flashes abnormally, one of the turn signal bulbs may be burned out and will require replacement.

*** NOTICE**

If an indicator flash is abnormally quick or slow, bulb may be burned out or have a poor electrical connection in the circuit.

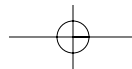
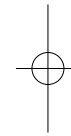
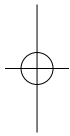

Features of your vehicle



D190700AFD

Front fog light (if equipped)

Fog lights are used to provide improved visibility and avoid accidents when visibility is poor due to fog, rain or snow etc. The fog lights will turn on when fog light switch (1) is turned to on position (2) after the parklight is turned on. To turn off the fog lights, turn the switch to on position again.

CAUTION

When in operation, the fog lights consume large amounts of vehicle electrical power. Only use the fog lights when visibility is poor.

OFD049058K



D190800AFD

Rear fog light (if equipped)

To turn the rear fog lights on, turn the headlight switch to the headlight on position and turn the rear fog light switch to the on position (3).

OFD049059

The rear fog lights turn on when the rear fog light switch is turned on after the front fog light switch is turned on and the headlight switch to the parklight position. To turn the rear fog lights off, turn the rear fog light switch to the on position again or turn the headlight switch off.

D190900AUN

Daytime running light (if equipped)

Daytime Running Lights (DRL) can make it easier for others to see the front of your vehicle during the day. DRL can be helpful in many different driving conditions, and it is especially helpful after dawn and before sunset.

The DRL system will make the headlights turn OFF when:

1. The parklight switch is ON.
2. Engine stops.

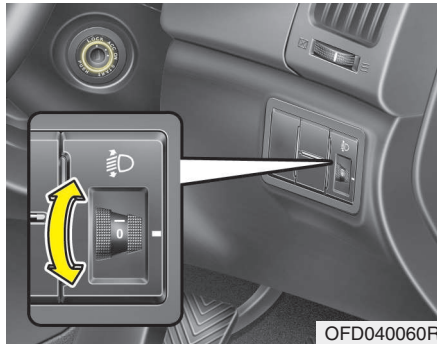

D191000AFD-UK

**Headlight levelling device
(if equipped)**

To adjust the headlight beam level according to the number of the passengers and the loading weight in the luggage area, turn the beam levelling switch.

The higher the number of the switch position, the lower the headlight beam level. Always keep the headlight beam at the proper levelling position, or headlights may dazzle other road users.

Listed below are the examples of proper switch settings. For loading conditions other than those listed below, adjust the switch position so that the beam level may be the nearest as the condition obtained according to the list.

Loading condition	Switch position
Driver only	0
Driver + front passenger	0
Full passengers (including driver)	1
Full passengers (including driver) + full boot loading (or light trailer loading)	2
Driver + full boot loading (or maximum trailer loading)	3

Features of your vehicle

WIPERS AND WASHERS

Windscreen wiper/washer

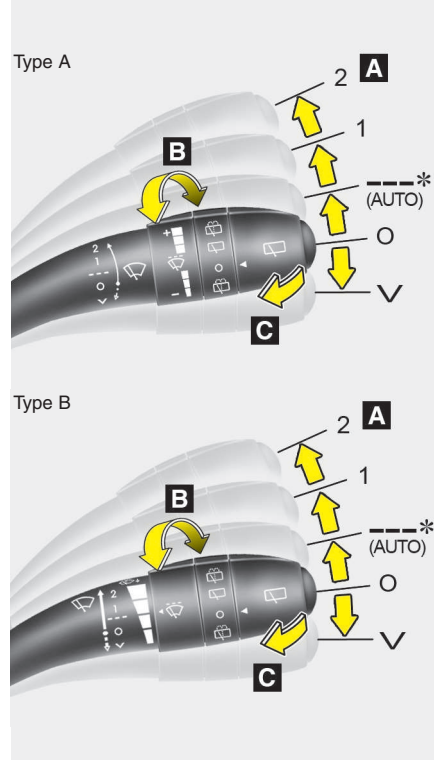

Rear window wiper/washer (if equipped)

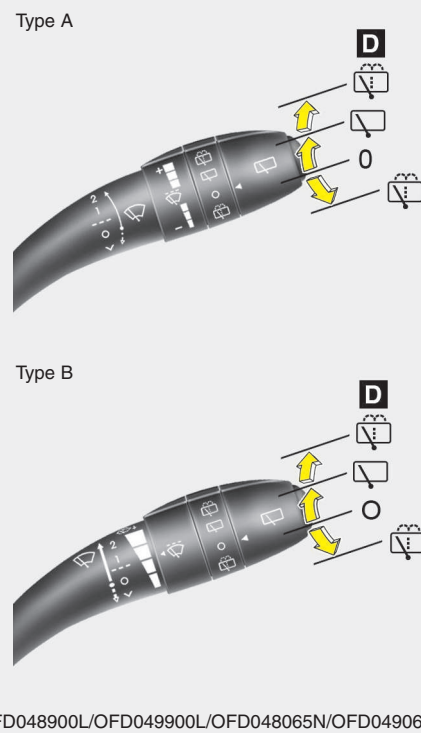

A : Wiper speed control

- ✓ – Single wipe
- O – Off
- --- / AUTO* – Intermittent wipe/
Auto control wipe
- 1 – Normal wiper speed
- 2 – Fast wiper speed

B : Intermittent or Auto control wipe time adjustment

C : Wash with brief wipes

D : Rear wiper/washer control

- [wiper icon with spray] – Spraying washer fluid
- [wiper icon] – Normal wipe operation
- O – Off
- [wiper icon with spray] – Wash with brief wipes

*: if equipped

OFD048900L/OFD049900L/OFD048065N/OFD049065N

Features of your vehicle

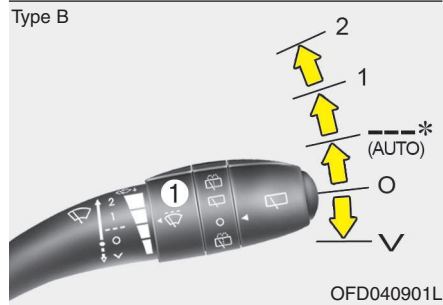
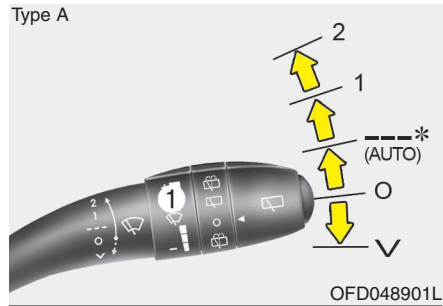

D200100AFD-UK

Windscreen wipers

Operates as follows when the ignition switch is turned ON.

✓ : For a single wiping cycle, push the lever downward and release it with the lever in the O position. The wipers will operate continuously if the lever is pushed downward and held.

O : Wiper is not in operation.

--- : Wiper operates intermittently at the same wiping intervals. Use this mode in a light rain or mist. To vary the speed setting, turn the speed control knob(1).

1 : Normal wiper speed

2 : Fast wiper speed

*** NOTICE**

If there is heavy accumulation of snow or ice on the windscreen, defrost the windscreen for about 10 minutes, or until the snow and/or ice is removed before using the windscreen wipers to ensure proper operation.

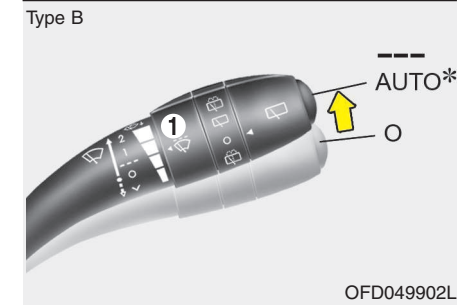
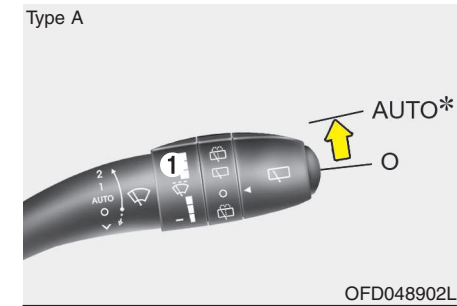

D200101AFD-UK

Auto control (if equipped)

The rain sensor located on the upper end of the windscreen glass senses the amount of rainfall and controls the wiping cycle for the proper interval. The more it rains, the faster the wiper operates. When the rain stops, the wiper stops.

Features of your vehicle

To vary the speed setting, turn the speed control knob (1).

If the ignition switch is turned ON when the wiper switch is set in AUTO mode, or the wiper switch is set in AUTO mode when the ignition switch is ON, or the speed control knob is turned upward when the wiper switch is in AUTO mode, the wiper will operate once to perform a self-check of the system. Set the wiper to O position when the wiper is not in use.

CAUTION

When the ignition switch is ON and the windscreen wiper switch is placed in the AUTO mode, use caution in the following situations to avoid any injury to the hands or other parts of the body:

- *Do not touch the upper end of the windscreen glass facing the rain sensor.*
- *Do not wipe the upper end of the windscreen glass with a damp or wet cloth.*
- *Do not put pressure on the windscreen glass.*

CAUTION

When washing the vehicle, set the wiper switch in the O position to stop the auto wiper operation.

The wiper may operate and be damaged if the switch is set in the AUTO mode whilst washing the vehicle.

Do not remove the sensor cover located on the upper end of the driver side windscreen glass. Damage to system parts could occur and may not be covered by your vehicle warranty.

When starting the vehicle in winter, set the wiper switch in the O position. Otherwise, wipers may operate and ice may damage the windscreen wiper blades. Always remove all snow and ice and defrost the windscreen properly prior to operating the windscreen wipers.

Type A

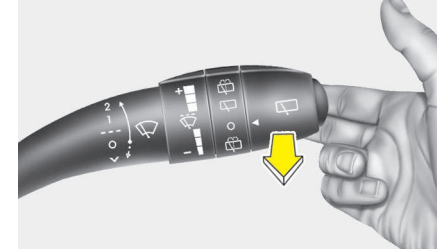

OFD048904L

Type B

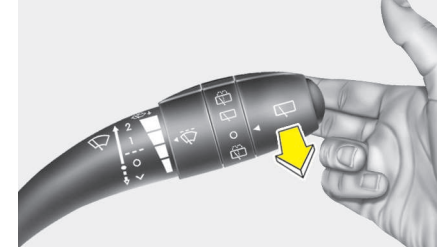

OFD049904L

D200200AFD-UK

Windscreen washers

In the O position, pull the lever gently toward you to spray washer fluid on the windscreen and to run the wipers 1-3 cycles.

Use this function when the windscreen is dirty.

Features of your vehicle

The spray and wiper operation will continue until you release the lever.

If the washer does not work, check the washer fluid level. If the fluid level is not sufficient, you will need to add appropriate non-abrasive windscreen washer fluid to the washer reservoir.

The reservoir filler neck is located in the front of the engine compartment on the driver side.

CAUTION

To prevent possible damage to the washer pump, do not operate the washer when the fluid reservoir is empty.

WARNING

Do not use the washer in freezing temperatures without first warming the windscreen with the defrosters; the washer solution could freeze on contact with the windscreen and obscure your vision.

CAUTION



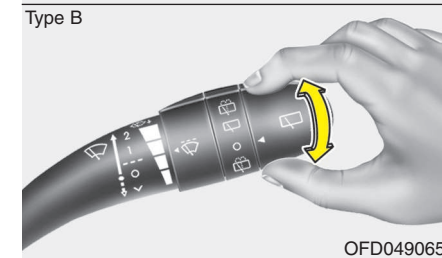
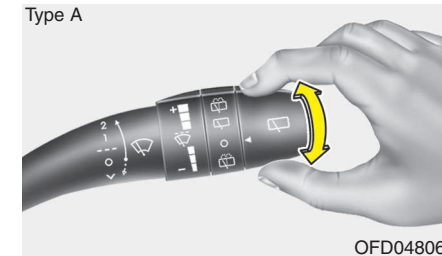

- *To prevent possible damage to the wipers or windscreen, do not operate the wipers when the windscreen is dry.*
- *To prevent damage to the wiper blades, do not use petrol, kerosene, paint thinner, or other solvents on or near them.*
- *To prevent damage to the wiper arms and other components, do not attempt to move the wipers manually.*



D200300AFD

Rear window wiper and washer switch (if equipped)

The rear window wiper and washer switch is located at the end of the wiper and washer switch lever. Turn the switch to desired position to operate the rear wiper and washer.

-  - Spraying washer fluid and wiping
-  - Normal wiper operation
-  - Wiper is not in operation
-  - Spraying washer fluid and wiping

Features of your vehicle

INTERIOR LIGHT

D210000AUN

CAUTION

Do not use the interior lights for extended periods when engine is not running. It may cause battery discharge.

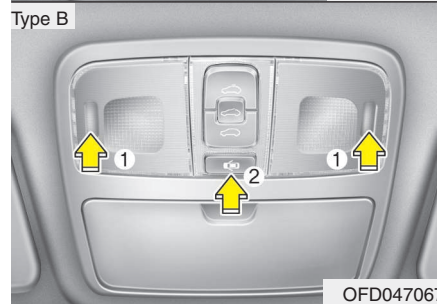
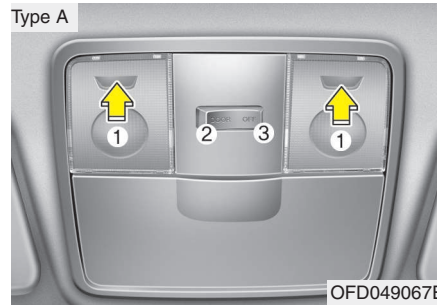

D210100AFD

Map lamp (if equipped)

Push in the map lamp lens (1) to turn the light on or off. This light produces a spot beam for convenient use as a map lamp at night or as a personal lamp for the driver and the passenger.

• DOOR (2) :

In the DOOR position, the light comes on when any door is opened regardless of the ignition switch position.

When doors are unlocked by the transmitter, the light comes on for approximately 30 seconds as long as any door is not open. The light goes out gradually after approximately 30 seconds if the door is closed. However, if the ignition switch is ON or all doors are locked, the light will turn off immediately.

If a door is opened with the ignition switch in the ACC or LOCK position, the light stays on for about 20 minutes. However, if a door is opened with the ignition switch in the ON position, the light stays on continuously.

• OFF (3) :

In the OFF position, the light stays off at all times even when a door is open.

Features of your vehicle



D210200AFD

Dome lamp

• ON (1):

In the ON position, the light stays on at all times.

⚠ CAUTION

Do not leave the switch in this position for an extended period of time when the vehicle is not running.

• DOOR (2) :

In the DOOR position, the light comes on when any door is opened regardless of the ignition switch position.

When doors are unlocked by the transmitter, the light comes on for approximately 30 seconds as long as any door is not open. The light goes out gradually after approximately 30 seconds if the door is closed. However, if the ignition switch is ON or all doors are locked, the light will turn off immediately.

If a door is opened with the ignition switch in the ACC or LOCK position, the light stays on for about 20 minutes. However, if a door is opened with the ignition switch in the ON position, the light stays on continuously.

• OFF (3) :

In the OFF position, the light stays off at all times even when a door is open.

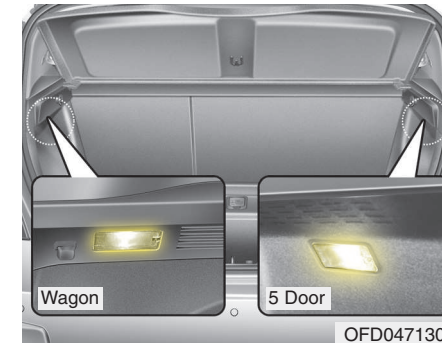

D210300AFD

Luggage room lamp

The luggage room lamp comes on when the tailgate is opened.

Features of your vehicle

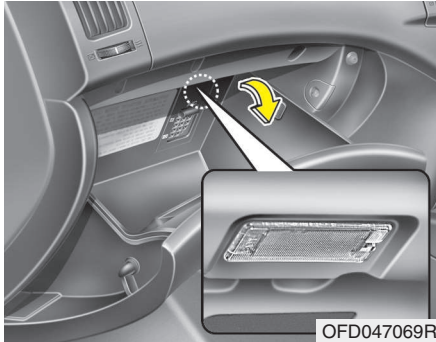

D210500AUN

Glove box lamp (if equipped)

The glove box lamp comes on when the glove box is opened.

The parking lights or headlights must be ON for the glove box lamp to function.

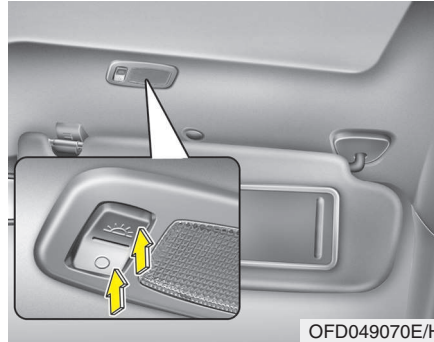

D210600ATD

Vanity mirror lamp (if equipped)

Push the switch to turn the light on or off.

- ☀ : The light turns on.
- ○ : The light turns off.

⚠ CAUTION - Vanity mirror lamp (if equipped)

Always have the switch in the off position when the vanity mirror lamp is not in use. If the sunvisor is closed without the lamp off, it may discharge the battery or damage the sunvisor.

DEFROSTER

D220000AUN-UK

⚠ CAUTION

To prevent damage to the conductors bonded to the inside surface of the rear window, never use sharp instruments or window cleaners containing abrasives to clean the window.

* NOTICE

If you want to defrost and defog on the front windscreen, refer to “Windscreen Defrosting and Defogging” in this section.

Features of your vehicle

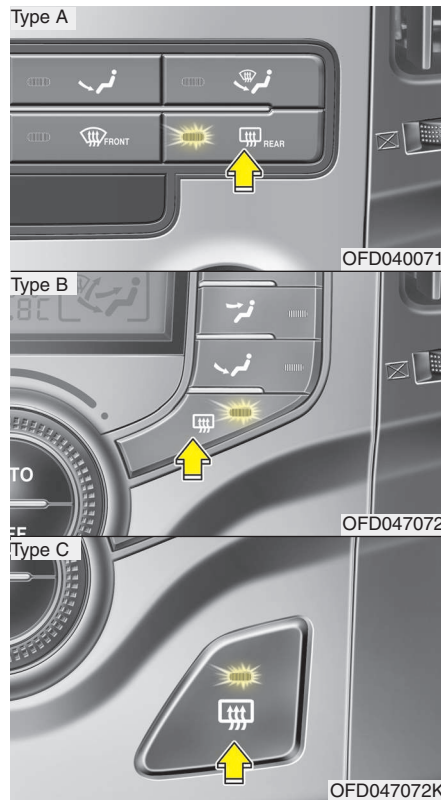

D220100AUN-UK

Rear window defroster

The defroster heats the window to remove frost, fog and thin ice from the interior and exterior of the rear window, whilst engine is running.

To activate the rear window defroster, press the rear window defroster button located in the centre facia switch panel. The indicator on the rear window defroster button illuminates when the defroster is ON.

If there is heavy accumulation of snow on the rear window, brush it off before operating the rear defroster.

The rear window defroster automatically turns off after approximately 20 minutes or when the ignition switch is turned off. To turn off the defroster, press the rear window defroster button again.

D220101AUN

Outside mirror defroster (if equipped)

If your vehicle is equipped with the outside mirror defrosters, they will operate at the same time you turn on the rear window defroster.

Front windscreen deicer (if equipped)

If your vehicle is equipped with front windscreen deicer, they will operate at the same time when you turn on the rear window defroster.

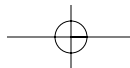

Features of your vehicle

MANUAL CLIMATE CONTROL SYSTEM (IF EQUIPPED)

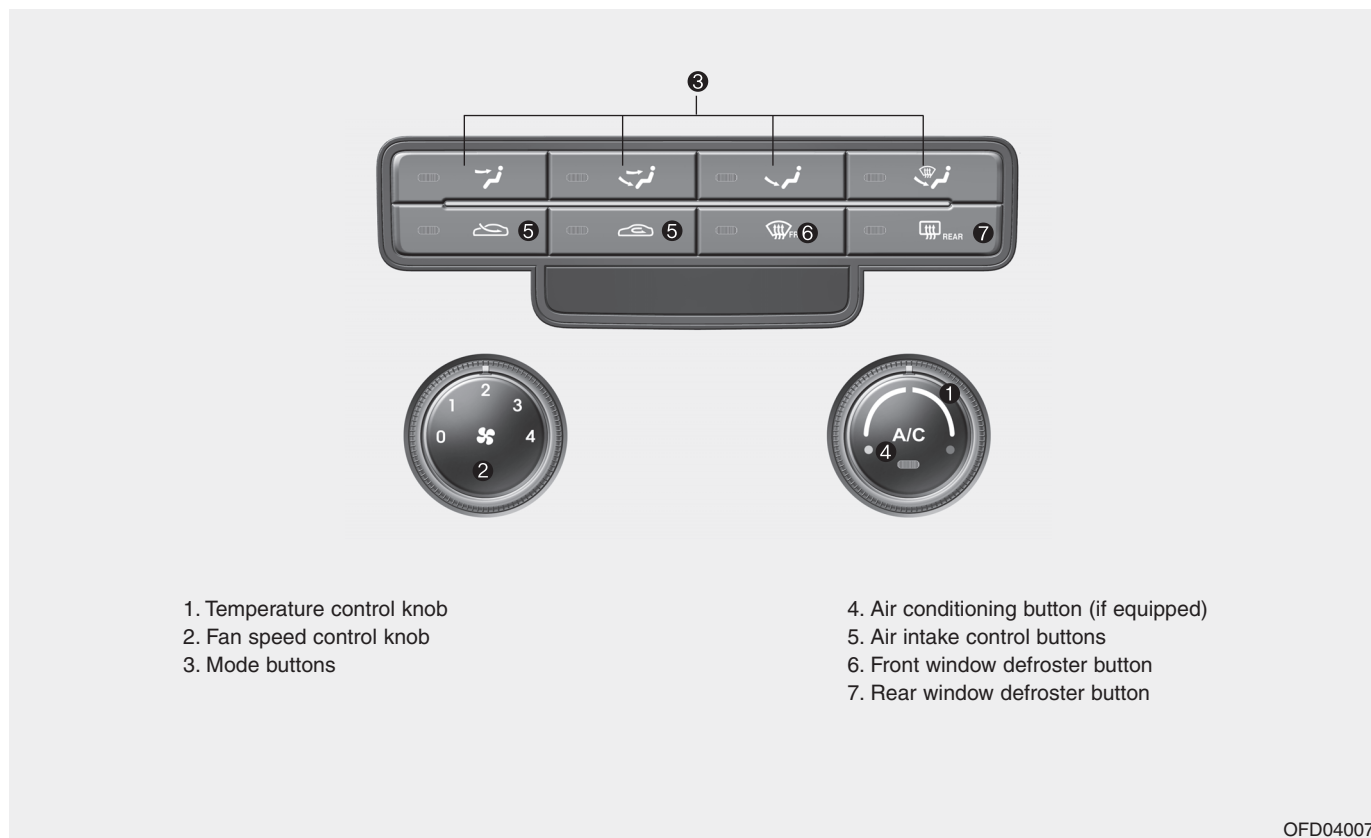

- 1. Temperature control knob
- 2. Fan speed control knob
- 3. Mode buttons

- 4. Air conditioning button (if equipped)
- 5. Air intake control buttons
- 6. Front window defroster button
- 7. Rear window defroster button

OFD040074

D230000AFD

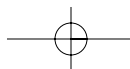

D230100AUN

Heating and air conditioning

1. Start the engine.
2. Set the mode to the desired position.
3. Set the temperature control to the desired position.
4. Set the air intake control to the outside (fresh) air position.
5. Set the fan speed control to the desired speed.
6. If air conditioning is desired, turn the air conditioning system (if equipped) on.

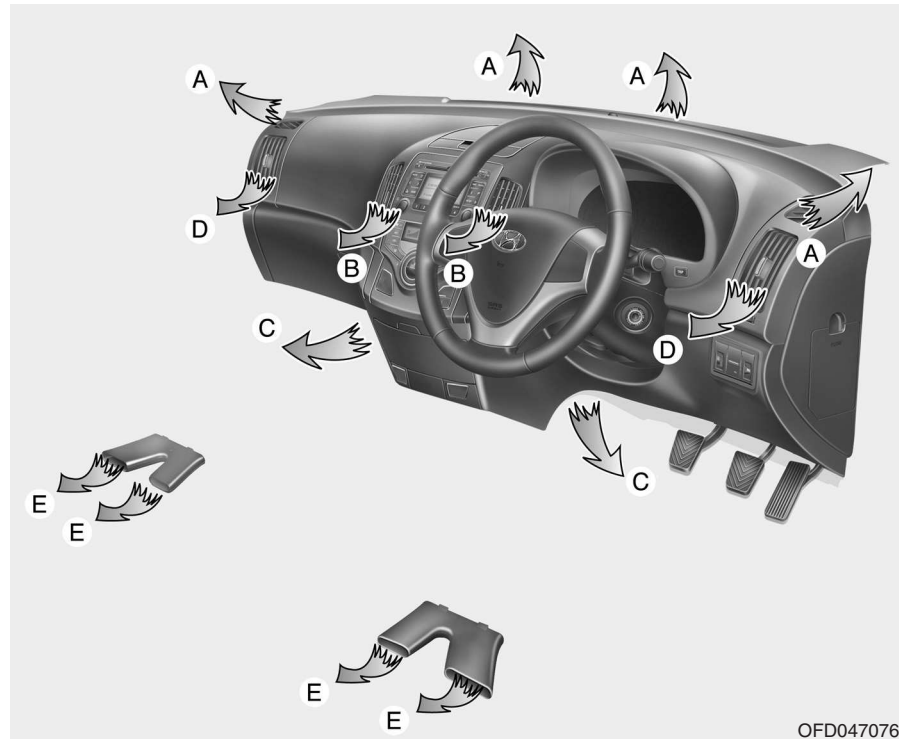

Features of your vehicle

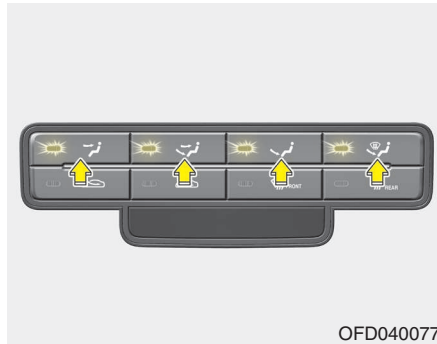

D230101AFD-UK

Mode selection

The mode buttons control the direction of the air flow through the ventilation system.

Air can be directed to the floor, dashboard outlets, or windscreen. Five symbols are used to represent Face, Bi-Level, Floor, Floor-Defrost and Defrost air position.

Face-Level (B,D)

Air flow is directed toward the upper body and face. Additionally, each outlet can be controlled to direct the air discharged from the outlet.

Bi-Level (B, D, C, E)

Air flow is discharged towards the face and floor.

Floor-Level (C, E, A, D)

Most of the air flow is directed to the floor, with a small amount of the air being directed to the windscreen and side window defroster.

Floor/Defrost-Level (A, C, E, D)

Most of the air flow is directed to the floor and the windscreen with a small amount directed to the side window defrosters.

Defrost-Level (A, D)

Most of the air flow is directed to the windscreen with a small amount of air directed to the side window defrosters.

Features of your vehicle

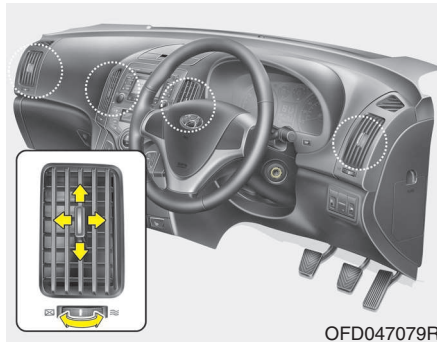

OFD047079R

Instrument panel vents

The outlet port can be opened or closed separately using the horizontal thumbwheel. To close the vent, rotate it left to the maximum position. To open the vent, rotate it right to the desired position.

Also, you can adjust the direction of air delivery from these vents using the vent control lever as shown.

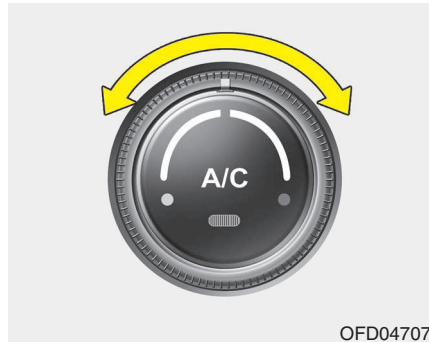

OFD047078

D230102AFD

Temperature control

The temperature control knob allows you to control the temperature of the air flowing from the ventilation system. To change the air temperature in the passenger compartment, turn the knob to the right position for warm air or left position for cooler air.

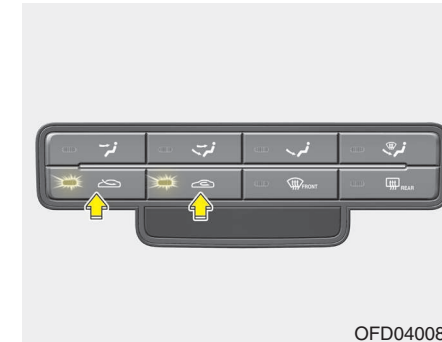

OFD040080

D230103AFD-UK

Air intake control

This is used to select outside (fresh) air position or recirculated air position.

To change the air intake control position, push the control button.

Features of your vehicle

Recirculated air position



The indicator light on the button is illuminated when the recirculated air position is selected.

With the recirculated air position selected, air from passenger compartment will be drawn through the heating system and heated or cooled according to the function selected.

Outside (fresh) air position



The indicator light on the button is illuminated when the outside (fresh) air position is selected.

With the outside (fresh) air position selected, air enters the vehicle from outside and is heated or cooled according to the function selected.

* NOTICE

Prolonged operation of the heater in the recirculated air position (without air conditioning selected) may cause fogging of the windscreen and side windows and the air within the passenger compartment may become stale. In addition, prolonged use of the air conditioning with the recirculated air position selected will result in excessively dry air in the passenger compartment.

⚠ WARNING

- Continued climate control system operation in the recirculated air position may allow humidity to increase inside the vehicle which may fog the glass and obscure visibility.
- Do not sleep in a vehicle with the air conditioning or heating system on. It may cause serious harm or death due to a drop in the oxygen level and/or body temperature.
- Continued climate control system operation in the recirculated air position can cause drowsiness or sleepiness, and loss of vehicle control. Set the air intake control to the outside (fresh) air position as much as possible whilst driving.



OFD047081

D230104AUN

Fan speed control

The ignition switch must be in the ON position for fan operation.

The fan speed control knob allows you to control the fan speed of the air flowing from the ventilation system. To change the fan speed, turn the knob to the right for higher speed or left for lower speed.

Setting the fan speed control knob to the "0" position turns off the fan.

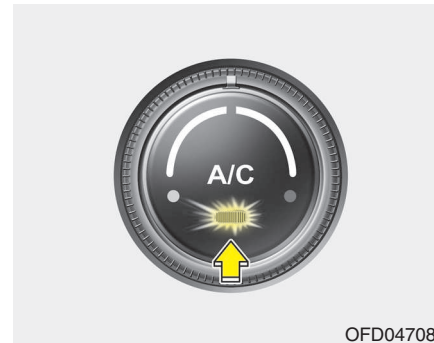

OFD047082

D230105AUN

Air conditioning (if equipped)

Push the A/C button to turn the air conditioning system on (indicator light will illuminate). Push the button again to turn the air conditioning system off.

System operation



D230501AUN

Ventilation

1. Set the mode to the  position.
2. Set the air intake control to the outside (fresh) air position.
3. Set the temperature control to the desired position.
4. Set the fan speed control to the desired speed.

D230502AUN-UK

Heating

1. Set the mode to the  position.
 2. Set the air intake control to the outside (fresh) air position.
 3. Set the temperature control to the desired position.
 4. Set the fan speed control to the desired speed.
 5. If dehumidified heating is desired, turn the air conditioning system (if equipped) on.
- If the windscreen fogs up, set the mode to the ,  position.

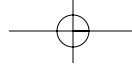

Features of your vehicle

Operation Tips

- To keep dust or unpleasant fumes from entering the car through the ventilation system, temporarily set the air intake control to the recirculated air position. Be sure to return the control to the fresh air position when the irritation has passed to keep fresh air in the vehicle. This will help keep the driver alert and comfortable.
- Air for the heating/cooling system is drawn in through the grilles just ahead of the windscreen. Care should be taken that these are not blocked by leaves, snow, ice or other obstructions.
- To prevent interior fog on the windscreen, set the air intake control to the fresh air position and fan speed to the desired position, turn on the air conditioning system, and adjust temperature control to desired temperature.

D230503AFD-UK

Air conditioning (if equipped)

All HYUNDAI Air Conditioning Systems are filled with environmentally friendly R-134a refrigerant which does not damage to the ozone layer.

1. Start the engine. Push the air conditioning button.
 2. Set the mode to the  position.
 3. Set the air intake control to the outside air or recirculated air position.
 4. Adjust the fan speed control and temperature control to maintain maximum comfort.
- When maximum cooling is desired, set the temperature control to the extreme left position then set the fan speed control to the highest speed.

*** NOTICE**

- When using the air conditioning system, monitor the temperature gauge closely whilst driving up hills or in heavy traffic when outside temperatures are high. Air conditioning system operation may cause engine overheating. Continue to use the blower fan but turn the air conditioning system off if the temperature gauge indicates engine overheating.
- When opening the windows in humid weather air conditioning may create water droplets inside the vehicle. Since excessive water droplets may cause damage to electrical equipment, air conditioning should only be run with the windows closed.

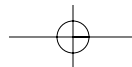
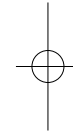
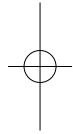

Air conditioning system operation tips

- If the vehicle has been parked in direct sunlight during hot weather, open the windows for a short time to let the hot air inside the vehicle escape.
- To help reduce moisture inside of windows on rainy or humid days, decrease the humidity inside the vehicle by operating the air conditioning system.
- During air conditioning system operation, you may occasionally notice a slight change in engine speed as the air conditioning compressor cycles. This is a normal system operation characteristic.
- Use the air conditioning system every month if only for a few minutes to ensure maximum system performance.
- When using the air conditioning system, you may notice clear water dripping (or even puddling) on the ground under the passenger side of the vehicle. This is a normal system operation characteristic.
- Operating the air conditioning system in the recirculated air position provides maximum cooling, however, continual operation in this mode may cause the air inside the vehicle to become stale.
- During cooling operation, you may occasionally notice a misty air flow because of rapid cooling and humid air intake. This is a normal system operation characteristics.

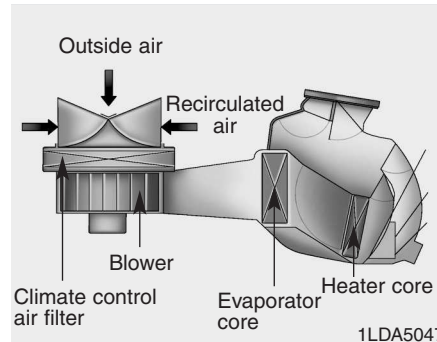

D230300AFD-UK

**Climate control air filter
(if equipped)**

The climate control air filter installed behind the glove box filters the dust and other pollutants that come into the vehicle from the outside through the heating and air conditioning system. If dust or other pollutants accumulate in the filter over a period of time, the air flow from the air vents may decrease, resulting in moisture accumulation on the inside of the windscreen even when the outside (fresh) air position is selected. If this happens, have the climate control air filter replaced by a HYUNDAI authorised repairer.

*** NOTICE**

- Replace the filter according to the Maintenance Schedule. If the car is being driven in severe conditions such as dusty, rough roads, more frequent climate control air filter inspections and changes are required.
- When the air flow rate is suddenly decreased, the system should be checked at a HYUNDAI authorised repairer.

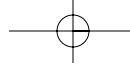

Features of your vehicle

D230400AFD-UK

Checking the amount of air conditioner refrigerant and compressor lubricant

When the amount of refrigerant is low, the performance of the air conditioning is reduced. Overfilling also has a bad influence on the air conditioning system.

Therefore, if abnormal operation is found, have the system inspected by a HYUNDAI authorised repairer.

*** NOTICE**

It is important when servicing the air conditioning system that the correct type and amount of oil and refrigerant is used. Otherwise, damage to the compressor and abnormal system operation may occur.

⚠ WARNING

The air conditioning system should be serviced by a HYUNDAI authorised repairer. Improper service may cause serious injury to the person performing the service.

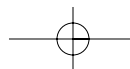
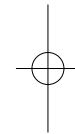
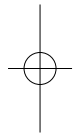

AUTOMATIC CLIMATE CONTROL SYSTEM (IF EQUIPPED)

Type A



1. Fan speed control button
2. Air conditioning button
3. Air intake control button
4. Front windscreen defrost button

5. AUTO (automatic control) button
6. OFF button
7. Temperature control knob
8. Rear window defrost button

9. Mode selection button
10. A/C display

OFD0471100

D240000AFD-UK

Features of your vehicle

Type B

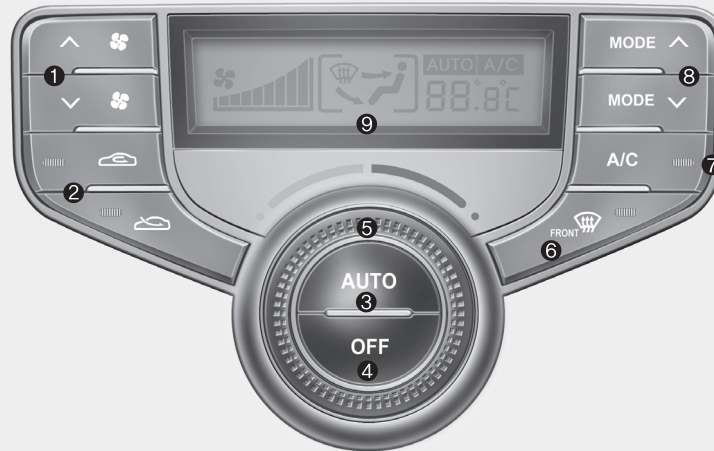

- 1. Fan speed control button
- 2. Air intake control button
- 3. AUTO (automatic control) button

- 4. OFF button
- 5. Temperature control knob
- 6. Front windscreen defrost button

- 7. Air conditioning button
- 8. Mode selection button
- 9. A/C display

OFD0471101

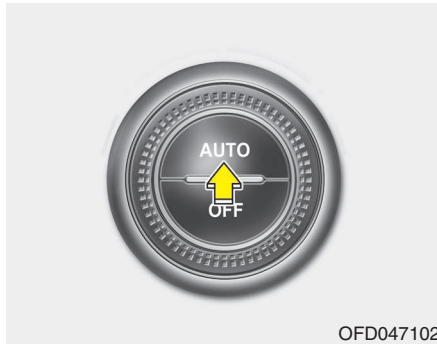

OFD047102

D240100AFD-UK

Automatic heating and air conditioning

The automatic climate control system is controlled by simply setting the desired temperature.

The Full Automatic Temperature Control (FATC) system automatically controls the heating and cooling system as follows;

1. Push the AUTO button. It is indicated by AUTO on the display. The modes, fan speeds, air intake and air-conditioning will be controlled automatically by temperature setting.

2. Turn the temperature control knob to set the desired temperature.

If the temperature is set to the lowest setting (Lo), the air conditioning system will operate continuously.

3. To turn the automatic operation off, press any button except temperature control knob. If you press the mode selection button, air-conditioning button*, defrost button, air intake control button* or fan speed button, the selected function will be controlled manually whilst other functions operate automatically. (* : type B only)

Regardless of the temperature setting, when using automatic operation, the air conditioning system can automatically turn on to decrease the humidity inside the vehicle, even if the temperature is set to warm.

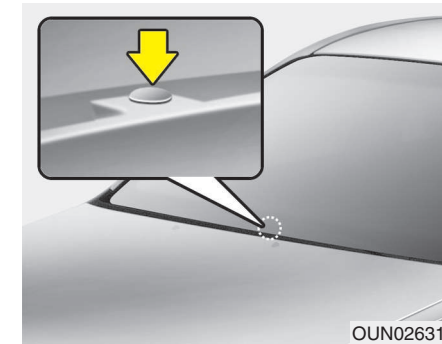

OUN026312

* NOTICE

Never place anything over the sensor located on the instrument panel to ensure better control of the heating and cooling system.

Features of your vehicle

D240200AUN-UK

Manual heating and air conditioning

The heating and cooling system can be controlled manually by pushing buttons other than the AUTO button. In this case, the system works sequentially according to the order of buttons selected.

When pressing any button (or turning any knob) except AUTO button whilst automatic operation, the functions not selected will be controlled automatically.

1. Start the engine.
2. Set the mode to the desired position.
3. Set the temperature control to the desired position.
4. Set the air intake control to the outside (fresh) air position.
5. Set the fan speed control to the desired speed.
6. If air conditioning is desired, turn the air conditioning system on.

Press the AUTO button in order to convert to full automatic control of the system.

Type A

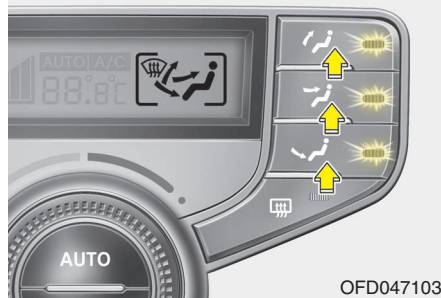

D240201AFD-UK

Mode selection

The mode selection button controls the direction of the air flow through the ventilation system.

Refer to the illustration in the "Manual climate control system".

Type A :

If you push the button once, the corresponding switch will turn on, and if you push the button again, the switch will turn off.



Face-Level (B, D)

Air flow is directed toward the upper body and face. Additionally, each outlet can be controlled to direct the air discharged from the outlet.



Floor-Level (C, E, A, D)

Most of the air flow is directed to the floor.



Defrost-Level (A, D)

Most of the air flow is directed to the windscreen.

Also you may select 2~3 modes at the same time for desired air flow.

- face () + floor () mode
- face () + defrost () mode
- floor () + defrost () mode
- face () + floor () + defrost () mode

Features of your vehicle

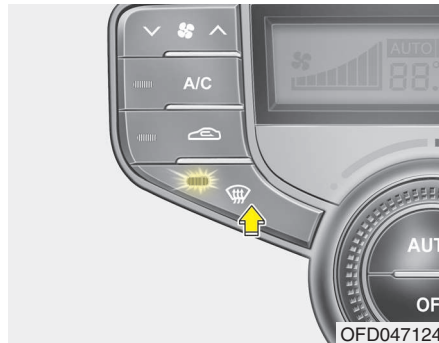





OFD047124

Maximum (MAX) defrost mode

When you select the MAX defrost mode, the following system settings will be made automatically;

- the air conditioning system will be turned on.
- the outside(fresh) air position will be selected.
- the fan speed will be set to the high speed.

To turn the MAX defrost mode off, press the mode button (, , ) or MAX () defrost button again or AUTO button

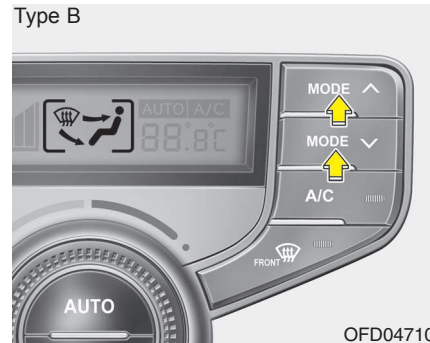

OFD047104

Type B:

The air flow outlet port is converted as follows:



Face-Level (B, D)

Air flow is directed toward the upper body and face. Additionally, each outlet can be controlled to direct the air discharged from the outlet.



Bi-Level (B, D, C, E)

Air flow is discharged towards the face and floor.



Floor-Level (C, E, A, D)

Most of the air flow is directed to the floor, with a small amount of the air being directed to the windscreen and side window defroster.



Floor/Defrost-Level (A, C, E, D)

Most of the air flow is directed to the floor and the windscreen with a small amount directed to the side window defrosters.

Features of your vehicle

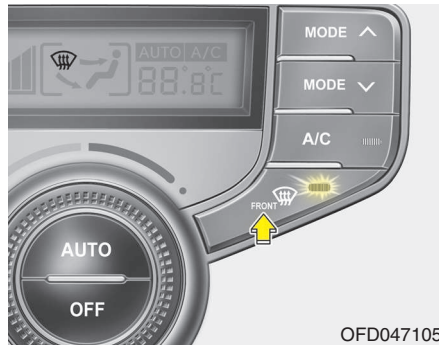

Defrost-level (A, D)

Most of the air flow is directed to the windscreen with a small amount of air directed to the side window defrosters.

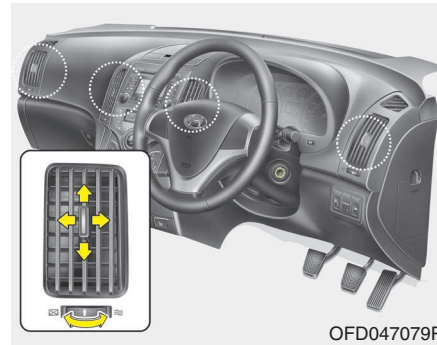

Instrument panel vents

The outlet port can be opened or closed separately using the horizontal thumbwheel. To close the vent, rotate it left to the maximum position. To open the vent, rotate it right to the desired position. Also, you can adjust the direction of air delivered from these vents using the vent control lever as shown.

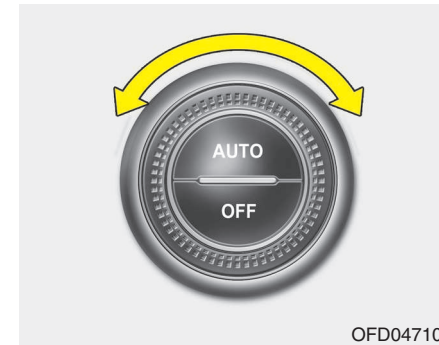

D240202AUN-UK

Temperature control

The temperature will increase to the maximum (HI) by turning the knob to the right extremely.

The temperature will decrease to the minimum (Lo) by turning the knob to the left extremely.

When turning the knob, the temperature will increase or decrease by 0.5°C/1°F. When set to the lowest temperature setting, the air conditioning will operate continuously.

Features of your vehicle

Temperature conversion

If the battery has been discharged or disconnected, the temperature mode display will reset to Centigrade.

This is normal condition. You can switch the temperature mode between Centigrade to Fahrenheit as follows;

Whilst depressing the AUTO button, depress the OFF button for 3 seconds or more. The display will change from Centigrade to Fahrenheit, or from Fahrenheit to Centigrade.

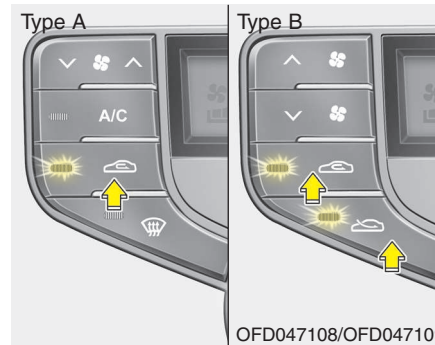

D240203AFD-UK

Air intake control

This is used to select outside (fresh) air position or recirculated air position.

To change the air intake control position, push the control button.

Recirculated air position



The indicator light on the button illuminates when the recirculated air position is selected.

With the recirculated air position selected, air from passenger compartment will be drawn through the heating system and heated or cooled according to the function selected.

Outside (fresh) air position



The indicator light on the button does not illuminate when the outside (fresh) air position is selected (type A).



With the outside (fresh) air position selected, air enters the vehicle from outside and is heated or cooled according to the function selected.

Features of your vehicle

* NOTICE

It should be noted that prolonged operation of the heating in recirculated air position will cause fogging of the windscreen and side windows and the air within the passenger compartment will become stale.

In addition, prolonged use of the air conditioning with the recirculated air position selected, will result in excessively dry air in the passenger compartment.

⚠ WARNING

- Continued climate control system operation in the recirculated air position may allow humidity to increase inside vehicle which may fog the glass and obscure visibility.
- Do not sleep in a vehicle with air conditioning or heating system on. It may cause serious harm or death due to a drop in the oxygen level and/or body temperature.
- Continued climate control system operation in the recirculated air position can cause drowsiness or sleepiness, and loss of vehicle control. Set the air intake control to the outside (fresh) air position as much as possible whilst driving.

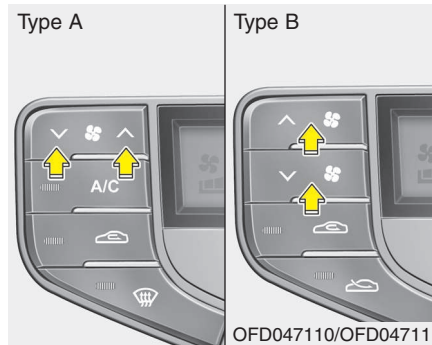

D240205AUN

Fan speed control

The fan speed can be set to the desired speed by pressing the fan speed control button.

The higher the fan speed is, the more air is delivered.

Pressing the OFF button turns off the fan.

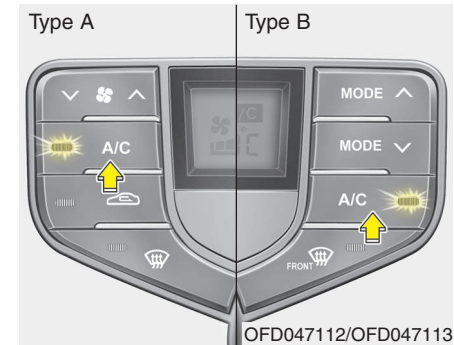

D240206AUN

Air conditioning

Push the A/C button to turn the air conditioning system on (indicator light will illuminate).

Push the button again to turn the air conditioning system off.

WINDSCREEN DEFROSTING AND DEFOGGING

D250000AUN-UK

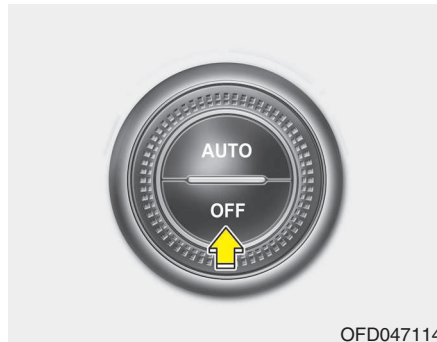

OFD047114

D240208AUN

OFF mode

Push the OFF button to turn off the air climate control system. However you can still operate the mode and air intake buttons as long as the ignition switch is in the position ON.

WARNING - Windscreen heating

Do not use the or position during cooling operation in extremely humid weather. The difference between the temperature of the outside air and that of the windscreen could cause the outer surface of the windscreen to fog up, causing loss of visibility. In this case, set the mode selection knob or button to the position and fan speed control knob or button to the lower speed.

- For maximum defrosting, set the temperature control to the extreme right/hot position and the fan speed control to the highest speed.
- If warm air to the floor is desired whilst defrosting or defogging, set the mode to the floor-defrost position.
- Before driving, clear all snow and ice from the windscreen, rear window, outside rear view mirrors, and all side windows.
- Clear all snow and ice from the bonnet and air inlet in the cowl grill to improve heater and defroster efficiency and to reduce the probability of fogging up inside of the windscreen.

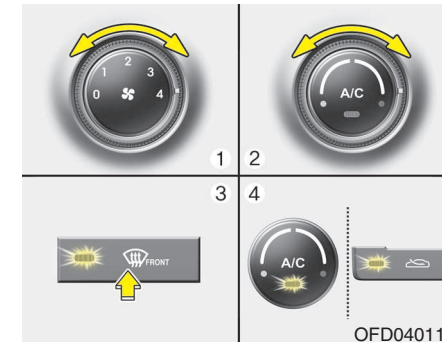

OFD040115

Manual climate control system

D250101AFD-UK

To defog inside windscreen

1. Select any fan speed except "0" position.
2. Select desired temperature.
3. Select the or position.
4. The outside (fresh) air and air conditioning will be selected automatically. If the air-conditioning and outside (fresh) air position are not selected automatically, press the corresponding button manually.

Features of your vehicle

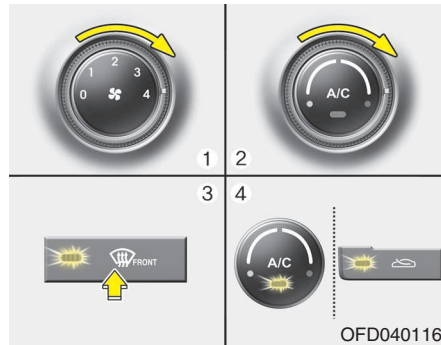

D250102AFD-UK

To defrost outside windscreen

1. Set the fan speed to the highest (extreme right) position.
2. Set the temperature to the extreme hot position.
3. Select the position.
4. The outside (fresh) air and air conditioning will be selected automatically.

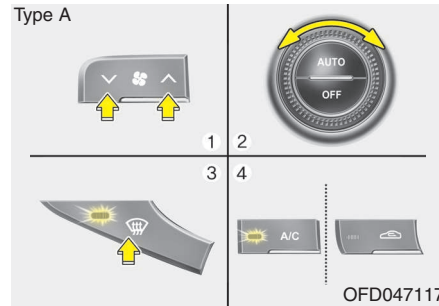

Type A

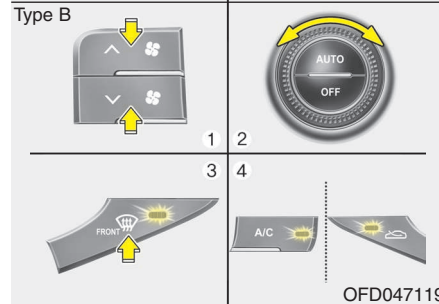

Automatic climate control system

D250201AFD-UK

To defog inside windscreen

1. Select desired fan speed.
2. Select desired temperature.
3. Press the defrost button ().

4. The air-conditioning will be turned on according to the detected ambient temperature, outside (fresh) air position and higher fan speed will be selected automatically.

If the air-conditioning, outside (fresh) air position and higher fan speed are not selected automatically, adjust the corresponding button or knob manually.

If the position is selected, lower fan speed is controlled to higher fan speed.

Features of your vehicle

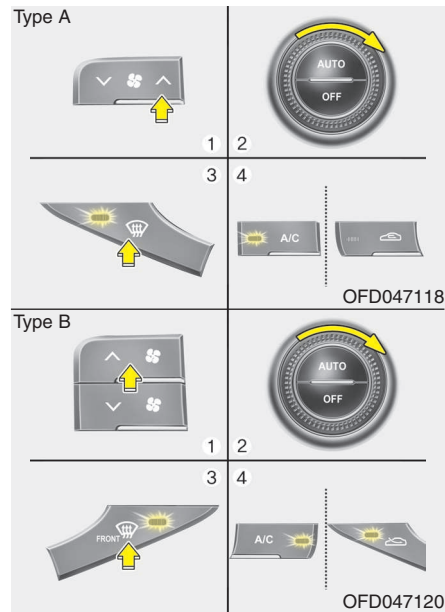

D250202AFD-UK



To defrost outside windscreen

1. Set fan speed to the highest position.
2. Set temperature to the extreme hot (HI) position.
3. Press the defrost button ().

4. The air-conditioning will be turned on according to the detected ambient temperature and outside (fresh) air position will be selected automatically. If the  position is selected, lower fan speed is controlled to higher fan speed.

D250300AUN-UK

Defogging logic

To reduce the possibility of fogging up the inside of the windscreen, the air intake or air conditioning are controlled automatically according to certain conditions such as  or  position. To cancel or return the defogging logic, do the followings.

Features of your vehicle

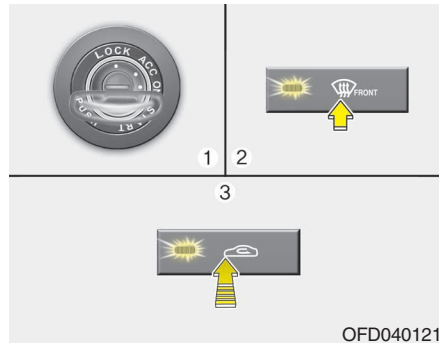

D250301AFD

Manual climate control system

1. Turn the ignition switch to the ON position.
2. Turn the mode selection knob to the defrost position (☀️).
3. Push the air intake control button (☁️) at least 5 times within 3 seconds.

The indicator light in the air intake control button will blink 3 times with 0.5 second of interval. It indicates that the defogging logic is canceled or returned to the programmed status.

If the battery has been discharged or disconnected, it is reset to the defog logic status.

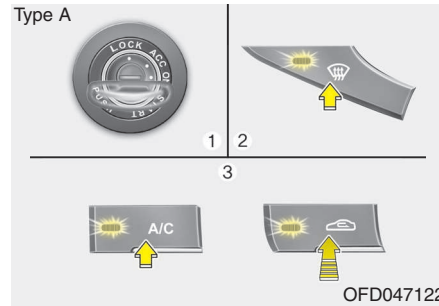

Type B

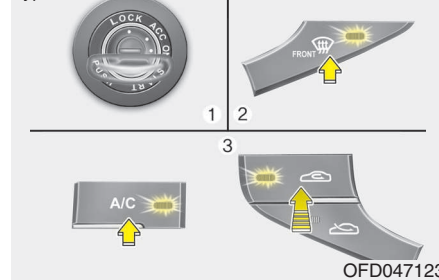

D250302AUN-UK

Automatic climate control system

1. Turn the ignition switch to the ON position.
2. Select the defrost position pressing defrost button (☀️).
3. Whilst holding the air conditioning button (A/C) pressed, press the air intake control button (☁️) at least 5 times within 3 seconds.

The A/C display blinks 3 times with 0.5 second of interval. It indicates that the defogging logic is canceled or returned to the programmed status.

If the battery has been discharged or disconnected, it is reset to the defog logic status.

STORAGE COMPARTMENT

D270000AUN-UK

These compartments can be used to store small items required by the driver or passengers.

CAUTION

- *To avoid possible theft, do not leave valuables in the storage compartment.*
- *Always keep the storage compartment covers closed whilst driving. Do not attempt to place so many items in the storage compartment that the storage compartment cover can not close securely.*

WARNING - Flammable materials

Do not store cigarette lighters, propane cylinders, or other flammable/explosive materials in the vehicle. These items may catch fire and/or explode if the vehicle is exposed to hot temperatures for extended periods.

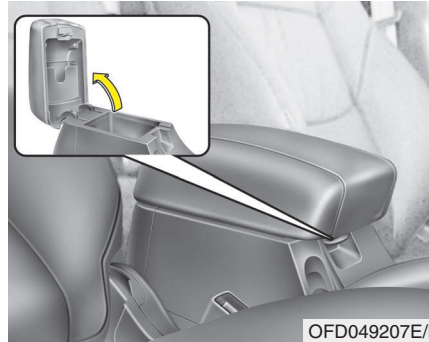

OFD049207E/H

D270100AFD-UK

Centre console storage (if equipped)

These compartments can be used to store small items required by the driver or front passenger.

To open the centre console storage pull up the lever.

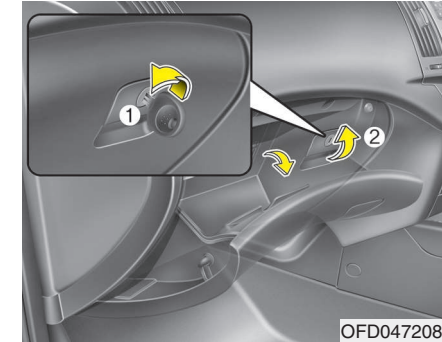

OFD047208R

D270200AFD-UK

Glove box

The glove box can be locked and unlocked with a master key.

To open the glove box, pull the handle and the glove box will automatically open. Close the glove box after use.

WARNING

To reduce the risk of injury in an accident or sudden stop, always keep the glove box door closed whilst driving.

Features of your vehicle

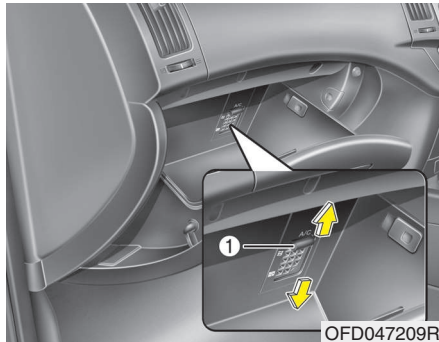

Glove box cooling (if equipped)

You can keep beverage cans or other items warm or cool using the open/close lever of the vent installed in the glove box.

1. Turn on the fan control switch.
2. Set the air flow control to the face () mode.
3. Turn the open/close lever of the vent installed in the glove box to the open position.
 - (1) OPEN
 - (2) CLOSE

4. Set the temperature control to warm or cool.

When the cool box is not used, turn the lever to its closed position.

*** NOTICE**

Whilst using the cooling function, a small amount of condensed moisture could damage your pieces of paper.

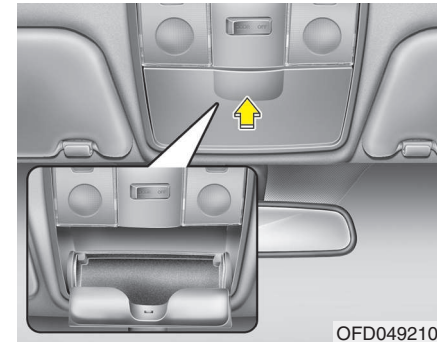

D270300AUN-UK

Sunglass holder

To open the sunglasses holder, press the cover and the holder will slowly open. Place your sunglasses in the compartment door with the lenses facing out. Push to close.

Features of your vehicle

⚠ WARNING

- Do not keep objects except sunglasses inside the sunglasses holder. Such objects can be thrown from the holder in the event of a sudden stop or an accident, possibly injuring the passengers in the vehicle.
- Do not open the sunglasses holder whilst the vehicle is moving. The rear view mirror of the vehicle can be blocked by an open sunglasses holder.

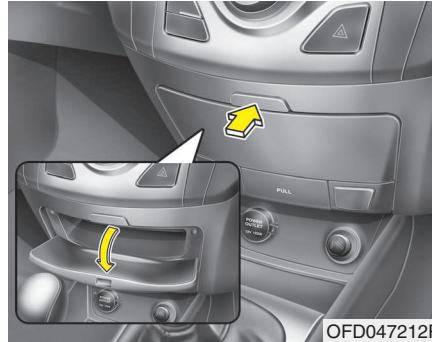

D270400AFD

Multi box

To open the cover, push the button. It can be used for storing small items.

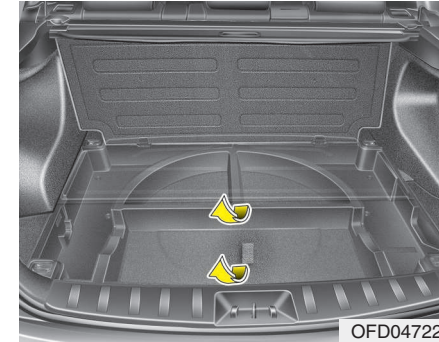

D270500AFD

Luggage box (if equipped)

You can place a first aid kit, a reflector triangle, tools, etc. in the box for easy access.

1. Grasp the handle on the top of the cover and lift it.

Features of your vehicle

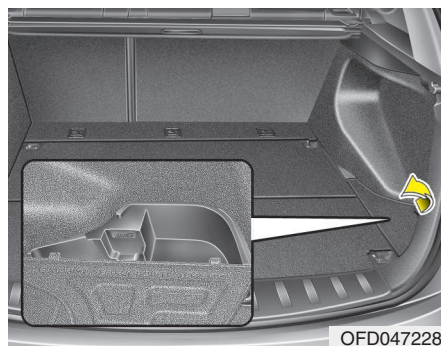

D270501AFD

Luggage side tray

To open the cover, pull up the handle and lift the cover (if equipped). It can be used for storing small items.

INTERIOR FEATURES

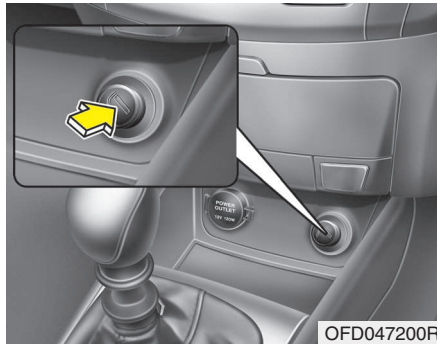

D280100AFD

Cigarette lighter

For the cigarette lighter to work, the ignition switch must be in the ACC position or the ON position.

To use the cigarette lighter, push it all the way into its socket. When the element has heated, the lighter will pop out to the "ready" position.

Do not hold the cigarette lighter pressed in. This can damage the heating element and create a fire hazard.

If it is necessary to replace the cigarette lighter, use only a genuine HYUNDAI replacement or its approved equivalent.

⚠ WARNING

- Do not hold the lighter in after it is already heated because it will overheat.
- If the lighter does not pop out within 30 seconds, remove it to prevent overheating.

⚠ CAUTION

Only a genuine HYUNDAI lighter should be used in the cigarette lighter socket. The use of plug-in accessories (shavers, hand-held vacuums, and coffee pots, for example) may damage the socket or cause electrical failure.

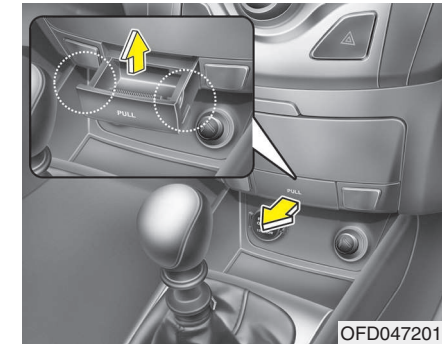

D280200AFD

Ashtray

⚠ WARNING - Ashtray use

- Do not use the vehicle's ashtrays as waste receptacles.
- Putting lit cigarettes or matches in an ashtray with other combustible materials may cause a fire.

The front ashtray may be opened by pulling the ashtray lid. To clean the ashtray, the plastic receptacle should be removed by lifting the plastic ash receptacle upward and pulling it out.

Features of your vehicle

D280300AUN-UK

Cup holder

⚠ WARNING - Hot liquids

- Do not place uncovered cups of hot liquid in the cup holder whilst the vehicle is in motion. If the hot liquid spills, you burn yourself. Such a burn to the driver could lead to loss of control of the vehicle.
- To reduce the risk of personal injury in the event of sudden stop or collision, do not place uncovered or unsecured bottles, glasses, cans, etc., in the cup holder whilst the vehicle is in motion.

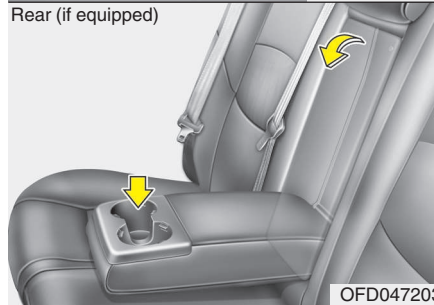
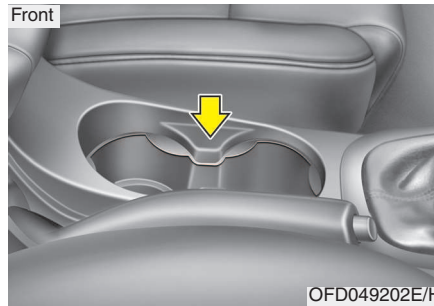

D280301AFD

Front

Cups or small beverage cans may be placed in the cup holders.

Rear (if equipped)

Cups may be placed in the cup holders.

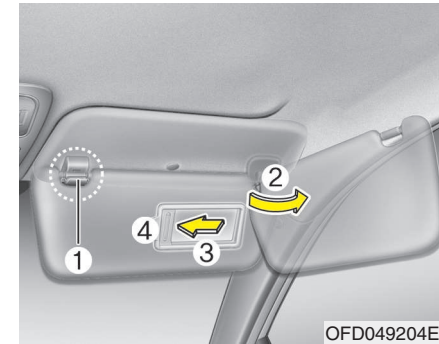

D280400AFD

Sunvisor

Use the sunvisor to shield direct light through the front or side windows.

To use a sunvisor, pull it downward.

To use a sunvisor for a side window, pull it downward, unsnap it from the bracket (1) and swing it to the side (2).

To use the vanity mirror, pull down the visor and slide the mirror cover (3).

The ticket holder (4) is provided for holding a tollgate ticket. (if equipped)

Features of your vehicle

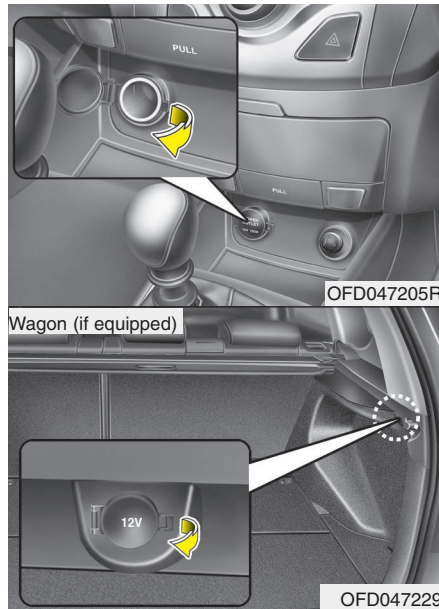

OFD047205R

Wagon (if equipped)

OFD047229

D280500AUN

Power outlet (if equipped)

The power outlet is designed to provide power for mobile telephones or other devices designed to operate with vehicle electrical systems. The devices should draw less than 10 amps with the engine running.

CAUTION

- *Use power outlet only when the engine is running and remove the accessory plug after use. Using the accessory plug for prolonged periods of time with the engine off could cause the battery to discharge.*
- *Only use 12V electric accessories which are less than 10A in electric capacity.*
- *Adjust the air-conditioner or heater to the lowest operating level when using the power outlet.*
- *Close the cover when not in use.*
- *Some electronic devices can cause electronic interference when plugged into a vehicle's power outlet. These devices may cause excessive audio static and malfunctions in other electronic systems or devices used in your vehicle.*



OFD047217

D280600AUN-UK

Digital clock (if equipped)

WARNING

Do not adjust the clock whilst driving. You may lose your steering control and cause severe personal injury or accidents.

Whenever the battery terminals or related fuses are disconnected, you must reset the time.

When the ignition switch is in the ACC or ON position, the clock buttons operate as follows:

Features of your vehicle

D280601AUN

• **HOUR:**

Pressing the “H” button (2) with your finger, a pencil or similar object will advance the time displayed by one hour.

D280602AUN

• **MINUTE:**

Pressing the “M” button (3) with your finger, a pencil or similar object will advance the time displayed by one minute.

D280603AUN-UK

• **RESET:**

To clear away minutes, press the “R” button (1) with your finger, a pencil or similar object. Then the clock will be set precisely on the hour.

For example, if the “R” button is pressed whilst the time is between 9:01 and 9:29, the display will be reset to 9:00.

9:01 ~ 9:29 display changed to 9:00

9:30 ~ 9:59 display changed to 10:00

D280604AUN-UK

• **Display conversion:**

To change the 12 hour format to the 24 hour format, press the “R” button (1) for more than 4 seconds.

For example, if the “R” button is pressed for more than 4 seconds whilst the time is 10:15 p.m., the display will be changed to 22:15.

* For the type of the clock built in the audio, refer to “Audio system” in this section.

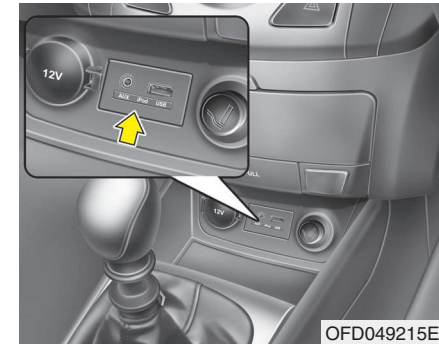

D281400BFD

Aux, USB and iPod (if equipped)

If your vehicle has an aux and/or USB(universal serial bus) port or iPod port, you can use an aux port to connect audio devices and an USB port to plug in an USB and also an iPod port to plug in an iPod.

* **NOTICE**

When using a portable audio device connected to the power outlet, noise may occur during playback. If this happens, use the power source of the portable audio device.

* iPod is a trademark of Apple Inc.

Features of your vehicle

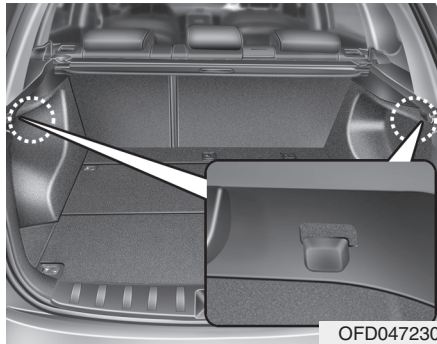

OFD047230

D280700AFD

Shopping bag holder (if equipped)

CAUTION

Do not hang a bag weighing more than 7 lbs. (3 kg). It may cause damage to the shopping bag holder.



OUN026348

D280800AUN

Clothes hanger (if equipped)

To use the hanger, pull down the upper portion of hanger.

CAUTION

Do not hang heavy clothes, since those may damage the hook.

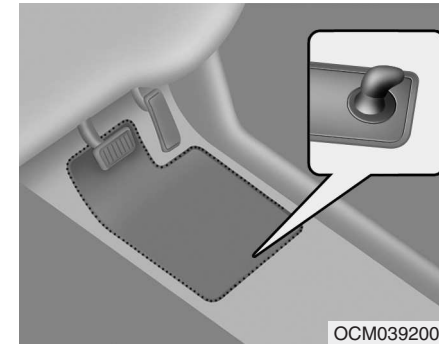

OCM039200N

B571A03Y-AAT

Floor mat anchor(s) (if equipped)

When using a floor mat on the front floor carpet, make sure it attaches to the floor mat anchor(s) in your vehicle. This keeps the floor mat from sliding forward.

WARNING

- Make sure the floor mat is properly placed on the floor carpet. If the floor mat slips and interferes with the movement of the pedals during driving, it may cause an accident.
- Don't put an additional floor mat on the top of the anchored floor mat, otherwise the additional mat may slide forward and interfere with the movement of the pedals.

Features of your vehicle

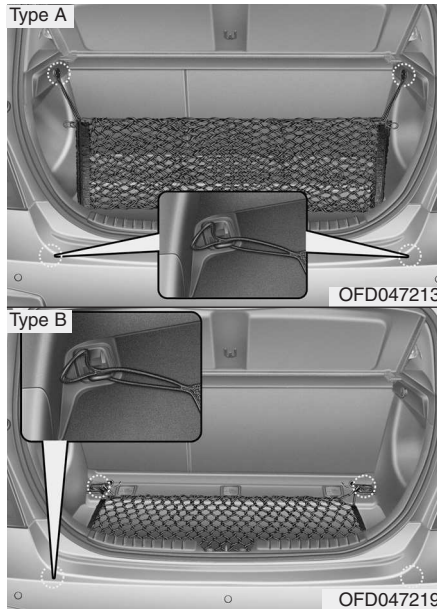

D281000AFD-UK

Luggage net (holder) (if equipped)

To keep items from shifting in the cargo area, you can use the four holders located in the cargo area to attach the luggage net.

If necessary, contact your HYUNDAI authorised repairer to obtain a luggage net.

For the full size spare tyre equipped vehicle : type A and type B available
 For the compact spare tyre equipped vehicle : type B available

CAUTION

To prevent damage to the goods or the vehicle, care should be taken when carrying fragile or bulky objects in the luggage compartment.

WARNING

Avoid eye injury. DO NOT overstretch. The luggage net ALWAYS keep your face and body out of the luggage net's recoil path. DO NOT use when the strap has visible signs of wear or damage.

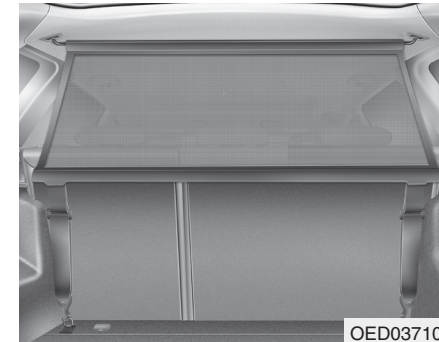

Barrier net (if equipped)

Your vehicle is equipped with a barrier net.

When you load some cargoes on the rear seat or rear cargo area, you must install the barrier net behind front seatback or rear seatback.

It is designed to help protect the heads of the occupants by obstructing objects flying forward in frontal collisions.

There are eight hook holders on both side of the headliner over the headrests for upper side fixation and on the floor behind the front seats or rear seats for lower side fixation.

Features of your vehicle

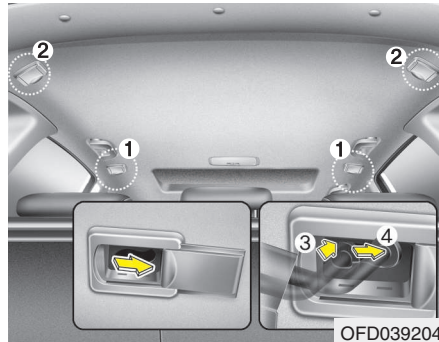

To install the barrier net

1. Open the cover for the holder position (1) or (2) you want to install.
2. Insert the net upper shaft into the large hole (3) and then secure by sliding into the small hole (4).

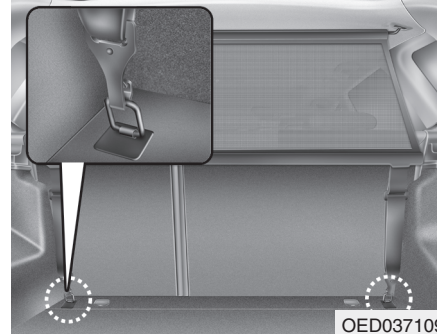
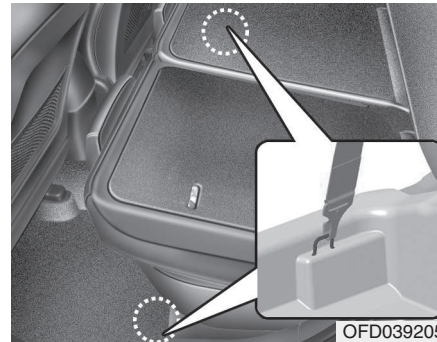

3. Hang the net strap hooks in the corresponding hook holders on the floor behind the front seat or rear seat.

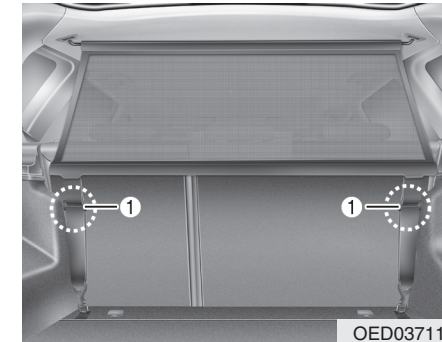

4. Fasten the straps, by using the adjuster (1).

⚠ WARNING

- Make sure that there is no slack in the barrier net by fastening the strap securely when installing the net. The strap should be fastened after confirming that the hook is inserted into the upper hook holder securely.
- Make sure that the seatbacks are locked securely.

Features of your vehicle

⚠ WARNING

- Do not put passengers in the rear seat or cargo area behind the barrier net.
- Do not put passenger in the rear centre seat when the barrier net is installed behind the rear seats. The barrier net may interfere with use of the rear centre safety belt.
- Do not load cargo in the area higher than the barrier net's upper end.
- Do not load heavy cargo in the area higher than the seatback to avoid accident even if the barrier net is installed.
- Do not load cargo which has sharp edge that can pass through the barrier net.
- Do not apply excessive force to the barrier net by hanging on to the net or by suspending heavy cargo and so on.

To remove the barrier net

1. Loosen the straps by using the strap adjusters and remove the strap hooks from the hook holders.
2. Remove the net upper shaft by pulling it through the large holes.
3. Remove the barrier net.

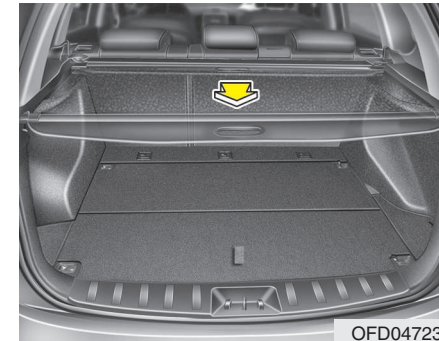

OFD047231

D281100AFD

Cargo security screen (if equipped)

Use the cargo security screen to hide items stored in the cargo area.

Features of your vehicle

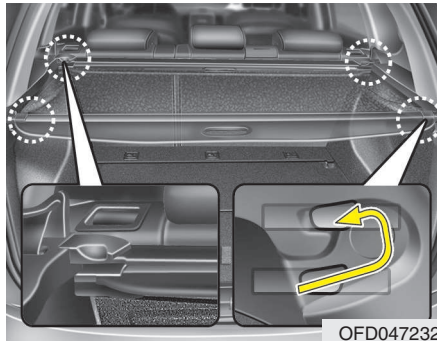

- To use the cargo security screen, pull the handle backward and insert the edges into the slots.

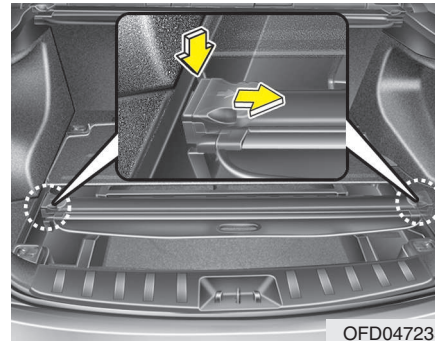

When not in use, place the cargo security screen on the lower portion of the cargo area.

⚠ WARNING

- Do not place objects on the cargo security screen. Such objects may be thrown about inside the vehicle and possibly injure vehicle occupants during an accident or when braking.
- Never allow anyone to ride in the luggage compartment. It is designed for luggage only.
- Maintain the balance of the vehicle and locate the weight as far forward as possible.

⚠ CAUTION

Since the cargo security screen may be damaged or malformed, do not put the luggage on it when it is used.

Features of your vehicle

EXTERIOR FEATURES

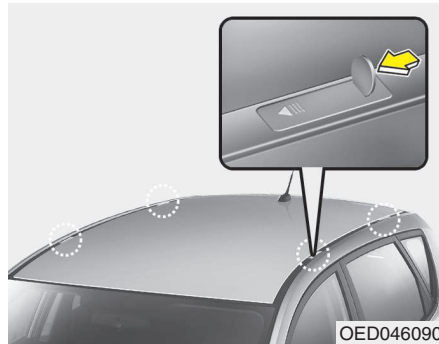

D290300AFD-UK

Mounting bracket for roof carrier (if equipped)

To install or remove a roof carrier, you can use the mounting bracket and cover on the roof.

When you install a roof carrier, use the following procedure.

1. Insert a slim tool (coin or flat blade driver) into the slot and slide the cover toward the arrow on the cover.

⚠ WARNING

Use a coin or flat blade driver when you remove the roof carrier cover. If you use your fingernail, it may damage your fingernail.

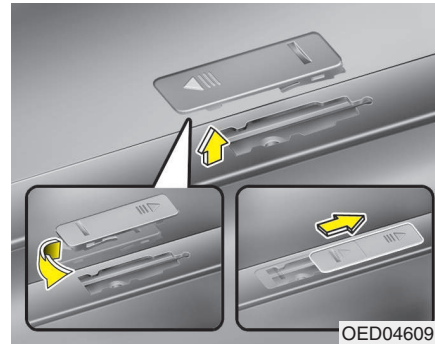

2. Rotate the cover half way and insert the cover on the roof hole as the illustration.

Maximum roof carrier load

176 lbs. (80 kg)

*** NOTICE**

To prevent loosening the roof carrier cover, install the cover on the roof before you install the roof carrier.

3. After using the roof carrier, install the cover back on the roof in the reverse order.

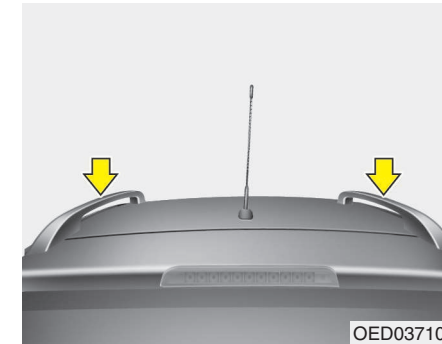

D290100AFD-UK

Roof rack (if equipped)

If the vehicle has a roof rack, you can load cargo on top of your vehicle.

*** NOTICE**

If the vehicle is equipped with a sunroof, be sure not to position cargo onto the roof rack in such a way that it could interfere with sunroof operation.

⚠ CAUTION

- *When carrying cargo on the roof rack, take the necessary precautions to make sure the cargo does not damage the roof of the vehicle.*
- *When carrying large objects on the roof rack, make sure they do not exceed the overall roof length or width.*

⚠ WARNING

- The following specification is the maximum weight that can be loaded onto the roof rack. Distribute the load as evenly as possible onto the roof rack and secure the load firmly.

ROOF RACK	176 lbs. (80 kg) EVENLY DISTRIBUTED
-----------	--

Loading cargo or luggage in excess of the specified weight limit on the roof rack may damage your vehicle.

- The vehicle centre of gravity will be higher when items are loaded onto the roof rack. Avoid sudden starts, braking, sharp turns, abrupt manoeuvres or high speeds that may result in loss of vehicle control or rollover resulting in an accident.

(Continued)

(Continued)

- Always drive slowly and turn corners carefully when carrying items on the roof rack. Severe wind updrafts, caused by passing vehicles or natural causes, can cause sudden upward pressure on items loaded on the roof rack. This is especially true when carrying large, flat items such as wood panels or mattresses. This could cause the items to fall off the roof rack and cause damage to your vehicle or others around you.
- To prevent damage or loss of cargo whilst driving, check frequently before or whilst driving to make sure the items on the roof rack are securely fastened.

Features of your vehicle

AUDIO SYSTEM

* NOTICE

If you install an aftermarket HID head lamp, your vehicle's audio and electronic device may malfunction.

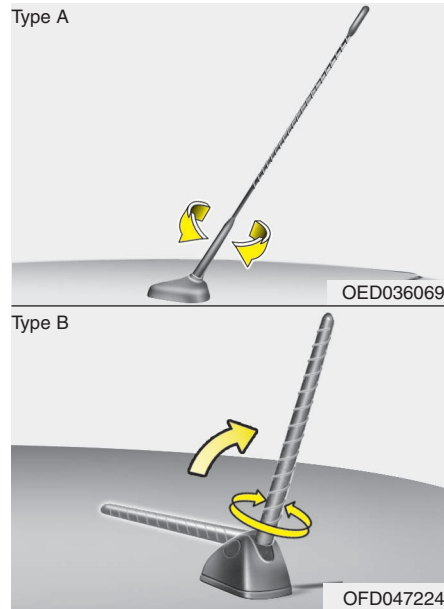

⚠ CAUTION

- Before entering a place with a low height clearance, be sure that the antenna is fully folded down or removed.
- Be sure to remove the antenna before washing the car in an automatic car wash or it may be damaged.
- When reinstalling your antenna, it is important that it is fully tightened and adjusted to the upright position to ensure proper reception. But it could be folded or removed when parking the vehicle or when loading cargo on the roof rack.
- When cargo is loaded on the roof rack, do not place the cargo near the antenna pole to ensure proper reception.

Antenna

D300102AFD

Roof antenna

Your car uses a roof antenna to receive both AM and FM broadcast signals. This antenna is a removable type. To remove the antenna, turn it counterclockwise. To install the antenna, turn it clockwise.

Features of your vehicle

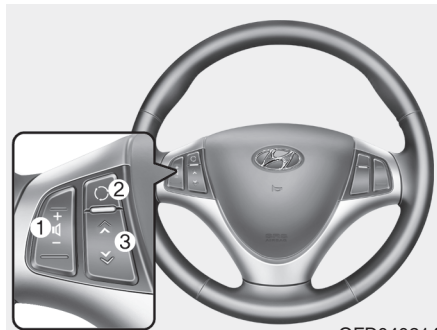

OFD040214

D300200AFD

Audio remote control (if equipped)

The steering wheel audio remote control button is installed to promote safe driving.

CAUTION

Do not operate audio remote control buttons simultaneously.

VOLUME (1)

- Press the up button (+) to increase volume.
- Press the down button (-) to decrease volume.

MODE (2)

Press the button to select Radio or CD (compact disc).

SEEK (3)

If the SEEK button is pressed for 0.8 second or more, it will work as follows in each mode.

RADIO mode

It will function as the FAST SEEK UP/DOWN select button.

CDP mode

It will function as the FF/REW button.

CDC mode

It will function as the DISC UP/DOWN button.

If the SEEK button is pressed for less than 0.8 second, it will work as follows in each mode.

RADIO mode

It will function as the PRESET STATION select buttons.

CDP mode

It will function as the TRACK UP/DOWN button.

CDC mode

It will function as the TRACK UP/DOWN button.

Detailed information for audio control buttons is described in the following pages in this section.

Features of your vehicle

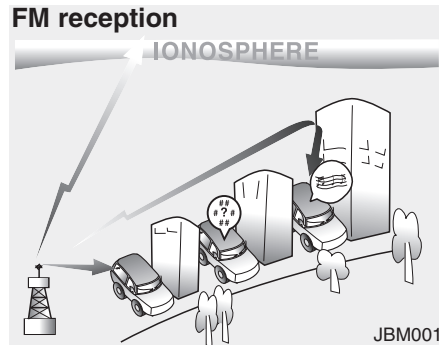

D300800AFD-UK

How car audio works

AM and FM radio signals are broadcast from transmitter towers located around your city. They are intercepted by the radio antenna on your car. This signal is then received by the radio and sent to your car speakers. When a strong radio signal has reached your vehicle, the precise engineering of your audio system ensures the best possible quality reproduction. However, in some cases the signal coming to your vehicle may not be strong and clear. This can be due to factors such as the distance from the radio station, closeness of other strong radio stations or the presence of buildings, bridges or other large obstructions in the area.

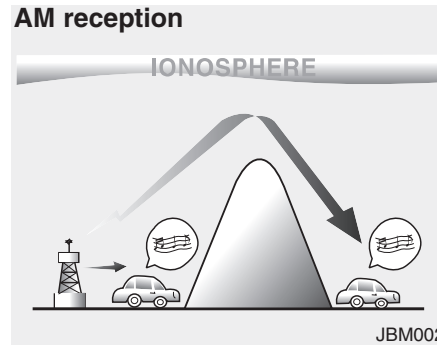

AM broadcasts can be received at greater distances than FM broadcasts. This is because AM radio waves are transmitted at low frequencies. These long, low frequency radio waves can follow the curvature of the earth rather than travelling straight out into the atmosphere. In addition, they curve around obstructions so that they can provide better signal coverage.

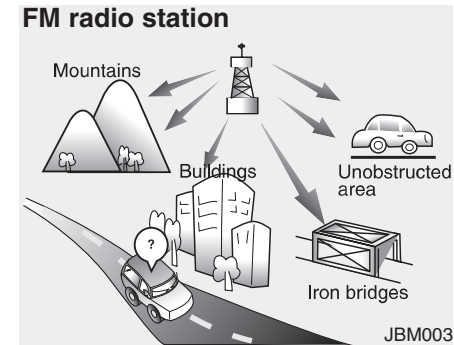

FM broadcasts are transmitted at high frequencies and do not bend to follow the earth's surface. Because of this, FM broadcasts generally begin to fade at short distances from the station. Also, FM signals are easily affected by buildings, mountains, or other obstructions. These can result in certain listening conditions which might lead you to believe a problem exists with your radio. The following conditions are normal and do not indicate radio trouble:

Features of your vehicle

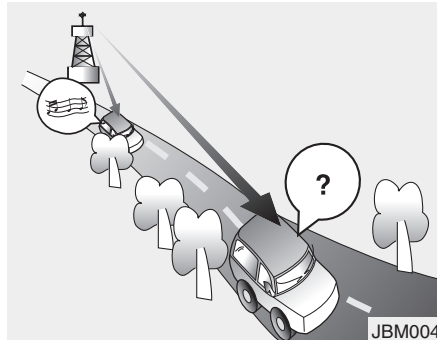

- **Fading** - As your car moves away from the radio station, the signal will weaken and sound will begin to fade. When this occurs, we suggest that you select another stronger station.
- **Flutter/Static** - Weak FM signals or large obstructions between the transmitter and your radio can disturb the signal causing static or fluttering noises to occur. Reducing the treble level may lessen this effect until the disturbance clears.

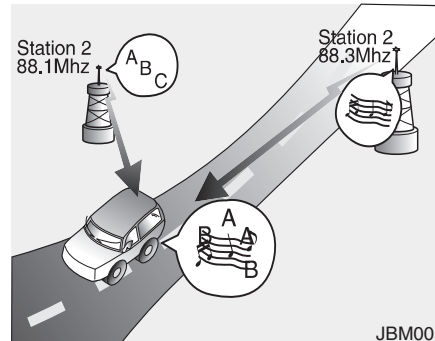

- **Station Swapping** - As a FM signal weakens, another more powerful signal near the same frequency may begin to play. This is because your radio is designed to lock onto the clearest signal. If this occurs, select another station with a stronger signal.
- **Multi-Path Cancellation** - Radio signals being received from several directions can cause distortion or fluttering. This can be caused by a direct and reflected signal from the same station, or by signals from two stations with close frequencies. If this occurs, select another station until the condition has passed.

Using a mobile phone or a two-way radio

When a mobile phone is used inside the vehicle, noise may be produced from the audio equipment. This does not mean that something is wrong with the audio equipment. In such a case, use the mobile phone at a place as far as possible from the audio equipment.

CAUTION

When using a communication system such a mobile phone or a radio set inside the vehicle, a separate external antenna must be fitted. When a mobile phone or a radio set is used with an internal antenna alone, it may interfere with the vehicle's electrical system and adversely affect safe operation of the vehicle.

WARNING

Don't use a mobile phone when you are driving. You must stop at a safe place to use a mobile phone.

Features of your vehicle

Care of disc (if equipped)

- If the temperature inside the car is too high, open the car windows for ventilation before using your car audio.
- It is illegal to copy and use MP3/WMA/AAC/WAVE files without permission. Use CDs that are created only by lawful means.
- Do not apply volatile agents such as benzene and thinner, normal cleaners and magnetic sprays made for analogue disc onto CDs.
- To prevent the disc surface from getting damaged. Hold and carry CDs by the edges or the edges of the centre hole only.
- Clean the disc surface with a piece of soft cloth before playback (wipe it from the centre to the outside edge).
- Do not damage the disc surface or attach pieces of sticky tape or paper onto it.
- Make sure on undesirable matter other than CDs are inserted into the CD player (Do not insert more than one CD at a time).
- Keep CDs in their cases after use to protect them from scratches or dirt.

- Depending on the type of CD-R/CD-RW CDs, certain CDs may not operate normally according to manufacturing companies or making and recording methods. In such circumstances, if you still continue to use those CDs, they may cause the malfunction of your car audio system.

* NOTICE - Playing an Incompatible Copy-Protected Audio CD

Some copy protected CDs, which do not comply with the international audio CD standards (Red Book), may not play on your car audio. Please note that if you try to play copy protected CDs and the CD player does not perform correctly the CDs maybe defective, not the CD player.

Features of your vehicle

RADIO, SET UP, VOLUME CONTROL (PA710R) (IF EQUIPPED)



1. FM Selection Button
2. AM Selection Button
3. TA Selection Button
4. CD/AUX Selection Button
5. Automatic Channel Selection Button
6. Power ON/OFF
7. AUTO STORE Button
8. Screen ON/ OFF Button
9. Information Display Button
10. SET UP Button
11. TUNE/ENTER Button
12. PTY(FLDR) Button
13. Preset Button

A-200FDE

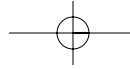

Features of your vehicle

1. FM Selection Button

Turns to FM mode and toggles in the order of FM1→FM2→FMA→FM1... when the button is pressed each time.

2. AM Selection Button

Turns to AM mode, and toggles AM and AMA when the button is pressed each time.

3. TA Selection Button

In FM, CD, AUX mode, turns on/off the reception of TA channels of RDS.

4. CD/AUX Selection Button

If there is a cd in the CDP DECK it turns to CD mode, and if a device is connected to AUX then it toggles.

CD→AUX→CD... when the button is pressed each time.(It will not turn to AUX if the auxiliary device is not connected.)

5. Automatic Channel Selection Button

- When the [SEEK ∨] button is pressed, it reduces the band frequency by 50khz to automatically select channel. Stops at the previous frequency if no channel is found.
- When the [SEEK ^] button is pressed, it increases the band frequency by 50khz to automatically select channel. Stops at the previous frequency if no channel is found.

6. Power ON/OFF & Volume Control Button

- Turns on/off the set when the IGNITION SWITCH is on ACC or ON. If the button is turned to the right, it increases the volume and left, decreases the volume.
- In AUX mode, the volume and tone (BASS, MID, TRE) are adjusted in a separate way.
If you pull out AUX from a jack and insert it again, then only volume goes back to 10-step.

7. AUTO STORE Button

- When you press the [AST] button, the mode changes to 'Auto store Band' and it saves the result.
(FM1 or FM2 changes to FMA, AM changes to AMA.)
- When the button is pressed, it automatically selects and saves channels with high reception rate to PRESET buttons (1~6) and plays the channel saved in PRESET1.
If no channel is saved after AST, it will play the previous channel.

8. Screen ON/ OFF Button

Turns off/on the displayed data and light on LCD.

The screen and light will be turned on by pressing any button except DARK button when the screen is turned off.

9. Information Display Button

Displays the information of the channel currently played by RDS.

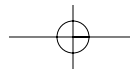
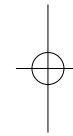
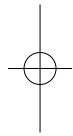

10. SET UP Button

Press this button to turn to the SOUND, RDS option, clock setting, time display, SCROLL, SDVC, temperature display and adjustment mode.

If no action is taken for 5 seconds after pressing the button, it will return to the play mode. (After entering SET UP mode, move between items using the left, right and PUSH functions of the TUNE button.)

The set up item changes from AUDIO → RDS → CLOCK → TIME → SCROLL → SDVC → TEMP → P.BASS → AUDIO

The manual setting is a default for radio time but if customer wants, the time received from RDS station can be set for radio time. In this case, the RDS time, which is effected by the situation of RDS station, can be different with actual time.

*** TO SETUP TIME UPDATE**

1. Press SETUP button.
2. Select RDS menu by rotating/pressing TUNE knob.
3. Select TIME menu by rotating/pressing TUNE knob.
4. Select Auto or Manual by rotating/pressing TUNE knob.
5. Press SETUP button to exit SETUP mode.

11. TUNE/ENTER Button

Turn this button clockwise by one notch to increase frequency by 0.05Mhz from current frequency.

Turn this button counterclockwise by one notch to decrease frequency by 0.05Mhz from current frequency.

Press this button whilst holding SET UP button to activate / inactivate the item to. Select SET UP item using left and right function of the Tune button.

12. PTY(FLDR) button

- Moves [PTY √] Button when searching PTY in RDS Broadcasting Program Type selection.
- Moves [PTY ^] button when searching PTY in RDS Broadcasting Program Type selection.

13. Preset Button

Push [1]~[6] buttons less than 0.8 second to play the channel saved in each button.

Push preset button for 0.8 second or longer to save current channel to the respective button with a beep.

Features of your vehicle

CD (PA710R) (IF EQUIPPED)

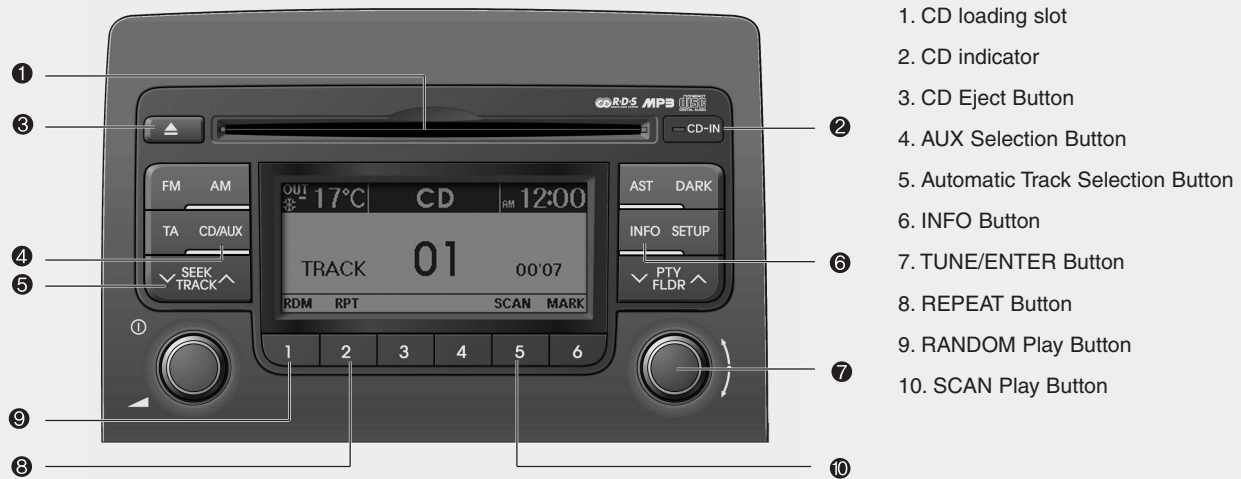

A-200FDE

1. CD loading slot

Please face printed side upward and gently push in. When the ignition switch is on ACC or ON and power is off, power is automatically turned on if the CD is loaded. This CDP supports both 8cm and 12 cm CDs. But if VCD, Data CD, MP3 CD are loaded, "Er-6" message will appear and CD will be ejected.

2. CD Indicator

When car ignition switch is ACC or ON and if the CD is loaded, this indicator is lighted. If the CD is ejected the light is turned off.

3. CD eject Button





Push  button to eject the CD during CD playback. This button is enabled when ignition switch is off.

4. AUX Selection Button

If the auxiliary device is connected, it turns to AUX MODE to play the sound from the auxiliary player.

If no Disc and auxiliary device is connected, it displays "NO Media" for 5 seconds and returns to the previous mode.

5. Automatic Track Selection Button

- Push [SEEK ] button for less than 0.8 second to play from the beginning of current song.
- Push [SEEK ] button for less than 0.8 second and press again within 1 second to play the previous song.
- Push [SEEK ] button for 0.8 second or longer to initiate reverse direction high speed sound search of current song.
- Push [SEEK ] button for less than 0.8 second to play the next song.
- Push [SEEK ] button for 0.8 second or longer to initiate high speed sound search of current song.

6. INFO Button

Displays the information of the current CD TRACK in the order of DISC TITLE→DISC ARTIST→TRACK TITLE→TRACK ARTIST→TOTAL TRACK→ Play Screen→DISC TITLE→... (not displayed if the information is not available on the DISC.)

7. TUNE/ENTER Button

Turn this button clockwise to display songs after current song.

Also, turn this button counterclockwise to display songs before current song.

To listen to the displayed song, press the button to skip to the song and play.

8. REPEAT Button

Repeats current song when the button is pressed for less than 0.8 second.

Repeats the entire DISC when the button is pressed for 0.8 second or longer.

9. RANDOM Play Button

Turns on/off the randomization of the play list of files in the currently played DISC.

To cancel the mode, press the key once again.

10. SCAN Play Button

Plays first 10 seconds of each song in the DISC.

To cancel the mode, press the key once again.

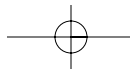

Features of your vehicle

USING USB (PA710R) (IF EQUIPPED)



1. AUX Selection Button
2. Track moving Button
3. INFO Selection Button
4. Folder moving Button
5. TUNE/ENTER Button
6. RANDOM Playback Button
7. REPEAT Selection Button
8. SCAN Selection Button

A-200FDE

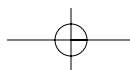

In case USB is connected to the multiple terminal inside the console on the left hand side of the driver's seat. When USB is connected, the 'USB' icon will be displayed on the top right corner of the display screen.

1. AUX Selection Button

If USB is connected, it switches to the USB mode from the CD mode to play the song files stored in the USB.

If there are no CD and USB mode from the Radio mode, it displays 'NO MEDIA'.

2. Track Moving Button

- Press the [SEEK √] button for less than 0.8 second to play from the beginning of the song currently played. Press the button for less than 0.8 second and press it again within 1 second to move to and play the previous track. Press the button for 0.8 second or longer to play the song in reverse direction in fast speed.
- Press the [SEEK ^] button for less than 0.8 second to move to the next track. Press the button for 0.8 second or longer to play the song in forward direction in fast speed.

3. INFO Button

Displays the information of the file currently played in the order of FILE NAME → TITLE → ARTIST → ALBUM → FOLDER → TOTAL FILE → FILE NAME → ... (Displays no information if the file has no song information.)

4. Folder moving Button

- Moves [FLDR √] button child folder of the current folder and displays the first song in the folder. Press TUNE/ENTER button to move to the folder displayed. It will play the first song in the folder.
- Moves [FLDR ^] button parent folder and displays the first song in the folder. Press TUNE/ENTER button to move to the folder displayed. It will play the first song in the folder.

5. TUNE/ENTER Button

Turn this button clockwise to display the songs next to the currently played song. Turn the button counterclockwise to display the songs before the currently played song. Press the button to skip to and play the selected song.

6. RANDOM Playback Button

Press the button for less than 0.8 second to start or stop the random playback of the songs in the current folder.

Press the button for more than 0.8 second to randomly play the entire songs in the USB device.

Press the button again to cancel the mode.

7. REPEAT Button

Press the button for less than 0.8 second to repeat the song currently played.

Press the button for more than 0.8 second to repeat the entire songs in the USB device.

8. SCAN Button

Plays 10 seconds of each song in the USB device.

Press the button once again to cancel scanning.

Features of your vehicle

CAUTION - Using USB device

- *To use an external USB device, make sure the device is not mounted when starting up the vehicle and mount the device after starting up.*
- *If you start the vehicle when the USB device is mounted, it may damage the USB device. (USB is not ESA)*
- *If the vehicle is started up or turned off whilst the external USB device is connected, the external USB device may not work.*
- *It may not play inauthentic MP3 or WMA files.*
 - 1) *It can only play MP3 files with the compression rate between 8Kbps~320Kbps.*
 - 2) *It can only play WMA music files with the compression rate between 8Kbps~320Kbps.*
- *Take cautions for static electricity when mounting or dismounting the external USB device.*
- *An encoded MP3 PLAYER is not recognizable.*

(Continued)

(Continued)

- *Depending on the condition of the external USB device, the connected external USB device can be unrecognizable.*
- *When the formatted byte/sector setting of External USB devices is not either 512BYTE or 2048BYTE, then the device will not be recognized.*
- *Use only a USB device formatted to FAT 12/16/32.*
- *USB devices without USB IF authentication may not be recognizable.*
- *Make sure the USB connection terminal does not come in contact with a human body or any object.*
- *If you repeat mounting or dismounting USB device in a short period of time, it may break the device.*
- *You might hear a strange noise when mounting or dismounting a USB device.*

(Continued)

(Continued)

- *If you dismount the external USB device during playback in USB mode, the external USB device can be damaged or malfunction. Therefore, mount the external USB device when the engine is turned off or in another mode.*
- *Depending on the type and capacity of the external USB device or the type of the files stored in the device, there is a difference in the time taken for recognition of the device, but this is not an indicator of trouble and you only have to wait.*
- *Do not use the USB device for other purposes than playing music files.*
- *Use of USB accessories such as recharger or heater using USB I/F may lower performance or cause trouble.*
- *If you use devices such as a USB hub you purchased separately, the vehicle's audio system may not recognize the USB device. Connect the USB device directly to the multimedia terminal of the vehicle.*

(Continued)

(Continued)

- *If USB device is divided by logical drives, only the music files on the highest-priority drive are recognized by car audio.*
- *Devices such as MP3 Player/Mobile phone/Digital camera those are not recognizable by standard USB I/F can be unrecognizable.*
- *USB devices other than standardized goods (METAL COVER TYPE USB) can be unrecognizable.*
- *USB flash memory reader (such as CF, SD, microSD, etc.) or external-HDD type devices can be unrecognizable.*
- *Music files protected by DRM (DIGITAL RIGHTS MANAGEMENT) are not recognizable.*
- *The data in the USB memory may be lost whilst using this AUDIO. It is recommended to back up important data on a personal.*

(Continued)

(Continued)

- *Please avoid using USB memory products which can be used as key chains or mobile phone accessories as they could cause damage to the USB jack. Please make certain only to use plug type connector products as shown below.*



Features of your vehicle

RUNNING iPod (PA710R) (IF EQUIPPED)



1. iPod Selection Button
2. Track moving Button
3. INFO Selection Button
4. Category Selection Button
5. TUNE/ENTER Button
6. RANDOM Playback Button
7. REPEAT Selection Button

* iPod is a trademark of Apple Inc.

A-200FDE

In case the iPod exclusive cable is connected to the multiple terminal inside the console on the left hand side of the driver's seat. When the iPod is connected, the 'iPod' icon will be displayed on the top right corner of the display screen.

1. iPod Selection Button

If iPod is connected, it switches to the iPod mode from the CD mode to play the song files stored in the iPod.

If there are no CD and AUX mode from the Radio mode, it displays 'NO MEDIA'.

2. Track Moving Button

- Press the [SEEK ∇] button for less than 0.8 second to play from the beginning of the song currently played.

Press the button for less than 0.8 second and press it again within 1 second to move to and play the previous track.

Press the button for 0.8 second or longer to play the song in reverse direction in fast speed.

- Press the [SEEK \wedge] button for less than 0.8 second to move to the next track.

Press the button for 0.8 second or longer to play the song in forward direction in fast speed.

3. INFO Button

Displays the information of the file currently played in the order of FILE NAME \rightarrow TITLE \rightarrow ARTIST \rightarrow ALBUM \rightarrow FILE NAME \rightarrow ...

(Displays no information if the file has no song information.)

4. Category Selection Button

Moves to the upper category from currently played category of the iPod.

To move to (play) the category (song) displayed, press TUNE/ENTER button.

You will be able to search through the lower category of the selected category.

The order of iPod's category is SONG, ALBUMS, ARTISTS, GENRES, and iPod.

5. TUNE/ENTER Button

When you turn the button clockwise, it will display the songs (category) next to the song currently played (category in the same level).

Also, when you turn the button counter-clockwise, it will display the songs (category) before the song currently played (category in the same level).

If you want to listen to the song displayed in the song category, press the button, then it will skip to the selected song and play.

6. RANDOM Playback Button

Press the button for less than 0.8 second to activate or deactivate the random playback of the songs within the current category.

Press the button for longer than 0.8 second to randomly play all songs in the entire album of the iPod.

Press the button once again to cancel the mode.

7. REPEAT Button

Repeats the song currently played.

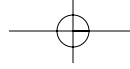

Features of your vehicle

* NOTICE - Using iPod device

- Some iPod models might not support the communication protocol and the files will not be played. (iPod models supported: Mini, 4G, Photo, Nano, 5G)
- The order of search or playback of songs in the iPod can be different from the order searched in the audio system.
- If the iPod crashes due to its own trouble, reset the iPod. (Reset: Refer to iPod manual)
- An iPod may not operate normally on low battery.

CAUTION - Using iPod device

- *You need the power cable exclusive for an iPod in order to operate an iPod with the buttons on the audio system. The PC cable provided by Apple may cause a malfunction and do not use it for vehicle use.*
- *When connecting the device with an iPod cable, push in the jack fully to not to interfere with communication.*
- *When adjusting the sound effects of an iPod and the audio system, the sound effects of both devices will overlap and might reduce or distort the quality of the sound.*
- *Deactivate (turn off) the equalizer function of an iPod when adjusting the audio system's volume, and turn off the equalizer of the audio system when using the equalizer of an iPod.*

(Continued)

(Continued)

- *When the iPod cable is connected, the system can be switched to the AUX mode even without the iPod device and can cause noise. Disconnect the iPod cable when you are not using the iPod device.*
- *When the iPod is not used for the audio system, the iPod cable has to be separate from iPod devices. Origin display of iPod may not be displayed.*

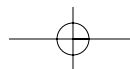
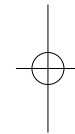
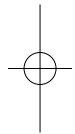

Features of your vehicle

RADIO, SET UP, VOLUME CONTROL (PA760R) (IF EQUIPPED)



1. FM Selection Button
2. AM Selection Button
3. TA Selection Button
4. CD/AUX Selection Button
5. Automatic Channel Selection Button
6. Power ON/OFF
7. AUTO STORE Button
8. Screen ON/ OFF Button
9. Information Display Button
10. SET UP Button
11. TUNE/ENTER Button
12. PTY(FLDR) Button
13. Preset Button

A-300FDE

Features of your vehicle

1. FM Selection Button

Turns to FM mode and toggles in the order of FM1→FM2→FMA→FM1... when the button is pressed each time.

2. AM Selection Button

Turns to AM mode, and toggles AM and AMA when the button is pressed each time.

3. TA Selection Button

In FM, CD, AUX mode, turns on/off the reception of TA channels of RDS.

4. CD/AUX Selection Button

If there is a cd in the CDP DECK it turns to CD mode, and if a device is connected to AUX then it toggles.

CD→AUX→CD... when the button is pressed each time.(It will not turn to AUX if the auxiliary device is not connected.)

5. Automatic Channel Selection Button

- When the [SEEK ∨] button is pressed, it reduces the band frequency by 50khz to automatically select channel. Stops at the previous frequency if no channel is found.
- When the [SEEK ^] button is pressed, it increases the band frequency by 50khz to automatically select channel. Stops at the previous frequency if no channel is found.

6. Power ON/OFF & Volume Control Button

- Turns on/off the set when the IGNITION SWITCH is on ACC or ON. If the button is turned to the right, it increases the volume and left, decreases the volume.
- In AUX mode, the volume and tone (BASS, MID, TRE) are adjusted in a separate way.
If you pull out AUX from a jack and insert it again, then only volume goes back to 10-step.

7. AUTO STORE Button

- When you press the [AST] button, the mode changes to 'Auto store Band' and it saves the result.
(FM1 or FM2 changes to FMA, AM changes to AMA.)
- When the button is pressed, it automatically selects and saves channels with high reception rate to PRESET buttons (1~6) and plays the channel saved in PRESET1.
If no channel is saved after AST, it will play the previous channel.

8. Screen ON/ OFF Button

Turns off/on the displayed data and light on LCD.

The screen and light will be turned on by pressing any button except DARK button when the screen is turned off.

9. Information Display Button

Displays the information of the channel currently played by RDS.

10. SET UP Button

Press this button to turn to the SOUND, RDS option, clock setting, time display, SCROLL, SDVC, temperature display and adjustment mode.

If no action is taken for 5 seconds after pressing the button, it will return to the play mode. (After entering SET UP mode, move between items using the left, right and PUSH functions of the TUNE button.)

The set up item changes from AUDIO → RDS → CLOCK → TIME → SCROLL → SDVC → TEMP → AUDIO...

The manual setting is a default for radio time but if customer wants, the time received from RDS station can be set for radio time. In this case, the RDS time, which is effected by the situation of RDS station, can be different with actual time.

*** TO SETUP TIME UPDATE**

1. Press SETUP button.
2. Select RDS menu by rotating/pressing TUNE knob.
3. Select TIME menu by rotating/pressing TUNE knob.
4. Select Auto or Manual by rotating/pressing TUNE knob.
5. Press SETUP button to exit SETUP mode.

11. TUNE/ENTER Button

Turn this button clockwise by one notch to increase frequency by 0.05Mhz from current frequency.

Turn this button counterclockwise by one notch to decrease frequency by 0.05Mhz from current frequency.

Press this button whilst holding SET UP button to activate / inactivate the item to. Select SET UP item using left and right function of the Tune button.

12. PTY(FLDR) Button

- Moves [PTY √] button when searching PTY in RDS Broadcasting Program Type selection.
- Moves [PTY ^] button when searching PTY in RDS Broadcasting Program Type selection.

13. Preset Button

Push [1]~[6] buttons less than 0.8 second to play the channel saved in each button.

Push preset button for 0.8 second or longer to save current channel to the respective button with a beep.

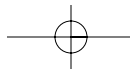

Features of your vehicle

CD (PA760R) (IF EQUIPPED)



1. CD loading slot
2. CD indicator
3. CD Eject Button
4. LOAD Button
5. AUX Selection Button
6. Automatic Track Selection Button
7. INFO Button
8. TUNE/ENTER Button
9. REPEAT Button
10. RANDOM Play Button
11. DISC Selection Button
12. SCAN Play Button

A-300FDE

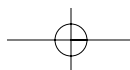

1. CD loading slot

Please face printed side upward and gently push in. When the ignition switch is on ACC or ON and power is off, power is automatically turned on if the CD is loaded. This CDP supports both 8cm and 12 cm CDs. But if VCD, Data CD, MP3 CD are loaded, "Er-6" message will appear and CD will be ejected.

2. CD Indicator

When car ignition switch is ACC or ON and if the CD is loaded, this indicator is lighted. If the CD is ejected the light is turned off.

3. CD eject Button

Push  button to eject the CD during CD playback. This button is enabled when ignition switch is off.

4. CD LOAD Button

Push [LOAD] button to load CDs to available CDC deck (from 1~6). Push [LOAD] button for more than 2 seconds to load into all available decks.





The last CD will play. 10 seconds idle status will disable loading process.

5. AUX Selection Button

If the auxiliary device is connected, it turns to AUX MODE to play the sound from the auxiliary player.

If no auxiliary device is connected, it displays ""NO CONNECT"" for 3 seconds and returns to the previous mode.

6. Automatic Track Selection Button

- Push [SEEK ] button for less than 0.8 second to play from the beginning of current song.
- Push [SEEK ] button for less than 0.8 second and press again within 1 second to play the previous song.
- Push [SEEK ] button for 0.8 second or longer to initiate reverse direction high speed sound search of current song.
- Push [SEEK ] button for less than 0.8 second to play the next song.
- Push [SEEK ] button for 0.8 second or longer to initiate high speed sound search of current song.

7. INFO Button

Displays the information of the current CD TRACK in the order of DISC TITLE→DISC ARTIST→TRACK TITLE→TRACK ARTIST→TOTAL TRACK→ Play Screen→DISC TITLE→....(not displayed if the information is not available on the DISC.)

8. TUNE/ENTER Button

Turn this button clockwise to display songs after current song.

Also, turn this button counterclockwise to display songs before current song.

To listen to the displayed song, press the button to skip to the song and play.

9. REPEAT Button

Repeats current song when the button is pressed for less than 0.8 second.

Repeats the entire DISC when the button is pressed for 0.8 second or longer.

10. RANDOM Play Button

Turns on/off the randomization of the play list of files in the currently played DISC.

To cancel the mode, press the key once again.

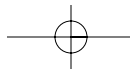

Features of your vehicle

11. DISC Selection Button

- [DISC ∨] Change Button
Changes disc to the previous disc.
- [DISC ^] Change Button
Changes disc to the next disc.

12. SCAN Play Button

Plays first 10 seconds of each song in the DISC.

To cancel the mode, press the key once again.

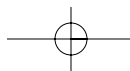
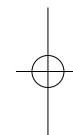
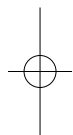

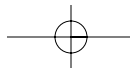

Features of your vehicle

USING USB (PA760R) (IF EQUIPPED)



1. AUX Selection Button
2. Track moving Button
3. INFO Selection Button
4. Folder moving Button
5. TUNE/ENTER Button
6. RANDOM Playback Button
7. REPEAT Selection Button
8. SCAN Selection Button

A-300FDE

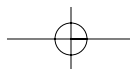

Features of your vehicle

In case USB is connected to the multiple terminal inside the console on the left hand side of the driver's seat. When USB is connected, the 'USB' icon will be displayed on the top right corner of the display screen.

1. AUX Selection Button

If USB is connected, it switches to the USB mode from the CD mode to play the song files stored in the USB.

If there are no CD and USB mode from the Radio mode, it displays 'NO MEDIA'.

2. Track Moving Button

- Press the [SEEK √] button for less than 0.8 second to play from the beginning of the song currently played. Press the button for less than 0.8 second and press it again within 1 second to move to and play the previous track. Press the button for 0.8 second or longer to play the song in reverse direction in fast speed.
- Press the [SEEK ^] button for less than 0.8 second to move to the next track. Press the button for 0.8 second or longer to play the song in forward direction in fast speed.

3. INFO Button

Displays the information of the file currently played in the order of FILE NAME → TITLE → ARTIST → ALBUM → FOLDER → TOTAL FILE → FILE NAME → ... (Displays no information if the file has no song information.)

4. Folder moving Button

- Moves [FLDR √] button child folder of the current folder and displays the first song in the folder. Press TUNE/ENTER button to move to the folder displayed. It will play the first song in the folder.
- Moves [FLDR ^] button parent folder and displays the first song in the folder. Press TUNE/ENTER button to move to the folder displayed. It will play the first song in the folder.

5. TUNE/ENTER Button

Turn this button clockwise to display the songs next to the currently played song. Turn the button counterclockwise to display the songs before the currently played song. Press the button to skip to and play the selected song.

6. RANDOM Playback Button

Press the button for less than 0.8 second to start or stop the random playback of the songs in the current folder.

Press the button for more than 0.8 second to randomly play the entire songs in the USB device.

Press the button again to cancel the mode.

7. REPEAT Button

Press the button for less than 0.8 second to repeat the song currently played.

Press the button for more than 0.8 second to repeat the entire songs in the USB device.

8. SCAN Button

Plays 10 seconds of each song in the USB device.

Press the button once again to cancel scanning.

 **CAUTION - Using USB device**

- *To use an external USB device, make sure the device is not mounted when starting up the vehicle and mount the device after starting up.*
- *If you start the vehicle when the USB device is mounted, it may damage the USB device. (USB is not ESA)*
- *If the vehicle is started up or turned off whilst the external USB device is connected, the external USB device may not work.*
- *It may not play inauthentic MP3 or WMA files.*
 - 1) *It can only play MP3 files with the compression rate between 8Kbps~320Kbps.*
 - 2) *It can only play WMA music files with the compression rate between 8Kbps~320Kbps.*
- *Take cautions for static electricity when mounting or dismounting the external USB device.*
- *An encoded MP3 PLAYER is not recognizable.*

(Continued)

(Continued)

- *Depending on the condition of the external USB device, the connected external USB device can be unrecognizable.*
- *When the formatted byte/sector setting of External USB devices is not either 512BYTE or 2048BYTE, then the device will not be recognized.*
- *Use only a USB device formatted to FAT 12/16/32.*
- *USB devices without USB IF authentication may not be recognizable.*
- *Make sure the USB connection terminal does not come in contact with a human body or any object.*
- *If you repeat mounting or dismounting USB device in a short period of time, it may break the device.*
- *You might hear a strange noise when mounting or dismounting a USB device.*

(Continued)

(Continued)

- *If you dismount the external USB device during playback in USB mode, the external USB device can be damaged or malfunction. Therefore, mount the external USB device when the engine is turned off or in another mode.*
- *Depending on the type and capacity of the external USB device or the type of the files stored in the device, there is a difference in the time taken for recognition of the device, but this is not an indicator of trouble and you only have to wait.*
- *Do not use the USB device for other purposes than playing music files.*
- *Use of USB accessories such as recharger or heater using USB I/F may lower performance or cause trouble.*
- *If you use devices such as a USB hub you purchased separately, the vehicle's audio system may not recognize the USB device. Connect the USB device directly to the multimedia terminal of the vehicle.*

(Continued)

Features of your vehicle

(Continued)

- *If USB device is divided by logical drives, only the music files on the highest-priority drive are recognized by car audio.*
- *Devices such as MP3 Player/Mobile phone/Digital camera those are not recognizable by standard USB I/F can be unrecognizable.*
- *USB devices other than standardized goods (METAL COVER TYPE USB) can be unrecognizable.*
- *USB flash memory reader (such as CF, SD, microSD, etc.) or external-HDD type devices can be unrecognizable.*
- *Music files protected by DRM (DIGITAL RIGHTS MANAGEMENT) are not recognizable.*
- *The data in the USB memory may be lost whilst using this AUDIO. It is recommended to back up important data on a personal.*

(Continued)

(Continued)

- *Please avoid using USB memory products which can be used as key chains or mobile phone accessories as they could cause damage to the USB jack. Please make certain only to use plug type connector products as shown below.*



Features of your vehicle

RUNNING iPod (PA760R) (IF EQUIPPED)



1. iPod Selection Button
2. Track moving Button
3. INFO Selection Button
4. Category Selection Button
5. TUNE/ENTER Button
6. RANDOM Playback Button
7. REPEAT Selection Button

* iPod is a trademark of Apple Inc.

A-300FDE

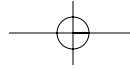

Features of your vehicle

In case the iPod exclusive cable is connected to the multiple terminal inside the console on the left hand side of the driver's seat. When the iPod is connected, the 'iPod' icon will be displayed on the top right corner of the display screen.

1. iPod Selection Button

If iPod is connected, it switches to the iPod mode from the CD mode to play the song files stored in the iPod.

If there are no CD and AUX mode from the Radio mode, it displays 'NO MEDIA'.

2. Track Moving Button

- Press the [SEEK ∨] button for less than 0.8 second to play from the beginning of the song currently played. Press the button for less than 0.8 second and press it again within 1 second to move to and play the previous track. Press the button for 0.8 second or longer to play the song in reverse direction in fast speed.

- Press the [SEEK ∧] button for less than 0.8 second to move to the next track. Press the button for 0.8 second or longer to play the song in forward direction in fast speed.

3. INFO Button

Displays the information of the file currently played in the order of FILE NAME → TITLE → ARTIST → ALBUM → FILE NAME → ...

(Displays no information if the file has no song information.)

4. Category Selection Button

Moves to the upper category from currently played category of the iPod.

To move to (play) the category (song) displayed, press TUNE/ENTER button.

You will be able to search through the lower category of the selected category.

The order of iPod's category is SONG, ALBUMS, ARTISTS, GENRES, and iPod.

5. TUNE/ENTER Button

When you turn the button clockwise, it will display the songs (category) next to the song currently played (category in the same level).

Also, when you turn the button counter-clockwise, it will display the songs (category) before the song currently played (category in the same level).

If you want to listen to the song displayed in the song category, press the button, then it will skip to the selected song and play.

6. RANDOM Playback Button

Press the button for less than 0.8 second to activate or deactivate the random playback of the songs within the current category.

Press the button for longer than 0.8 second to randomly play all songs in the entire album of the iPod.

Press the button once again to cancel the mode.

7. REPEAT Button

Repeats the song currently played.

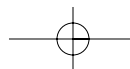
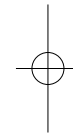
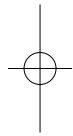

*** NOTICE - Using iPod device**

- Some iPod models might not support the communication protocol and the files will not be played. (iPod models supported: Mini, 4G, Photo, Nano, 5G)
- The order of search or playback of songs in the iPod can be different from the order searched in the audio system.
- If the iPod crashes due to its own trouble, reset the iPod. (Reset: Refer to iPod manual)
- An iPod may not operate normally on low battery.

⚠ CAUTION - Using iPod device

- *You need the power cable exclusive for an iPod in order to operate an iPod with the buttons on the audio system. The PC cable provided by Apple may cause a malfunction and do not use it for vehicle use.*
- *When connecting the device with an iPod cable, push in the jack fully to not to interfere with communication.*
- *When adjusting the sound effects of an iPod and the audio system, the sound effects of both devices will overlap and might reduce or distort the quality of the sound.*
- *Deactivate (turn off) the equalizer function of an iPod when adjusting the audio system's volume, and turn off the equalizer of the audio system when using the equalizer of an iPod.*

(Continued)

(Continued)

- *When the iPod cable is connected, the system can be switched to the AUX mode even without the iPod device and can cause noise. Disconnect the iPod cable when you are not using the iPod device.*
- *When the iPod is not used for the audio system, the iPod cable has to be separate from iPod devices. Origin display of iPod may not be displayed.*

Before driving / 5-3
Key positions / 5-4
Starting the engine / 5-5
Manual transaxle / 5-8
Automatic transaxle / 5-11
Brake system / 5-17
Cruise control system / 5-27
Economical operation / 5-31
Special driving conditions / 5-33
Winter driving / 5-37
Trailer towing / 5-41

Driving your vehicle

5

Vehicle weight / 5-49

E010000AFD-EA

WARNING - ENGINE EXHAUST CAN BE DANGEROUS!

Engine exhaust fumes can be extremely dangerous. If, at any time, you smell exhaust fumes inside the vehicle, open the windows immediately.

- **Do not inhale exhaust fumes.**

Exhaust fumes contain carbon monoxide, a colourless, odourless gas that can cause unconsciousness and death by asphyxiation.

- **Be sure the exhaust system does not leak.**

The exhaust system should be checked whenever the vehicle is raised to change the oil or for any other purpose. If you hear a change in the sound of the exhaust or if you drive over something that strikes the underneath side of the car, have the exhaust system checked as soon as possible by an authorised HYUNDAI dealer.

- **Do not run the engine in an enclosed area.**

Letting the engine idle in your garage, even with the garage door open, is a hazardous practice. Never run the engine in your garage any longer than it takes to start the engine and back the car out.

- **Avoid idling the engine for prolonged periods with people inside the car.**

If it is necessary to idle the engine for a prolonged period with people inside the car, be sure to do so only in an open area with the air intake set at "Fresh" and fan operating at one of the higher speeds so fresh air is drawn into the interior.

If you must drive with the tailgate open because you are carrying objects that make this necessary:

1. Close all windows.
2. Open side vents.
3. Set the air intake control at "Fresh", the air flow control at "Floor" or "Face" and the fan at one of the higher speeds.

To assure proper operation of the ventilation system, be sure the ventilation air intakes located just in front of the windshield are kept clear of snow, ice, leaves or other obstructions.

BEFORE DRIVING

E020100AUN-EA

Before entering vehicle

- Be sure that all windows, outside mirror(s), and outside lights are clean.
- Check the condition of the tyres.
- Check under the vehicle for any sign of leaks.
- Be sure there are no obstacles behind you if you intend to back up.

E020200AUN

Necessary inspections

Fluid levels, such as engine oil, engine coolant, brake fluid, and washer fluid should be checked on a regular basis, with the exact interval depending on the fluid. Further details are provided in Section 7, "Maintenance".

E020300AUN-EA

Before starting

- Close and lock all doors.
- Position the seat so that all controls are easily reached.
- Adjust the inside and outside rearview mirrors.

- Be sure that all lights work.
 - Check all gauges.
 - Check the operation of warning lights when the ignition switch is turned to the ON position.
 - Release the hand brake and make sure the brake warning light goes out.
- For safe operation, be sure you are familiar with your vehicle and its equipment.

WARNING

All passengers must be properly belted whenever the vehicle is moving. Refer to "Seat belts" in section 3 for more information on their proper use.

WARNING

Always check the surrounding areas near your vehicle for people, especially children, before putting a car into "Drive" or "Reverse".

WARNING - Driving under the influence of alcohol or drugs

Drinking and driving is dangerous. Drunk driving is the number one contributor to the highway death toll each year. Even a small amount of alcohol will affect your reflexes, perceptions and judgement. Driving while under the influence of drugs is as dangerous or more dangerous than driving drunk.

You are much more likely to have a serious accident if you drink or take drugs and drive.

If you are drinking or taking drugs, don't drive. Do not ride with a driver who has been drinking or taking drugs. Choose a designated driver or call a cab.

WARNING

When you intend to park or stop the vehicle with the engine on, be careful not to depress the accelerator pedal for a long period of time. It may overheat the engine or exhaust system and cause fire.

KEY POSITIONS



E030100AFD

Illuminated ignition switch (if equipped)

Whenever a front door is opened, the ignition switch will be illuminated for your convenience, provided the ignition switch is not in the ON position. The light will go off immediately when the ignition switch is turned on or go off after about 30 seconds when the door is closed.



Ignition switch position

E030201AUN

LOCK

The steering wheel locks to protect against theft. The ignition key can be removed only in the LOCK position. When turning the ignition switch to the LOCK position, push the key inward at the ACC position and turn the key toward the LOCK position.

E030202AUN-EA

ACC (Accessory)

The steering wheel is unlocked and electrical accessories are operative.

*** NOTICE**

If difficulty is experienced turning the ignition switch to the ACC position, turn the key while turning the steering wheel right and left to release the tension.

E030203AUN

ON

The warning lights can be checked before the engine is started. This is the normal running position after the engine is started.

Do not leave the ignition switch ON if the engine is not running to prevent battery discharge.

E030204AUN-EA

START

Turn the ignition key to the START position to start the engine. The engine will crank until you release the key; then it returns to the ON position. The brake warning lamp can be checked in this position.

⚠ WARNING - Ignition key

- Never turn the ignition switch to LOCK or ACC while the vehicle is moving. This would result in loss of directional control and braking function, which could cause an accident.
- The anti-theft steering column lock is not a substitute for the hand brake. Before leaving the driver's seat, always make sure the shift lever is engaged in P (Park) for the automatic transaxle and set the hand brake fully and shut the engine off. Unexpected and sudden vehicle movement may occur if these precautions are not taken.
- Never reach for the ignition switch, or any other controls through the steering wheel while the vehicle is in motion. The presence of your hand or arm in this area could cause a loss of vehicle control, an accident and serious bodily injury or death.
- Do not place any movable objects around the driver's seat as they may move while driving, interfere with the driver and lead to an accident.

STARTING THE ENGINE

E040000AUN

⚠ WARNING

Always wear appropriate shoes when operating your vehicle. Unsuitable shoes (high heels, ski boots, etc.) may interfere with your ability to use the brake and accelerator pedal, and the clutch (if equipped).

E040100AUN-EA

Starting the petrol engine

1. Make sure the hand brake is applied.
2. **Manual Transaxle** - Depress the clutch pedal fully and shift the transaxle into Neutral. Keep the clutch pedal and brake pedal depressed while turning the ignition switch to the start position.

Automatic Transaxle - Place the transaxle shift lever in P (Park). Depress the brake pedal fully.

You can also start the engine when the shift lever is in the N (Neutral) position.

3. Turn the ignition switch to START and hold it there until the engine starts (a maximum of 10 seconds), then release the key.
4. In extremely cold weather (below -18°C / 0°F) or after the vehicle has not been operated for several days, let the engine warm up without depressing the accelerator.

*Whether the engine is cold or warm, it should be started **without depressing the accelerator**.*

⚠ CAUTION

If the engine stalls while you are in motion, do not attempt to move the shift lever to the P (Park) position. If traffic and road conditions permit, you may put the shift lever in the N (Neutral) position while the vehicle is still moving and turn the ignition switch to the START position in an attempt to restart the engine.

⚠ CAUTION

Do not crank the engine for more than 10 seconds. If the engine stalls or fails to start, wait 5 to 10 seconds before cranking the engine again. Improper use of the starter motor may cause damage to it.

E040101AUN-EA

Starting the diesel engine

To start the diesel engine when the engine is cold, it has to be pre-heated before starting the engine and then have to be warmed up before starting to drive.

1. Make sure the hand brake is applied.
2. **Manual Transaxle** - Depress the clutch pedal fully and shift the transaxle into Neutral. Keep the clutch pedal and brake pedal depressed while turning the ignition switch to the start position.

Automatic Transaxle - Place the transaxle shift lever in P(park). Depress the brake pedal fully.

You can also start the engine when the shift lever is in the N(neutral) position.

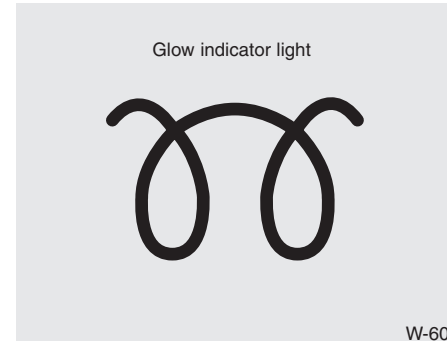

3. Turn the ignition switch to the ON position to pre-heat the engine. Then the glow indicator light will illuminate.
4. If the glow indicator light goes out, turn the ignition switch to the START position and hold it there until the engine starts (a maximum of 10 seconds), then release the key.

*** NOTICE**

If the engine is not started within 10 seconds after the preheating is completed, turn the ignition key once more to the LOCK position during 10 seconds, and then to the ON position, in order to pre-heat again.

Starting and stopping the engine for turbocharger intercooler

1. Do not race or accelerate the engine immediately after starting.

If the engine is cold, idle for several seconds. This allows sufficient lubrication to the turbo charger unit.

2. After high speed or extended driving, requiring a heavy engine load, idle the engine about 1 minute before turning it off.

This idle time will allow the turbocharger to cool prior to shutting the engine off.



CAUTION

Do not turn the engine off immediately after it has been subjected to a heavy load. Doing so may cause severe damage to the engine or turbocharger unit.

MANUAL TRANSAXLE (IF EQUIPPED)

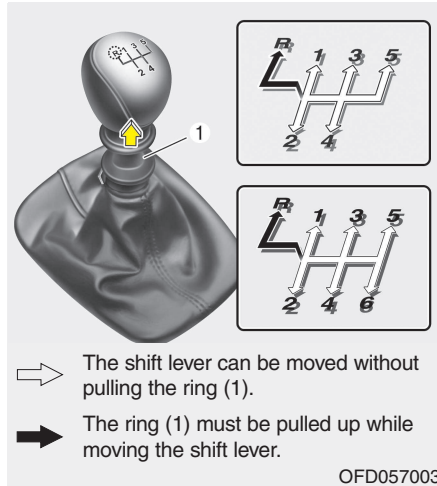

OFD057003

E050000AUN

E050100AUN-EA

Manual transaxle operation

The manual transaxle has 5 (or 6) forward gears.

This shift pattern is imprinted on the shift knob. The transaxle is fully synchronised in all forward gears so shifting to either a higher or a lower gear is easily accomplished.

Press the clutch pedal down fully while shifting, then release it slowly.

If your vehicle is equipped with an ignition lock switch, the engine will not start when starting the engine without depressing the clutch pedal. (if equipped)

The gearshift lever must be returned to the neutral position before shifting into R (Reverse). The ring located immediately below the shift knob must be pulled upward while moving the shift lever to the R position.

Make sure the vehicle is completely stopped before shifting into R (Reverse).

Never operate the engine with the tachometer (rpm) in the red zone.

CAUTION

- *When downshifting from fifth gear to fourth gear, caution should be taken not to inadvertently press the gear shift lever sideways in such a manner that second gear is engaged. Such a drastic downshift may cause the engine speed to increase to the point that the tachometer will enter the red-zone. Such over-revving of the engine may possibly cause engine damage.*
- *Do not downshift more than 2 gears or downshift the gear when the engine is running at high speed (5,000 RPM or higher). Doing so may damage the engine.*

- During cold weather, shifting may be difficult until the transaxle lubricant has warmed up. This is normal and not harmful to the transaxle.
- If you've come to a complete stop and it's hard to shift into 1st or R(Reverse), put the shift lever in N(Neutral) position and release the clutch. Press the clutch pedal back down, and then shift into 1st or R(Reverse) gear position.

CAUTION

- *To avoid premature clutch wear and damage, do not drive with your foot resting on the clutch pedal. Also, don't use the clutch to hold the vehicle stopped on an uphill grade, while waiting for a traffic light, etc.*
- *Do not use the shift lever as a handrest during driving, as this can result in premature wear of the transaxle shift forks.*

WARNING

- **Before leaving the driver's seat, always set the hand brake fully and shut the engine off. Then make sure the transaxle is shifted into 1st gear when the vehicle is parked on a level or uphill grade, and shifted into R (Reverse) on a downhill grade. Unexpected and sudden vehicle movement can occur if these precautions are not followed in the order identified.**
- **If your vehicle has a manual transaxle not equipped with a ignition lock switch, it may move and cause a serious accident when starting the engine without depressing the clutch pedal while the parking brake is released and the shift lever not in the N(Neutral) position.**

E050101AUN-EA

Using the clutch

The clutch should be pressed all the way to the floor before shifting, then released slowly. The clutch pedal should always be fully released while driving. Do not rest your foot on the clutch pedal while driving. This can cause unnecessary wear. Do not partially engage the clutch to hold the car on an incline. This causes unnecessary wear. Use the foot brake or hand brake to hold the car on an incline. Do not operate the clutch pedal rapidly and repeatedly.

E050102AUN-EA

Downshifting

When you must slow down in heavy traffic or while driving up steep hills, downshift before the engine starts to labour. Downshifting reduces the chance of stalling and gives better acceleration when you again need to increase your speed. When the vehicle is traveling down steep hills, downshifting helps maintain safe speed and prolongs brake life.

E050200AUN

Good driving practices



- Never take the car out of gear and coast down a hill. This is extremely hazardous. Always leave the car in gear.
- Don't "ride" the brakes. This can cause them to overheat and malfunction. Instead, when you are driving down a long hill, slow down and shift to a lower gear. When you do this, engine braking will help slow the car.
- Slow down before shifting to a lower gear. This will help avoid over-revving the engine, which can cause damage.
- Slow down when you encounter cross winds. This gives you much better control of your car.
- Be sure the car is completely stopped before you attempt to shift into reverse. The transaxle can be damaged if you do not. To shift into reverse, depress the clutch, move the shift lever to neutral, wait three seconds, then shift to the reverse position.
- Exercise extreme caution when driving on a slippery surface. Be especially careful when braking, accelerating or shifting gears. On a slippery surface, an abrupt change in vehicle speed can cause the drive wheels to lose traction and the vehicle to go out of control.

WARNING

- **Always buckle-up! In a collision, an unbelted occupant is significantly more likely to be seriously injured or killed than a properly belted occupant.**
- **Avoid high speeds when cornering or turning.**
- **Do not make quick steering wheel movements, such as sharp lane changes or fast, sharp turns.**
- **The risk of rollover is greatly increased if you lose control of your vehicle at highway speeds.**
- **Loss of control often occurs if two or more wheels drop off the roadway and the driver oversteers to reenter the roadway.**
- **In the event your vehicle leaves the roadway, do not steer sharply. Instead, slow down before pulling back into the travel lanes.**
- **Never exceed posted speed limits.**

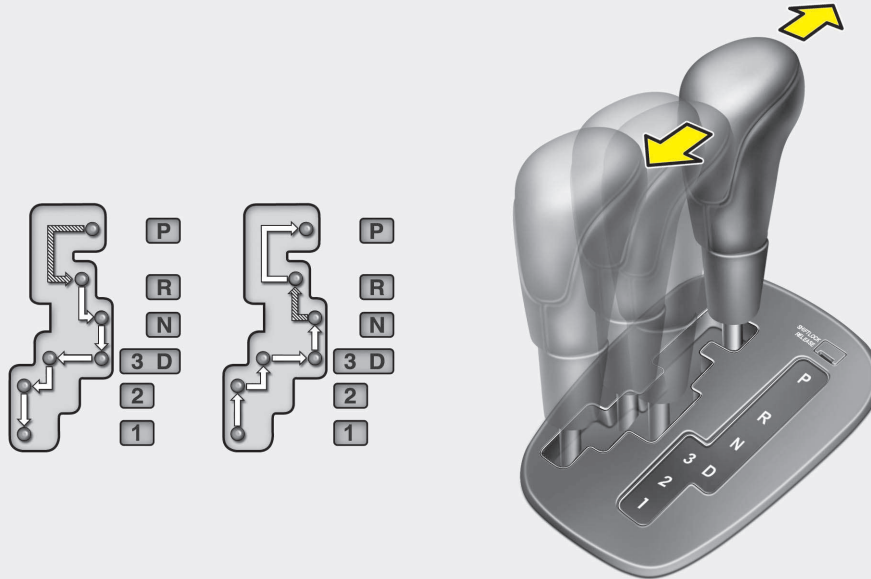
AUTOMATIC TRANSAXLE (IF EQUIPPED)



-  Depress the brake pedal when shifting, if your vehicle is equipped shift lock system.
-  The shift lever can be moved freely.

E060100AFD-EA

Automatic transaxle operation

The highly efficient automatic transaxle has 4 forward gears and one reverse gear. The individual gears are selected automatically, depending on the position of the shift lever.

All normal forward driving is done with the shift lever in the D (Drive) position.

To move the shift lever from the P (Park) position, the brake pedal must be depressed with the ignition switch ON.

* NOTICE

The first few shifts on a new vehicle, if the battery has been disconnected, may be somewhat abrupt. This is a normal condition, and the shifting sequence will adjust after shifts are cycled a few times by the TCM (Transaxle Control Module) or PCM (Powertrain Control Module).

For smooth operation, depress the brake pedal when shifting from N (Neutral) to a forward or reverse gear.

WARNING - Automatic transaxle

- **Always check the surrounding areas near your vehicle for people, especially children, before putting a car into D (Drive) or R (Reverse).**
- **Before leaving the driver's seat, always make sure the shift lever is in the P (Park) position; then set the hand brake fully and shut the engine off. Unexpected and sudden vehicle movement can occur if these precautions are not followed in the order identified.**

CAUTION

- **To avoid damage to your transaxle, do not accelerate the engine in R (Reverse) or any forward gear position with the brakes on.**
- **When stopped on an upgrade, do not hold the vehicle stationary with engine power. Use the service brake or the hand brake.**
- **Do not shift from N (Neutral) or P (Park) into D (Drive), or R (Reverse) when the engine is above idle speed.**

E060101AFD-EA

Transaxle ranges

The indicator lights in the instrument cluster displays the shift lever position when the ignition switch is in the ON position.

P (Park)

Always come to a complete stop before shifting into P (Park). This position locks the transaxle and prevents the front wheels from rotating.

 **WARNING**

- Shifting into P (Park) while the vehicle is in motion will cause the drive wheels to lock which will cause you to lose control of the vehicle.
- Do not use the P (Park) position in place of the hand brake. Always make sure the shift lever is latched in the P (Park) position and set the hand brake fully.
- Before leaving the driver's seat, always make sure the shift lever is in the P (Park) position. Set the hand brake fully, shut the engine off and take the key with you. Unexpected and sudden vehicle movement can occur if you do not follow these precautions in the order specified.
- Never leave a child unattended in a vehicle.

 **CAUTION**

The transaxle may be damaged if you shift into P (Park) while the vehicle is in motion.

R (Reverse)

Use this position to drive the vehicle backward.

 **CAUTION**

Always come to a complete stop before shifting into or out of R (Reverse); you may damage the transaxle if you shift into R while the vehicle is in motion, except as explained in "Rocking the Vehicle", in this manual.

N (Neutral)

The wheels and transaxle are not locked. The vehicle will roll freely even on the slightest incline unless the hand brake or service brakes are applied.

D (Drive)

This is the normal forward driving position. The transaxle will automatically shift through a 4-gear sequence, providing the best fuel economy and power.

Bring the car to a complete stop before shifting the selector to "D" position.

For extra power when passing another vehicle or climbing grades, depress the accelerator fully, at which time the transaxle will automatically downshift to the next lower gear.

3 (Third gear)

Use for towing a trailer during hill climbing or to use engine braking downhill.

"3" automatically shifts between 1st, 2nd and 3rd gears. This means that no shift-up to 4th gear is performed. However, the shift-up to 4th gear is done when the car speed exceeds a certain value to prevent the engine from over-revving. Manually move the selector to "D" when returning to normal driving condition.

2 (Second gear)

Use for driving on a slippery road, hill climbing or engine braking downhill. "2" automatically shifts between first and second gears.

This means that no shift-up to 3rd gear is performed. However, the shift-up to third gear is done when the car speed exceeds a certain value to prevent the engine from over-revving. Manually move the selector to "D" returning to normal driving condition.

1 (First gear)

Use for driving up a very steep grade or for engine braking when descending steep hills. When downshifting to "1", the transaxle will temporarily remain in second gear until the vehicle has slowed enough for low gear to engage. Do not exceed 50 km/h (30 mph) in low gear.

"1" shifts to 1st gear only. However, shift up to 2nd is performed when the car exceeds a certain speed and, as speed increases, the transaxle will shift up to 3rd gear to prevent over-revving the engine.

* NOTICE

- For smooth and safe operation, depress the brake pedal when shifting from "N" (Neutral) position or "P" (Park) position to a forward or "R" (Reverse) gear.
- Fully depress the brake pedal in order to move the shift lever from the "P" (Park) position to any of the other positions.
- It is always possible to shift from "R", "N", "D", "3", "2", "1" position to "P" position. The vehicle must be fully stopped to avoid transaxle damage.

CAUTION

- **Shift into "R", "D" and "P" position only when the vehicle has completely stopped.**
- **Do not accelerate the engine in reverse or any of the forward positions with the brakes applied.**
- **Always apply the footbrake when shifting from "P" or "N", to "R", "D", "3", "2" or "1" position.**
- **Check the automatic transaxle fluid level regularly, and add fluid as necessary.**
See the maintenance schedule for the proper fluid recommendation.

E060102AFD-EA

Shift lock system (if equipped)

For your safety, the automatic transaxle has a shift lock system which prevents shifting the transaxle out of P (Park) unless the brake pedal is depressed.

To shift the transaxle out of P (Park):

1. Depress and hold the brake pedal.
2. Start the engine or turn the ignition switch to the ON position.
3. Move the shift lever.

If the brake pedal is repeatedly depressed and released with the shift lever in the P (Park) position, a chattering noise near the shift lever may be heard. This is a normal condition.

⚠ WARNING

Always fully depress the brake pedal before and while shifting out of the P (Park) position into another position to avoid inadvertent motion of the vehicle which could injure persons in or around the car.

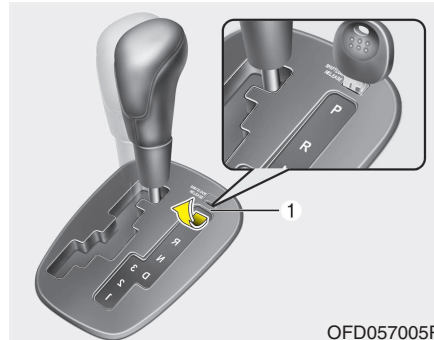
**Shift-lock override**

If the shift lever cannot be moved from the P (Park) position with the brake pedal depressed, continue depressing the brake, then do the following:

1. Carefully remove the cap (1) covering the shift-lock override access hole.
2. Insert a screwdriver (or key) into the access hole and press down on the screwdriver (or key).
3. Move the shift lever.
4. Have your vehicle inspected by an authorised HYUNDAI dealer immediately.

E060103AUN

Ignition key interlock system (if equipped)

The ignition key cannot be removed unless the shift lever is in the P (Park) position. If the ignition switch is in any other position, the key cannot be removed.

E060200AFD-EA

Good driving practices

- Never move the gear selector lever from P (Park) or N (Neutral) to any other position with the accelerator pedal depressed.
- Never move the gear selector lever into "P" when the vehicle is in motion.
- Be sure the car is completely stopped before you attempt to shift into R (Reverse) or D (Drive).
- Never take the car out of gear and coast down a hill. This may be extremely hazardous. Always leave the car in gear when moving.
- Do not "ride" the brakes. This can cause them to overheat and malfunction. Instead, when you are driving down a long hill, slow down and shift to a lower gear. When you do this, engine braking will help slow the car.
- Slow down before shifting to a lower gear. Otherwise, the lower gear may not be engaged.
- Always use the hand brake. Do not depend on placing the transaxle in P (Park) to keep the car from moving.
- Exercise extreme caution when driving on a slippery surface. Be especially careful when braking, accelerating or shifting gears. On a slippery surface, an abrupt change in vehicle speed can cause the drive wheels to lose traction and the vehicle to go out of control.

- Optimum vehicle performance and economy is obtained by smoothly depressing and releasing the accelerator pedal.

WARNING

- **Always buckle-up! In a collision, an unbelted occupant is significantly more likely to be seriously injured or killed than a properly belted occupant.**
- **Avoid high speeds when cornering or turning.**
- **Do not make quick steering wheel movements, such as sharp lane changes or fast, sharp turns.**
- **The risk of rollover is greatly increased if you lose control of your vehicle at highway speeds.**
- **Loss of control often occurs if two or more wheels drop off the roadway and the driver oversteers to reenter the roadway.**
- **In the event your vehicle leaves the roadway, do not steer sharply. Instead, slow down before pulling back into the travel lanes.**
- **Never exceed posted speed limits.**

WARNING

If your vehicle becomes stuck in snow, mud, sand, etc., then you may attempt to rock the vehicle free by moving it forward and backward. Do not attempt this procedure if people or objects are anywhere near the vehicle. During the rocking operation the vehicle may suddenly move forward or backward as it becomes unstuck, causing injury or damage to nearby people or objects.

E060203AFD-EA

Moving up a steep grade from a standing start

To move up a steep grade from a standing start, depress the brake pedal, shift the shift lever to D (Drive). Select the appropriate gear depending on load weight and steepness of the grade, and release the hand brake. Depress the accelerator gradually while releasing the service brakes.

BRAKE SYSTEM

E070100AUN

Power brakes

Your vehicle has power-assisted brakes that adjust automatically through normal usage.

In the event that the power-assisted brakes lose power because of a stalled engine or some other reason, you can still stop your vehicle by applying greater force to the brake pedal than you normally would. The stopping distance, however, will be longer.

When the engine is not running, the reserve brake power is partially depleted each time the brake pedal is applied. Do not pump the brake pedal when the power assist has been interrupted.

Pump the brake pedal only when necessary to maintain steering control on slippery surfaces.

WARNING - Brakes

- Do not drive with your foot resting on the brake pedal. This will create abnormal high brake temperatures, excessive brake lining and pad wear, and increased stopping distances.

(Continued)

(Continued)

- When descending a long or steep hill, shift to a lower gear and avoid continuous application of the brakes. Continuous brake application will cause the brakes to overheat and could result in a temporary loss of braking performance.
- Wet brakes may impair the vehicle's ability to safely slow down; the vehicle may also pull to one side when the brakes are applied. Applying the brakes lightly will indicate whether they have been affected in this way. Always test your brakes in this fashion after driving through deep water. To dry the brakes, apply them lightly while maintaining a safe forward speed until brake performance returns to normal.

E070101AUN-EA

In the event of brake failure

If service brakes fail to operate while the vehicle is in motion, you can make an emergency stop with the hand brake. The stopping distance, however, will be much greater than normal.

WARNING - Hand brake

Applying the hand brake while the vehicle is moving at normal speeds can cause a sudden loss of control of the vehicle. If you must use the hand brake to stop the vehicle, use great caution in applying the brake.

E070102AUN-EA

Disc brakes wear indicator

Your vehicle has disc brakes.

When your brake pads are worn and new pads are required, you will hear a high-pitched warning sound from your front or rear brakes (if equipped). You may hear this sound come and go or it may occur whenever you depress the brake pedal.

Please remember that some driving conditions or climates may cause a brake squeal when you first apply (or lightly apply) the brakes. This is normal and does not indicate a problem with your brakes.

⚠ CAUTION

- ***To avoid costly brake repairs, do not continue to drive with worn brake pads.***
- ***Always replace brake pads as complete front or rear axle sets.***

⚠ WARNING - Brake wear

This brake wear warning sound means your vehicle needs service. If you ignore this audible warning, you will eventually lose braking performance, which could lead to a serious accident.

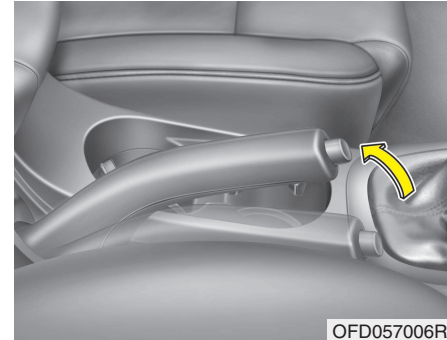

Hand brake

E070201AFD-EA

Applying the hand brake

To engage the hand brake, first apply the foot brake and then without pressing the release button, pull the hand brake lever up as far as possible. In addition it is recommended that when parking the vehicle on a gradient, the shift lever should be positioned in the appropriate low gear on manual transaxle vehicles or in the P (Park) position on automatic transaxle vehicles.

⚠ CAUTION

Driving with the hand brake applied will cause excessive brake pad and brake rotor wear.

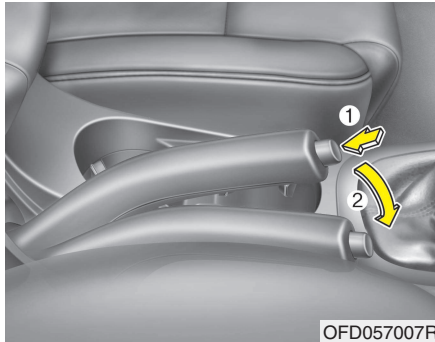

OFD057007R

E070202AFD-EA

Releasing the hand brake

To release the hand brake, first apply the foot brake and pull up the hand brake lever slightly. Secondly depress the release button (1) and lower the hand brake lever (2) while holding the button.

⚠ WARNING

- To prevent unintentional movement when stopped and leaving the vehicle, do not use the gearshift lever in place of the hand brake. Set the hand brake AND make sure the gearshift lever is securely positioned in 1st (First) gear or R (Reverse) for manual transaxle equipped vehicles and in P (Park) for automatic transaxle equipped vehicles.
- Never allow anyone who is unfamiliar with the vehicle to touch the hand brake. If the hand brake is released unintentionally, serious injury may occur.
- All vehicles should always have the hand brake fully engaged when parking to avoid inadvertent movement of the car which can injure occupants or pedestrians.



W-75

Check the brake warning light by turning the ignition switch ON (do not start the engine). This light will be illuminated when the hand brake is applied with the ignition switch in the START or ON position.

Before driving, be sure the hand brake is fully released and the brake warning light is off.

If the brake warning light remains on after the hand brake is released while engine is running, there may be a malfunction in the brake system. Immediate attention is necessary.

If at all possible, cease driving the vehicle immediately. If that is not possible, use extreme caution while operating the vehicle and only continue to drive the vehicle until you can reach a safe location or repair shop.

E070300AFD-EA

Anti-lock brake system (ABS) (if equipped)

WARNING

ABS (or ESP) will not prevent accidents due to improper or dangerous driving manoeuvres. Even though vehicle control is improved during emergency braking, always maintain a safe distance between you and objects ahead. Vehicle speeds should always be reduced during extreme road conditions.

The braking distance for cars equipped with an anti-lock braking system (Electronic Stability Program System) may be longer than for those without it in the following road conditions.

During these conditions the vehicle should be driven at reduced speeds:

- **Rough, gravel or snow-covered roads.**
- **With tyre chains installed.**
- **On roads where the road surface is pitted or has different surface height.**

(Continued)

(Continued)

The safety features of an ABS (or ESP) equipped vehicle should not be tested by high speed driving or cornering. This could endanger the safety of yourself or others.

The ABS continuously senses the speed of the wheels. If the wheels are going to lock, the ABS system repeatedly modulates the hydraulic brake pressure to the wheels.

When you apply your brakes under conditions which may lock the wheels, you may hear a “tik-tik” sound from the brakes, or feel a corresponding sensation in the brake pedal. This is normal and it means your ABS is active.

In order to obtain the maximum efficiency from your ABS in an emergency situation, do not attempt to modulate your brake pressure and do not try to pump your brakes. Press your brake pedal as hard as possible or as hard as the situation warrants and allow the ABS to control the force being delivered to the brakes.

*** NOTICE**

A click sound may be heard in the engine compartment when the vehicle begins to move after the engine is started. These conditions are normal and indicate that the anti-lock brake system is functioning properly.

- Even with the anti-lock brake system, your vehicle still requires sufficient stopping distance. Always maintain a safe distance from the vehicle in front of you.
- Always slow down when cornering. The anti-lock brake system cannot prevent accidents resulting from excessive speeds.
- On loose or uneven road surfaces, operation of the anti-lock brake system may result in a longer stopping distance than for vehicles equipped with a conventional brake system.

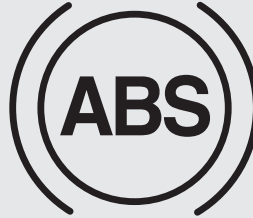

W-78

⚠ CAUTION

- *If the ABS warning light is on and stays on, you may have a problem with the ABS. In this case, however, your regular brakes will work normally.*
- *The ABS warning light will stay on for approximately 3 seconds after the ignition switch is ON. During that time, the ABS will go through self-diagnosis and the light will go off if everything is normal. If the light stays on, you may have a problem with your ABS. Contact an authorised HYUNDAI dealer as soon as possible.*

⚠ CAUTION

- *When you drive on a road having poor traction, such as an icy road, and operate your brakes continuously, the ABS will be active continuously and the ABS warning light may illuminate. Pull your car over to a safe place and stop the engine.*
- *Restart the engine. If the ABS warning light is off, then your ABS system is normal. Otherwise, you may have a problem with the ABS. Contact an authorised HYUNDAI dealer as soon as possible.*

*** NOTICE**

When you jump start your vehicle because of a drained battery, the engine may not run as smoothly and the ABS warning light may turn on at the same time. This happens because of the low battery voltage. It does not mean your ABS is malfunctioning.

- Do not pump your brakes!
- Have the battery recharged before driving the vehicle.



E070500AUN-EA

Electronic stability program (ESP) (If equipped)

The Electronic Stability Program (ESP) system is designed to stabilise the vehicle during cornering manoeuvres. ESP checks where you are steering and where the vehicle is actually going. ESP applies the brakes at individual wheels and intervenes in the engine management system to stabilise the vehicle.

⚠ WARNING

Never drive too fast for the road conditions or too quickly when cornering. Electronic stability program (ESP) will not prevent accidents. Excessive speed in turns, abrupt manoeuvres and aquaplaning on wet surfaces can still result in serious accidents. Only a safe and attentive driver can prevent accidents by avoiding manoeuvres that cause the vehicle to lose traction. Even with ESP installed, always follow all the normal precautions for driving - including driving at safe speeds for the conditions.

The Electronic Stability Program (ESP) system is an electronic system designed to help the driver maintain vehicle control under adverse conditions. It is not a substitute for safe driving practices. Factors including speed, road conditions and driver steering input can all affect whether ESP will be effective in preventing a loss of control. It is still your responsibility to drive and corner at reasonable speeds and to leave a sufficient margin of safety.

When you apply your brakes under conditions which may lock the wheels, you may hear a “tik-tik” sound from the brakes, or feel a corresponding sensation in the brake pedal. This is normal and it means your ESP is active.

*** NOTICE**

A click sound may be heard in the engine compartment when the vehicle begins to move after the engine is started. These conditions are normal and indicate that the Electronic Stability Program System is functioning properly.

E070501AUN-EE

ESP operation

ESP ON condition



- When the ignition is turned ON, ESP and ESP OFF indicator lights illuminate for approximately 3 seconds, then ESP is turned on.
- Press the ESP OFF button for at least half a second after turning the ignition ON to turn ESP off. (ESP OFF indicator will illuminate). To turn the ESP on, press the ESP OFF button (ESP OFF indicator light will go off).
- When starting the engine, you may hear a slight ticking sound. This is the ESP performing an automatic system self-check and does not indicate a problem.

When operating



When the ESP is in operation, ESP indicator light blinks.

- When the Electronic Stability Program is operating properly, you can feel a slight pulsation in the vehicle. This is only the effect of brake control and indicates nothing unusual.
- When moving out of the mud or slippery road, pressing the accelerator pedal may not cause the engine rpm (revolutions per minute) to increase.

E070502AUN-EE

ESP operation off

ESP OFF state



- To cancel ESP operation, press the ESP OFF button (ESP OFF indicator light illuminates).
- If the ignition switch is turned to LOCK position when ESP is off, ESP remains off. Upon restarting the engine, the ESP will automatically turn on again.

- ESP indicator light (blinks)

ESP

- ESP OFF indicator light (comes on)

**ESP
OFF**

E070503BFD-EA

Indicator light

When ignition switch is turned to ON, the indicator light illuminates, then goes off if ESP system is operating normally.

The ESP indicator light blinks whenever ESP is operating.

ESP OFF indicator light comes on when either the ESP is turned off with the button, or ESP fails to operate when turned on.

CAUTION

Driving with varying tyre or wheel sizes may cause the ESP system to malfunction. When replacing tyres, make sure they are the same size as your original tyres.

WARNING

The Electronic Stability Program system is only a driving aid; use precautions for safe driving by slowing down on curved, snowy, or icy roads. Drive slowly and don't attempt to accelerate whenever the ESP indicator light is blinking, or when the road surface is slippery.

*** NOTICE**

After reconnecting or recharging a discharged battery, the ESP OFF indicator may illuminate. In this case, turn the steering wheel 360 degrees to the left and 360 degrees to the right while the ignition switch is in the ON position. Then, restart the engine after the ignition is off. If the ESP OFF indicator does not turn off, have the system checked by an authorised HYUNDAI dealer as soon as possible.

E070504AUN-EE

ESP OFF usage

When driving

- It's a good idea to keep the ESP turned on for daily driving whenever possible.
- To turn ESP off while driving, press the ESP OFF button while driving on a flat road surface.

Never press the ESP OFF button while ESP is operating (ESP indicator light blinks).

If ESP is turned off while ESP is operating, the vehicle may slip out of control.

*** NOTICE**

- When operating the vehicle on a dynamometer, ensure that the ESP is turned off (ESP OFF light illuminated). If the ESP is left on, it may prevent the vehicle speed from increasing, and result in false diagnosis.
- Turning the ESP off does not affect ABS or brake system operation.

⚠ WARNING

Never press the ESP OFF button while ESP is operating.

If the ESP is turned off while ESP is operating, the vehicle may go out of control.

To turn ESP off while driving, press the ESP OFF button while driving on a flat road surface.

E070600AFD-EA

Good braking practices**⚠ WARNING**

- Whenever leaving vehicle or parking, always set the hand brake as far as possible and fully engage the vehicle's transaxle into the park position. Vehicles not fully engaged in park with the hand brake set are at risk for moving inadvertently and injuring yourself or others.

- All vehicles should always have the hand brake fully engaged when parking to avoid inadvertent movement of the car which can injure occupants or pedestrians.

- After being parked, check to be sure the hand brake is not engaged and that the hand brake indicator light is out before driving away.
- Driving through water may get the brakes wet. They can also get wet when the car is washed. Wet brakes can be dangerous! Your car will not stop as quickly if the brakes are wet. Wet brakes may cause the car to pull to one side.

To dry the brakes, apply the brakes lightly until the braking action returns to normal, taking care to keep the car under control at all times. If the braking action does not return to normal, stop as soon as it is safe to do so and call an authorised HYUNDAI dealer for assistance.

- Don't coast down hills with the car out of gear. This is extremely hazardous. Keep the car in gear at all times, use the brakes to slow down, then shift to a lower gear so that engine braking will help you maintain a safe speed.
- Don't "ride" the brake pedal. Resting your foot on the brake pedal while driving can be dangerous because it can result in the brakes overheating and losing their effectiveness. It also increases the wear of the brake components.
- If a tyre goes flat while you are driving, apply the brakes gently and keep the car pointed straight ahead while you slow down. When you are moving slowly enough for it to be safe to do so, pull off the road and stop in a safe place.

Driving your vehicle

- If your car is equipped with an automatic transaxle, don't let your car creep forward. To avoid creeping forward, keep your foot firmly on the brake pedal when the car is stopped.
- Use caution when parking on a hill. Firmly engage the hand brake and place the gear selector lever in P (automatic transaxle) or in first or reverse gear (manual transaxle). If your car is facing downhill, turn the front wheels into the kerb to help keep the car from rolling. If your car is facing uphill, turn the front wheels away from the kerb to help keep the car from rolling. If there is no kerb or if it is required by other conditions to keep the car from rolling, block the wheels.
- Under some conditions your hand brake can freeze in the engaged position. This is most likely to happen when there is an accumulation of snow or ice around or near the rear brakes or if the brakes are wet. If there is a risk that the hand brake may freeze, apply it only temporarily while you put the gear selector lever in P (automatic transaxle) or in first or reverse gear (manual transaxle) and block the rear wheels so the car cannot roll. Then release the hand brake.
- Do not hold the vehicle on the upgrade with the accelerator pedal. This can cause the transaxle to overheat. Always use the brake pedal or hand brake.

CRUISE CONTROL SYSTEM (IF EQUIPPED)

E090000AFD-EA

The cruise control system allows you to program the vehicle to maintain a constant speed without resting your foot on the accelerator pedal.

This system is designed to function above approximately 40 km/h (25 mph).

⚠ WARNING

- If the cruise control is left on, (CRUISE indicator light in the instrument cluster illuminated) the cruise control can be switched on accidentally. Keep the cruise control system off (CRUISE indicator light OFF) when the cruise control is not in use, to avoid inadvertently setting a speed.
- Use the cruise control system only when travelling on open highways in good weather.
- Do not use the cruise control when it may not be safe to keep the car at a constant speed, for instance, driving in heavy or varying traffic, or on slippery (rainy, icy or snow-covered) or winding roads or over 6% up-hill or down-hill roads.

(Continued)

(Continued)

- Pay particular attention to the driving conditions whenever using the cruise control system.
- Be careful when driving downhill using the cruise control system, which may increase the vehicle speed.

⚠ CAUTION

During cruise-speed driving of a manual transaxle vehicle, do not shift into neutral without depressing the clutch pedal, since the engine will be overrevved. If this happens, depress the clutch pedal or release the cruise control ON/OFF switch.

*** NOTICE**

During normal cruise control operation, when the SET switch is activated or reactivated after applying the brakes, the cruise control will energize after approximately 3 seconds. This delay is normal.



E090100AUN

To set cruise control speed:

1. Push the CRUISE ON-OFF button on the steering wheel to turn the system on. The CRUISE indicator light in the instrument cluster will illuminate.
2. Accelerate to the desired speed, which must be more than 40 km/h (25 mph).



3. Push the COAST/SET switch, and release it at the desired speed. The SET indicator light in the instrument cluster will illuminate. Release the accelerator at the same time. The desired speed will automatically be maintained.

On a steep grade, the vehicle may slow down or speed up slightly while going downhill.

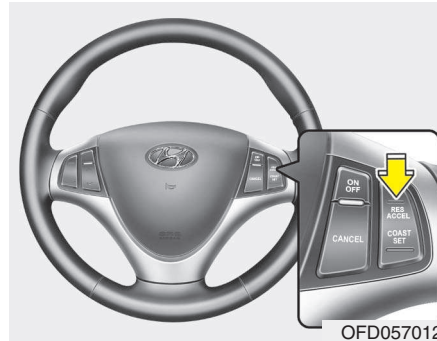

E090200AFD

To increase cruise control set speed:

Follow either of these procedures:

- Push the RES/ACCEL switch and hold it. Your vehicle will accelerate. Release the switch at the speed you want.
- Push the RES/ACCEL switch and release it immediately. The cruising speed will increase by 1.6 km/h (1 mph) each time the RES/ACCEL switch is operated in this manner.



E090300AFD

To decrease the cruising speed:

Follow either of these procedures:

- Push the COAST/SET switch and hold it. Your vehicle will gradually slow down. Release the switch at the speed you want to maintain.
- Push the COAST/SET switch and release it immediately. The cruising speed will decrease by 1.6 km/h (1 mph) each time the COAST/SET switch is operated in this manner.

E090400AUN

To temporarily accelerate with the cruise control on:

If you want to speed up temporarily when the cruise control is on, depress the accelerator pedal. Increased speed will not interfere with cruise control operation or change the set speed.

To return to the set speed, take your foot off the accelerator.

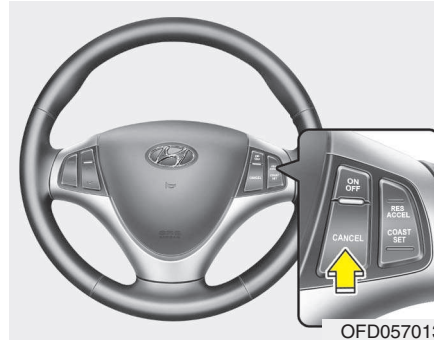

E090500AFD

To cancel cruise control, do one of the following:

- Press the brake pedal.
- Press the clutch pedal with a manual transaxle.
- Shift into N (Neutral) with an automatic transaxle.
- Press the CANCEL switch located on the steering wheel.
- Decrease the vehicle speed lower than the memory speed by 15 km/h (9 mph).
- Decrease the vehicle speed to less than approximately 40 km/h (25 mph).

Each of these actions will cancel cruise control operation (the SET indicator light in the instrument cluster will go off), but it will not turn the system off. If you wish to resume cruise control operation, push the RES/ACCEL switch located on your steering wheel. You will return to your previously preset speed.

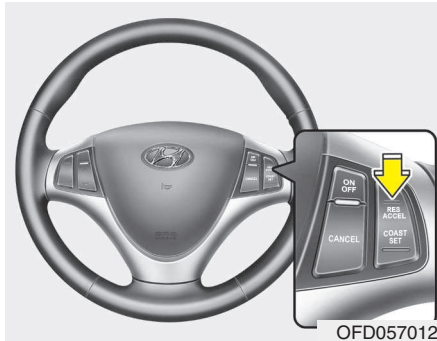

E090700AUN

To turn cruise control off, do one of the following:

- Push the CRUISE ON-OFF button (the CRUISE indicator light in the instrument cluster will go off).
- Turn the ignition off.

Both of these actions cancel cruise control operation. If you want to resume cruise control operation, repeat the steps provided in “To set cruise control speed” on the previous page.

E090600AUN

To resume cruising speed at more than approximately 40 km/h (25 mph):

If any method other than the CRUISE ON-OFF switch was used to cancel cruising speed and the system is still activated, the most recent set speed will automatically resume when the RES/ACCEL switch is pushed.

It will not resume, however, if the vehicle speed has dropped below approximately 40 km/h (25 mph).

ECONOMICAL OPERATION

E100000AFD-EA

Your vehicle's fuel economy depends mainly on your style of driving, where you drive and when you drive.

Each of these factors affects how many kilometers (miles) you can get from a litre (gallon) of fuel. To operate your vehicle as economically as possible, use the following driving suggestions to help save money in both fuel and repairs:

- Drive smoothly. Accelerate at a moderate rate. Don't make "kangaroo" starts or full-throttle shifts and maintain a steady cruising speed. Don't race between stoplights. Try to adjust your speed to that of the other traffic so you don't have to change speeds unnecessarily. Avoid heavy traffic whenever possible. Always maintain a safe distance from other vehicles so you can avoid unnecessary braking. This also reduces brake wear.
- Drive at a moderate speed. The faster you drive, the more fuel your car uses. Driving at a moderate speed, especially on the highway, is one of the most effective ways to reduce fuel consumption.
- Don't "ride" the brake or clutch pedal. This can increase fuel consumption and also increase wear on these components. In addition, driving with your foot resting on the brake pedal may cause the brakes to overheat, which reduces their effectiveness and may lead to more serious consequences.
- Take care of your tyres. Keep them inflated to the recommended pressure. Incorrect inflation, either too much or too little, results in unnecessary tyre wear. Check the tyre pressures at least once a month.
- Be sure that the wheels are aligned correctly. Improper alignment can result from hitting kerbs or driving too fast over irregular surfaces. Poor alignment causes faster tyre wear and may also result in other problems as well as greater fuel consumption.
- Keep your car in good condition. For better fuel economy and reduced maintenance costs, maintain your car in accordance with the maintenance schedule in Section 7. If you drive your car in severe conditions, more frequent maintenance is required (see Section 7 for details).
- Keep your car clean. For maximum service, your vehicle should be kept clean and free of corrosive materials. It is especially important that mud, dirt, ice, etc. not be allowed to accumulate on the underside of the car. This extra weight can result in increased fuel consumption and also contribute to corrosion.
- Travel lightly. Don't carry unnecessary weight in your car. Weight reduces fuel economy.
- Don't let the engine idle longer than necessary. If you are waiting (and not in traffic), turn off your engine and restart only when you're ready to go.
- Remember, your vehicle does not require extended warm-up. After the engine has started, allow the engine to run for 10 to 20 seconds prior to placing the vehicle in gear. In very cold weather, however, give your engine a slightly longer warm-up period.
- Don't "labour" or "over-rev" the engine. Labouring is driving too slowly in too high a gear resulting in the engine bucking. If this happens, shift to a lower gear. Over-revving is racing the engine beyond its safe limit. This can be avoided by shifting at the recommended speeds.

- Use your air conditioning sparingly. The air conditioning system is operated by engine power so your fuel economy is reduced when you use it.
- Open windows at high speeds can reduce fuel economy.
- Fuel economy is less in crosswinds and headwinds. To help offset some of this loss, slow down when driving in these conditions.

Keeping a vehicle in good operating condition is important both for economy and safety. Therefore, have an authorised HYUNDAI dealer perform scheduled inspections and maintenance.

 **WARNING - Engine off during motion**

Never turn the engine off to coast down hills or anytime the vehicle is in motion. The power steering and power brakes will not function properly without the engine running. Instead, keep the engine on and downshift to an appropriate gear for engine braking effect. In addition, turning off the ignition while driving could engage the steering wheel lock resulting in loss of vehicle steering which could cause serious injury or death.

SPECIAL DRIVING CONDITIONS

E110100AUN-EA

Hazardous driving conditions

When hazardous driving conditions are encountered such as water, snow, ice, mud, sand, or similar hazards, follow these suggestions:

- Drive cautiously and allow extra distance for braking.
- Avoid sudden movements in braking or steering.
- When braking with non-ABS brakes pump the brake pedal with a light up-and-down motion until the vehicle is stopped.

WARNING - ABS

Do not pump the brake pedal on a vehicle equipped with ABS.

- If stalled in snow, mud, or sand, use second gear. Accelerate slowly to avoid spinning the drive wheels.
- Use sand, rock salt, tyre chains, or other non-slip material under the drive wheels to provide traction when stalled in ice, snow, or mud.

WARNING - Downshifting

Downshifting with an automatic transaxle, while driving on slippery surfaces can cause an accident. The sudden change in tyre speed could cause the tyres to skid. Be careful when downshifting on slippery surfaces.

E110200AEN-EA

Rocking the vehicle

If it is necessary to rock the vehicle to free it from snow, sand, or mud, first turn the steering wheel right and left to clear the area around your front wheels. Then, shift back and forth between R (Reverse) and any forward gear in vehicles equipped with an automatic transaxle. Do not race the engine, and spin the wheels as little as possible. If you are still stuck after a few tries, have the vehicle pulled out by a tow vehicle to avoid engine overheating and possible damage to the transaxle.

CAUTION

Prolonged rocking may cause engine over-heating, transaxle damage or failure, and tyre damage.

WARNING - Spinning tyres

Do not spin the wheels, especially at speeds more than 56 km/h (35 mph). Spinning the wheels at high speeds when the vehicle is stationary could cause a tyre to overheat which could result in tyre damage that may injure bystanders.

*** NOTICE**

The ESP system (if equipped) should be turned OFF prior to rocking the vehicle.

WARNING

If your vehicle becomes stuck in snow, mud, sand, etc., then you may attempt to rock the vehicle free by moving it forward and backward. Do not attempt this procedure if people or objects are anywhere near the vehicle. During the rocking operation the vehicle may suddenly move forward or backward as it becomes unstuck, causing injury or damage to nearby people or objects.



OUN056051M

E110300AUN-EA

Smooth cornering

Avoid braking or gear changing in corners, especially when roads are wet. Ideally, corners should always be taken under gentle acceleration. If you follow these suggestions, tyre wear will be held to a minimum.



OCM053010

E110400AUN

Driving at night

Because night driving presents more hazards than driving in the daylight, here are some important tips to remember:

- Slow down and keep more distance between you and other vehicles, as it may be more difficult to see at night, especially in areas where there may not be any street lights.
- Adjust your mirrors to reduce the glare from other driver's headlights.
- Keep your headlights clean and properly aimed on vehicles not equipped with the automatic headlight aiming feature. Dirty or improperly aimed headlights will make it much more difficult to see at night.

- Avoid staring directly at the headlights of oncoming vehicles. You could be temporarily blinded, and it will take several seconds for your eyes to readjust to the darkness.



1VQA3003M

E110500AUN-EA

Driving in the rain

Rain and wet roads can make driving dangerous, especially if you're not prepared for the slick pavement. Here are a few things to consider when driving in the rain:

- A heavy rainfall will make it harder to see and will increase the distance needed to stop your vehicle, so slow down.
- Keep your windshield wiping equipment in good shape. Replace your windshield wiper blades when they show signs of streaking or missing areas on the windshield.

- If your tyres are not in good condition, making a quick stop on wet pavement can cause a skid and possibly lead to an accident. Be sure your tyres are in good shape.
- Turn on your headlights to make it easier for others to see you.
- Driving too fast through large puddles can affect your brakes. If you must go through puddles, try to drive through them slowly.
- If you believe you may have gotten your brakes wet, apply them lightly while driving until normal braking operation returns.

E110600AUN

Driving in flooded areas

Avoid driving through flooded areas unless you are sure the water is no higher than the bottom of the wheel hub. Drive through any water slowly. Allow adequate stopping distance because brake performance may be affected.

After driving through water, dry the brakes by gently applying them several times while the vehicle is moving slowly.



1VQA1004R

E110700AUN-EA

Highway driving

Tyres:

Adjust the tyre inflation pressures to specification. Low tyre inflation pressures will result in overheating and possible failure of the tyres.

Avoid using worn or damaged tyres which may result in reduced traction or tyre failure.

* NOTICE

Never exceed the maximum tyre inflation pressure shown on the tyres.

WARNING

- **Underinflated or overinflated tyres can cause poor handling, loss of vehicle control, and sudden tyre failure leading to accidents, injuries, and even death. Always check the tyres for proper inflation before driving. For proper tyre pressures, refer to section 9, “Tyres and wheels”.**
- **Driving on tyres with no or insufficient tread is dangerous. Worn-out tyres can result in loss of vehicle control, collisions, injury, and even death. Worn-out tyres should be replaced as soon as possible and should never be used for driving. Always check the tyre tread before driving your car. For further information and tread limits, refer to section 7, “Tyres and wheels”.**

Fuel, engine coolant and engine oil:

High speed travel consumes more fuel than urban motoring. Do not forget to check both engine coolant and engine oil.

Drive belt:

A loose or damaged drive belt may result in overheating of the engine.

WINTER DRIVING



E120000AUN-EA

The more severe weather conditions of winter result in greater wear and other problems. To minimise the problems of winter driving, you should follow these suggestions:

E120100AUN-EA

Snowy or icy conditions

To drive your vehicle in deep snow, it may be necessary to use snow tyres or to install tyre chains on your tyres. If snow tyres are needed, it is necessary to select tyres equivalent in size and type of the original equipment tyres. Failure to do so may adversely affect the safety and handling of your car. Furthermore, speeding, rapid acceleration, sudden brake applications, and sharp turns are potentially very hazardous practices.

During deceleration, use engine braking to the fullest extent. Sudden brake applications on snowy or icy roads may cause skids to occur. You need to keep sufficient distance between the vehicle in operation in front and your vehicle. Also, apply the brake gently. It should be noted that installing tyre chains on the tyre will provide a greater driving force, but will not prevent side skids.

* NOTICE

Tyre chains are not legal in all countries. Check the country laws before fitting tyre chains.

E120101AUN-EA

Snow tyres

If you mount snow tyres on your vehicle, make sure they are radial tyres of the same size and load range as the original tyres. Mount snow tyres on all four wheels to balance your vehicle's handling in all weather conditions. Keep in mind that the traction provided by snow tyres on dry roads may not be as high as your vehicle's original equipment tyres. You should drive cautiously even when the roads are clear. Check with the tyre dealer for maximum speed recommendations.

⚠ WARNING - Snow tyre size
Snow tyres should be equivalent in size and type to the vehicle's standard tyres. Otherwise, the safety and handling of your vehicle may be adversely affected.

Do not install studded tyres without first checking local, state and municipal regulations for possible restrictions against their use.

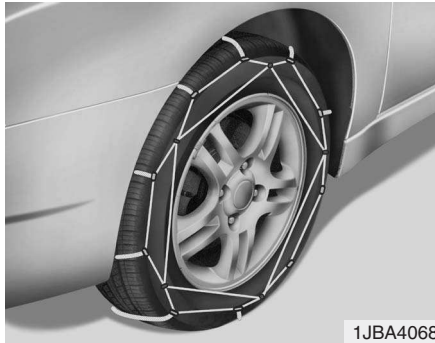

E120102AUN-EA

Tyre chains

Since the sidewalls of radial tyres are thinner, they can be damaged by mounting some types of snow chains on them. Therefore, the use of snow tyres is recommended instead of snow chains. Do not mount tyre chains on vehicles equipped with aluminium wheels; snow chains may cause damage to the wheels. If snow chains must be used, use wire-type chains with a thickness of less than 15 mm (0.59 in). Damage to your vehicle caused by improper snow chain use is not covered by your vehicle manufacturer's warranty.

Install tyre chains only on the front tyres.

*** NOTICE**

Snow chains are not allowed for the tyre of 225/45R17.

⚠ CAUTION

- ***Make sure the snow chains are the correct size and type for your tyres. Incorrect snow chains can cause damage to the vehicle body and suspension and may not be covered by your vehicle manufacturer warranty. Also, the snow chain connecting hooks may be damaged from contacting vehicle components causing the snow chains to come loose from the tyre. Make sure the snow chains are SAE class "S" certified.***
- ***Always check chain installation for proper mounting after driving approximately 0.5 to 1 km (0.3 to 0.6 miles) to ensure safe mounting. Retighten or remount the chains if they are loose.***

Chain installation

When installing chains, follow the manufacturer's instructions and mount them as tightly as you can. Drive slowly with chains installed. If you hear the chains contacting the body or chassis, stop and tighten them. If they still make contact, slow down until it stops. Remove the chains as soon as you begin driving on cleared roads.

⚠ WARNING **- Mounting chains**

When mounting snow chains, park the vehicle on level ground away from traffic. Turn on the vehicle Hazard Warning flashers and place a triangular emergency warning device behind the vehicle if available. Always place the vehicle in park (P), apply the hand brake and turn off the engine before installing snow chains.

⚠ WARNING - Tyre chains

- The use of chains may adversely affect vehicle handling.
- Do not exceed 30 km/h (20 mph) or the chain manufacturer's recommended speed limit, whichever is lower.
- Drive carefully and avoid bumps, holes, sharp turns, and other road hazards, which may cause the vehicle to bounce.
- Avoid sharp turns or locked-wheel braking.

⚠ CAUTION

- *Chains that are the wrong size or improperly installed can damage your vehicle's brake lines, suspension, body and wheels.*
- *Stop driving and retighten the chains any time you hear them hitting the vehicle.*

E120200AUN

Use high quality ethylene glycol coolant

Your vehicle is delivered with high quality ethylene glycol coolant in the cooling system. It is the only type of coolant that should be used because it helps prevent corrosion in the cooling system, lubricates the water pump and prevents freezing. Be sure to replace or replenish your coolant in accordance with the maintenance schedule in section 7. Before winter, have your coolant tested to assure that its freezing point is sufficient for the temperatures anticipated during the winter.

E120300AFD-EA

Check battery and cables

Winter puts additional burdens on the battery system. Visually inspect the battery and cables as described in section 7. The level of charge in your battery can be checked by an authorised HYUNDAI dealer or a service station.

E120400AFD-EA

Change to "winter weight" oil if necessary

In some climates it is recommended that a lower viscosity "winter weight" oil be used during cold weather. See section 9 for recommendations. If you aren't sure what weight oil you should use, consult an authorised HYUNDAI dealer.

E120500AUN

Check spark plugs and ignition system

Inspect your spark plugs as described in section 7 and replace them if necessary. Also check all ignition wiring and components to be sure they are not cracked, worn or damaged in any way.

E120600AUN

To keep locks from freezing

To keep the locks from freezing, squirt an approved de-icer fluid or glycerine into the key opening. If a lock is covered with ice, squirt it with an approved de-icing fluid to remove the ice. If the lock is frozen internally, you may be able to thaw it out by using a heated key. Handle the heated key with care to avoid injury.

E120700AFD-EA

Use approved window washer anti-freeze in system

To keep the water in the window washer system from freezing, add an approved window washer anti-freeze solution in accordance with instructions on the container. Window washer anti-freeze is available from an authorised HYUNDAI dealer and most auto parts outlets. Do not use engine coolant or other types of anti-freeze as these may damage the paint finish.

E120800AUN-EA

Don't let your hand brake freeze

Under some conditions your hand brake can freeze in the engaged position. This is most likely to happen when there is an accumulation of snow or ice around or near the rear brakes or if the brakes are wet. If there is a risk the hand brake may freeze, apply it only temporarily while you put the gear selector lever in P (automatic transaxle) or in first or reverse gear (manual transaxle) and block the rear wheels so the car cannot roll. Then release the hand brake.

E120900AUN

Don't let ice and snow accumulate underneath

Under some conditions, snow and ice can build up under the fenders and interfere with the steering. When driving in severe winter conditions where this may happen, you should periodically check underneath the car to be sure the movement of the front wheels and the steering components is not obstructed.

E121000AUN-EA

Carry emergency equipment

Depending on the severity of the weather where you drive your car, you should carry appropriate emergency equipment. Some of the items you may want to carry include tyre chains, tow straps or chains, flashlight, emergency flares, sand, a shovel, jumper cables, a window scraper, gloves, ground cloth, coveralls, a blanket, etc.

TRAILER TOWING

E140000AFD-EA

If you are considering towing with your car, you should first check with your country's Department of Motor Vehicles to determine their legal requirements.

Since laws vary the requirements for towing trailers, cars, or other types of vehicles or apparatus may differ. Ask an authorised HYUNDAI dealer for further details before towing.

WARNING - Towing a trailer

If you don't use the correct equipment and drive improperly, you can lose control when you pull a trailer. For example, if the trailer is too heavy, the brakes may not work well - or even at all. You and your passengers could be seriously or fatally injured. Pull a trailer only if you have followed all the steps in this section.

WARNING - Weight limits

Before towing, make sure the total trailer weight, gross combination weight, gross vehicle weight, gross axle weight and trailer tongue load are all within the limits.

CAUTION

Pulling a trailer improperly can damage your vehicle and result in costly repairs not covered by your warranty. To pull a trailer correctly, follow the advice in this section.

Your vehicle can tow a trailer. To identify what the vehicle trailering capacity is for your vehicle, you should read the information in "Weight of the trailer" that appears later in this section.

Remember that trailering is different than just driving your vehicle by itself. Trailering means changes in handling, durability, and fuel economy. Successful, safe trailering requires correct equipment, and it has to be used properly.

This section contains many time-tested, important trailering tips and safety rules. Many of these are important for your safety and that of your passengers. Please read this section carefully before you pull a trailer.

Load-pulling components such as the engine, transaxle, wheel assemblies, and tyres are forced to work harder against the load of the added weight. The engine is required to operate at relatively higher speeds and under greater loads. This additional burden generates extra heat. The trailer also adds considerably to wind resistance, increasing the pulling requirements.

E140100AUN-EA

Towbars

It's important to have the correct towbar equipment. Crosswinds, large trucks going by, and rough roads are a few reasons why you'll need the right towbar. Here are some rules to follow:

- Will you have to make any holes in the body of your vehicle when you install a trailer towbar? If you do, then be sure to seal the holes later when you remove the towbar.
If you don't seal them, deadly carbon monoxide (CO) from your exhaust can get into your vehicle, as well as dirt and water.
- The bumpers on your vehicle are not intended for towbars. Do not attach rental towbars or other bumper-type towbars to them. Use only a frame-mounted towbar that does not attach to the bumper.

* NOTICE

We recommend only genuine **HYUNDAI** towbars (the towbars are made and tested in Australia/NZ for local conditions).

E140200AUN-EA

Safety chains

You should always attach chains between your vehicle and your trailer. Cross the safety chains under the tongue of the trailer so that the tongue will not drop to the road if it becomes separated from the towbar.

Instructions about safety chains may be provided by the towbar manufacturer or by the trailer manufacturer. Follow the manufacturer's recommendation for attaching safety chains. Always leave just enough slack so you can turn with your trailer. And, never allow safety chains to drag on the ground.

E140300AUN

Trailer brakes

If your trailer is equipped with a braking system, make sure it conforms to your country's regulations and that it is properly installed and operating correctly.

If your trailer weighs more than the maximum trailer weight without trailer brakes loaded, then it needs its own brakes and they must be adequate. Be sure to read and follow the instructions for the trailer brakes so you'll be able to install, adjust and maintain them properly.

- Don't tap into your vehicle's brake system.



WARNING - Trailer brakes

Do not use a trailer with its own brakes unless you are absolutely certain that you have properly set up the brake system. This is not a task for amateurs. Use an experienced, competent trailer shop for this work.

E140400AUN-EA

Driving with a trailer

Towing a trailer requires a certain amount of experience. Before setting out for the open road, you must get to know your trailer. Acquaint yourself with the feel of handling and braking with the added weight of the trailer. And always keep in mind that the vehicle you are driving is now a good deal longer and not nearly so responsive as your vehicle is by itself.

Before you start, check the trailer towbar and platform, safety chains, electrical connector(s), lights, tyres and mirror adjustment. If the trailer has electric brakes, start your vehicle and trailer moving and then apply the trailer brake controller by hand to be sure the brakes are working. This lets you check your electrical connection at the same time.

During your trip, check occasionally to be sure that the load is secure, and that the lights and any trailer brakes are still working.

E140401AUN

Following distance

Stay at least twice as far behind the vehicle ahead as you would when driving your vehicle without a trailer. This can help you avoid situations that require heavy braking and sudden turns.

E140402AUN-EA

Passing

You'll need more passing distance up ahead when you're towing a trailer. Due to the increased vehicle length, you'll need to go much farther beyond the passed vehicle before you can return to your lane.

E140403AUN

Backing up

Hold the bottom of the steering wheel with one hand. Then, to move the trailer to the left, just move your hand to the left. To move the trailer to the right, move your hand to the right. Always back up slowly and, if possible, have someone guide you.

E140404AUN-EA

Making turns

When you're turning with a trailer, make wider turns than normal. Do this so your trailer won't strike soft shoulders, kerbs, road signs, trees, or other objects. Avoid jerky or sudden manoeuvres. Signal well in advance.

E140405AFD-EA

Turn signals when towing a trailer

When you tow a trailer, your vehicle has to have a different turn signal flasher and extra wiring. The green arrows on your instrument panel will flash whenever you signal a turn or lane change. Properly connected, the trailer lights will also flash to alert other drivers you're about to turn, change lanes, or stop.

When towing a trailer, the green arrows on your instrument panel will flash for turns even if the bulbs on the trailer are burned out. Thus, you may think drivers behind you are seeing your signals when, in fact, they are not. It's important to check occasionally to be sure the trailer bulbs are still working. You must also check the lights every time you disconnect and then reconnect the wires.

Do not connect a trailer lighting system directly to your vehicle's lighting system. Use only an approved trailer wiring harness.

An authorised HYUNDAI dealer can assist you in installing the wiring harness.

 WARNING

Failure to use an approved trailer wiring harness could result in damage to the vehicle electrical system and/or personal injury.

E140406AFD-EA

Driving on grades

Reduce speed and shift to a lower gear before you start down a long or steep downgrade. If you don't shift down, you might have to use your brakes so much that they would get hot and no longer operate efficiently.

On a long uphill grade, shift down and reduce your speed to around 70 km/h (45 mph) to reduce the possibility of engine and transaxle overheating.

If your trailer weighs more than the maximum trailer weight without trailer brakes and you have an automatic transaxle, you should drive in D (Drive) when towing a trailer.

Operating your vehicle in D (Drive) when towing a trailer will minimise heat build up and extend the life of your transaxle.

CAUTION

- **When towing a trailer on steep grades (in excess of 6%) pay close attention to the engine coolant temperature gauge to ensure the engine does not overheat.**

(Continued)

(Continued)

If the needle of the coolant temperature gauge moves across the dial towards "H" or "130°C" (HOT), pull over and stop as soon as it is safe to do so, and allow the engine to idle until it cools down. You may proceed once the engine has cooled sufficiently.

- ***You must decide driving speed depending on trailer weight and uphill grade to reduce the possibility of engine and transaxle overheating.***

*** NOTICE - For petrol engine (2.0l) and diesel engine (1.6l) with Automatic Transaxle**

If you tow a trailer on steep grades (in excess of 12%) at a speed over 30 km/h with the maximum gross vehicle weight and the maximum trailer weight, it can cause the engine or transaxle to overheat. When driving in such conditions, allow the engine to idle until it cools down. You may proceed once when the engine or transaxle has cooled sufficiently.

E140407AUN-EA

Parking on hills

Generally, if you have a trailer attached to your vehicle, you should not park your vehicle on a hill. People can be seriously or fatally injured, and both your vehicle and the trailer can be damaged if unexpectedly roll down hill.

WARNING - Parking on a hill

Parking your vehicle on a hill with a trailer attached could cause serious injury or death, should the trailer break loose.

However, if you ever have to park your trailer on a hill, here's how to do it:

1. Pull the vehicle into the parking space. Turn the steering wheel in the direction of the kerb (right if headed down hill, left if headed up hill).
2. If the vehicle has a manual transaxle, place the car in neutral. If the vehicle has an automatic transaxle, place the car in P (Park).
3. Set the hand brake and shut off the vehicle.
4. Place chocks under the trailer wheels on the down hill side of the wheels.

5. Start the vehicle, hold the brakes, shift to neutral, release the hand brake and slowly release the brakes until the trailer chocks absorb the load.
 6. Reapply the brakes, reapply the hand brake and shift the vehicle to R (Reverse) for manual transaxle or P (Park) for automatic transaxle.
 7. Shut off the vehicle and release the vehicle brakes but leave the hand brake set.
2. Slowly remove your foot from the brake pedal.
 3. Drive slowly until the trailer is clear of the chocks.
 4. Stop and have someone pick up and store the chocks.

E140500AUN-EA

Maintenance when trailer towing

Your vehicle will need service more often when you regularly pull a trailer. Important items to pay particular attention to include engine oil, automatic transaxle fluid, axle lubricant and cooling system fluid. Brake condition is another important item to frequently check. Each item is covered in this manual, and the Index will help you find them quickly. If you're trailering, it's a good idea to review these sections before you start your trip.

Don't forget to also maintain your trailer and towbar. Follow the maintenance schedule that accompanied your trailer and check it periodically. Preferably, conduct the check at the start of each day's driving. Most importantly, all towbar nuts and bolts should be tight.

WARNING - hand brake

It can be dangerous to get out of your vehicle if the hand brake is not firmly set.

If you have left the engine running, the vehicle can move suddenly. You or others could be seriously or fatally injured.

When you are ready to leave after parking on a hill

1. With the manual transaxle in Neutral or automatic transaxle in P (Park), apply your brakes and hold the brake pedal down while you:
 - Start your engine;
 - Shift into gear; and
 - Release the hand brake.

CAUTION

- *Due to higher load during trailer usage, overheating might occur in hot days or during uphill driving. If the coolant gauge indicates over-heating, switch off the A/C and stop the vehicle in a safe area to cool down the engine.*
- *When towing check transaxle fluid more frequently.*
- *If your vehicle is not equipped with the air conditioner, you should install a condenser fan to improve engine performance when towing a trailer.*

E140600BFD-EA

If you do decide to pull a trailer

Here are some important points if you decide to pull a trailer:

- Consider using a sway control. You can ask a towbar dealer about sway control.
- Do not do any towing with your car during its first 2,000 km (1,200 miles) in order to allow the engine to properly run in. Failure to heed this caution may result in serious engine or transaxle damage.
- When towing a trailer, be sure to consult an authorised HYUNDAI dealer for further information on additional requirements such as a towing kit, etc.
- Always drive your vehicle at a moderate speed (less than 100 km/h (60 mph)).
- On a long uphill grade, do not exceed 70 km/h (45 mph) or the posted towing speed limit, whichever is lower.
- The chart contains important considerations that have to do with weight:

Engine		Petrol Engine		Diesel Engine
		1.6 Engine	2.0 Engine	1.6 Engine
Item	Without brake System	500 (1102)	500 (1102)	500 (1102)
	With brake System	1100 (2425)	1200 (2645)	1200 (2645)
Maximum permissible static vertical load on the coupling device kg (lbs.)		75 (165)	75 (165)	75 (165)
Recommended distance from rear wheel centre to coupling point mm (Inch)		5 Door : 820 (32.3) Wagon : 1000 (39.4)		

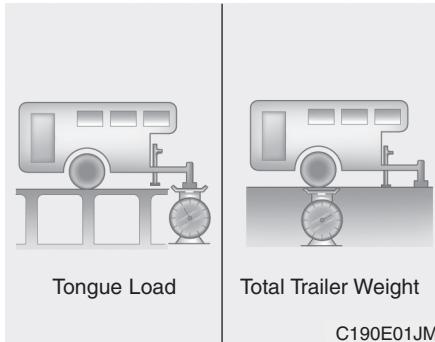

E140601AUN

Weight of the trailer

How heavy can a trailer safely be? It should never weigh more than the maximum trailer weight with trailer brakes. But even that can be too heavy.

It depends on how you plan to use your trailer. For example, speed, altitude, road grades, outside temperature and how often your vehicle is used to pull a trailer are all important. The ideal trailer weight can also depend on any special equipment that you have on your vehicle.

E140602AEN-EA

Weight of the trailer tongue

The tongue load of any trailer is an important weight to measure because it affects the total gross vehicle weight (GVW) of your vehicle. This weight includes the kerb weight of the vehicle, any cargo you may carry in it, and the people who will be riding in the vehicle. And if you will tow a trailer, you must add the tongue load to the GVW because your vehicle will also be carrying that weight.

The trailer tongue should weigh within the limits of the maximum trailer tongue load permissible. After you've loaded your trailer, weigh the trailer and then the tongue, separately, to see if the weights are proper. If they aren't, you may be able to correct them simply by moving some items around in the trailer.

Tongue loads can be increased or decreased by redistributing the load in the trailer. This can be verified by checking the total weight of the loaded trailer and then checking the load on the tongue.

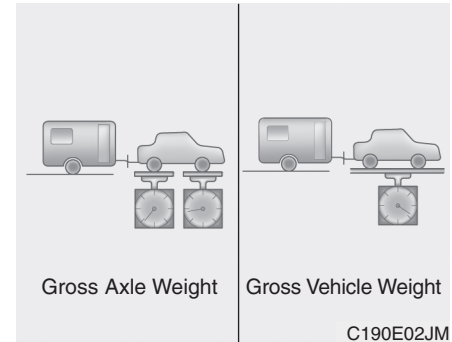

⚠ WARNING - Trailer

- Never load a trailer with more weight in the rear than in the front. The front should be loaded with approximately 60% of the total trailer load; the rear should be loaded with approximately 40% of the total trailer load.

(Continued)

(Continued)

- **Never exceed the maximum weight limits of the trailer or trailer towing equipment. Improper loading can result in damage to your vehicle and/or personal injury. Check weights and loading at a commercial scale or highway patrol office equipped with scales.**
- **An improperly loaded trailer can cause loss of vehicle control.**

VEHICLE WEIGHT

E160000AUN-EA

This section will guide you in the proper loading of your vehicle and/or trailer, to keep your loaded vehicle weight within its design rating capability, with or without a trailer. Properly loading your vehicle will provide maximum return of the vehicle design performance. Before loading your vehicle, familiarize yourself with the following terms for determining your vehicle's weight ratings, with or without a trailer, from the vehicle's specifications and the certification label:

E160100AUN-EA

Base kerb weight

This is the weight of the vehicle including a full tank of fuel and all standard equipment. It does not include passengers, cargo, or optional equipment.

E160200AUN-EA

Vehicle kerb weight

This is the weight of your new vehicle when you picked it up from your dealer plus any aftermarket equipment.

E160300AUN-EA

Cargo weight

This figure includes all weight added to the Base Kerb Weight, including cargo and optional equipment.

E160400AUN-EA

GAW (Gross axle weight)

This is the total weight placed on each axle (front and rear) - including vehicle kerb weight and all payload.

E160500AUN-EA

GAWR (Gross axle weight rating)

This is the maximum allowable weight that can be carried by a single axle (front or rear). These numbers are shown on the certification label. The total load on each axle must never exceed its GAWR.

E160600AUN-EA

GVW (Gross vehicle weight)

This is the Base Kerb Weight plus actual Cargo Weight plus passengers.

E160700AUN-EA

GVWR (Gross vehicle weight rating)

This is the maximum allowable weight of the fully loaded vehicle (including all options, equipment, passengers and cargo). The GVWR is shown on the certification label.

E160800AUN-EA

Overloading

⚠ WARNING - Vehicle weight
The gross axle weight rating (GAWR) and the gross vehicle weight rating (GVWR) for your vehicle are on the certification label. Exceeding these ratings can cause an accident or vehicle damage. You can calculate the weight of your load by weighing the items (and people) before putting them in the vehicle. Be careful not to overload your vehicle.

Road warning / 6-2
In case of an emergency while driving / 6-2
If the engine will not start / 6-3
Emergency starting / 6-4
If the engine overheats / 6-6
If you have a flat tyre / 6-7
Towing / 6-15

ROAD WARNING

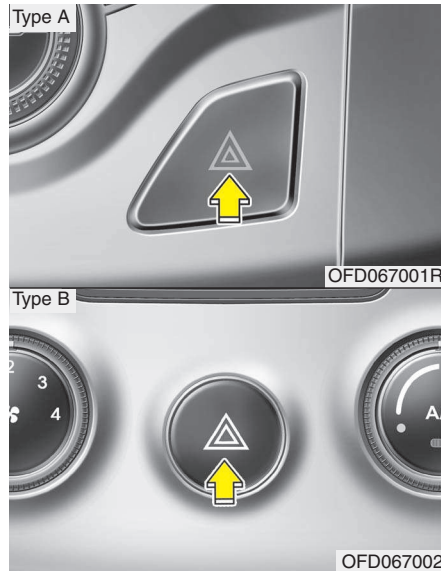

F010100AUN-EA

Hazard warning flasher

The hazard warning flasher serves as a warning to other drivers to exercise extreme caution when approaching, overtaking, or passing your vehicle.

It should be used whenever emergency repairs are being made or when the vehicle is stopped near the edge of a roadway.

Depress the flasher switch with the ignition switch in any position. The flasher switch is located in the centre console switch panel. All turn signal lights will flash simultaneously.

- The hazard warning flasher operates whether your vehicle is running or not.
- The turn signals do not work when the hazard flasher is on.
- Care must be taken when using the hazard warning flasher while the vehicle is being towed.

IN CASE OF AN EMERGENCY WHILE DRIVING

F020100AUN

If the engine stalls at a crossroad or crossing

- If the engine stalls at a crossroad or crossing, set the shift lever in the N (Neutral) position and then push the vehicle to a safe place.
- If your vehicle has a manual transaxle not equipped with a ignition lock switch, the vehicle can move forward by shifting to the 2(second) or 3(third) gear and then turning the starter without depressing the clutch pedal.

F020200AUN-EA

If you have a flat tyre while driving

If a tyre goes flat while you are driving:

1. Take your foot off the accelerator pedal and let the car slow down while driving straight ahead. Do not apply the brakes immediately or attempt to pull off the road as this may cause a loss of control. When the car has slowed to such a speed that it is safe to do so, brake carefully and pull off the road. Drive off the road as far as possible and park on firm, level ground. If you are on a divided highway, do not park in the median area between the two traffic lanes.

2. When the car is stopped, turn on your emergency hazard flashers, set the hand brake and put the transaxle in P (automatic transaxle) or reverse (manual transaxle).
3. Have all passengers get out of the car. Be sure they all get out on the side of the car that is away from traffic.
4. When changing a flat tyre, follow the instruction provided later in this section.

F020300AFD-EA

If engine stalls while driving

1. Reduce your speed gradually, keeping a straight line. Move cautiously off the road to a safe place.
2. Turn on your emergency flashers.
3. Try to start the engine again. If your vehicle will not start, contact an authorised HYUNDAI dealer or seek other qualified assistance.

IF THE ENGINE WILL NOT START

F030100AUN

If engine doesn't turn over or turns over slowly

1. If your car has an automatic transaxle, be sure the gear selector lever is in N (Neutral) or P (Park) and the emergency brake is set.
2. Check the battery connections to be sure they are clean and tight.
3. Turn on the interior light. If the light dims or goes out when you operate the starter, the battery is discharged.
4. Check the starter connections to be sure they are securely tightened.
5. Do not push or pull the vehicle to start it. See instructions for "Jump starting".

⚠ WARNING

If the engine will not start, do not push or pull the car to start it. This could result in a collision or cause other damage. In addition, push or pull starting may cause the catalytic converter to be overloaded and create a fire hazard.

F030200AFD-EA

If engine turns over normally but does not start

1. Check fuel level.
2. With the ignition switch in the OFF position, check all connectors at ignition, coil and spark plugs. Reconnect any connectors that may be disconnected or loose.
3. Check the fuel line in the engine compartment.
4. If the engine still does not start, call an authorised HYUNDAI dealer or seek other qualified assistance.

EMERGENCY STARTING

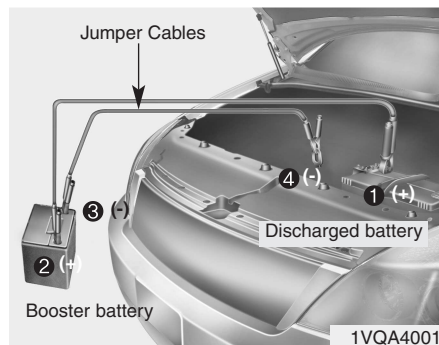

F040100AUN

Jump starting

Jump starting can be dangerous if done incorrectly. Therefore, to avoid harm to yourself or damage to your vehicle or battery, follow the jump starting procedures. If in doubt, we strongly recommend that you have a competent technician or towing service jump start your vehicle.

CAUTION

Use only a 12-volt jumper system. You can damage a 12-volt starting motor, ignition system, and other electrical parts beyond repair by use of a 24-volt power supply (either two 12-volt batteries in series or a 24-volt motor generator set).

WARNING - Battery

Never attempt to check the electrolyte level of the battery as this may cause the battery to rupture or explode causing serious injury.

WARNING - Battery

- **Keep all flames or sparks away from the battery. The battery produces hydrogen gas which may explode if exposed to flame or sparks.**
- **Do not attempt to jump start the vehicle if the discharged battery is frozen or if the electrolyte level is low; the battery may rupture or explode.**

F040101AFD-EA

Jump starting procedure

1. Make sure the booster battery is 12-volt and that its negative terminal is grounded.
2. If the booster battery is in another vehicle, do not allow the vehicles to touch.
3. Turn off all unnecessary electrical loads.
4. Connect the jumper cables in the exact sequence shown in the illustration. First connect one end of a jumper cable to the positive terminal of the discharged battery (1), then connect the other end to the positive terminal on the booster battery (2). Proceed to connect one end of the other jumper cable to the negative terminal of the booster battery (3), then the other end to a solid, stationary, metallic point (for example, the engine lifting bracket) away from the battery (4). Do not connect it to or near any part that moves when the engine is cranked.

Do not allow the jumper cables to contact anything except the correct battery terminals or the correct ground. Do not lean over the battery when making connections.

 **CAUTION - Battery cables**
Do not connect the jumper cable from the negative terminal of the booster battery to the negative terminal of the discharged battery. This can cause the discharged battery to overheat and crack, releasing battery acid.

5. Start the engine of the vehicle with the booster battery and let it run at 2,000 rpm, then start the engine of the vehicle with the discharged battery.

If the cause of your battery discharging is not apparent, you should have your vehicle checked by an authorised HYUNDAI dealer.

F040200AUN

Push-starting

Your manual transaxle-equipped vehicle should not be push-started because it might damage the emission control system.

Vehicles equipped with automatic transaxle cannot be push-started.

Follow the directions in this section for jump-starting.

 **WARNING**

Never tow a vehicle to start it because the sudden surge forward when the engine starts could cause a collision with the tow vehicle.

What to do in an emergency

IF THE ENGINE OVERHEATS

F050000AFD-EA

If your temperature gauge indicates overheating, you experience a loss of power, or hear loud pinging or knocking, the engine is probably too hot. If this happens, you should:

1. Pull off the road and stop as soon as it is safe to do so.
2. Place the gear selector lever in P (automatic transaxle) or neutral (manual transaxle) and set the hand brake. If the air conditioning is on, turn it off.
3. If engine coolant is running out under the car or steam is coming out from underneath the bonnet, stop the engine. Do not open the bonnet until the coolant has stopped running or the steaming has stopped. If there is no visible loss of engine coolant and no steam, leave the engine running and check to be sure the engine cooling fan is operating. If the fan is not running, turn the engine off.
4. While engine is switched off, check to see if the water pump drive belt is missing. If it is not missing, check to see that it is tight. If the drive belt seems to be satisfactory, check for coolant leaking from the radiator, hoses or under the car. (If the air conditioning had been in use, it is normal for cold water to be draining from it when you stop).

WARNING

While the engine is running, keep hair, hands and clothing away from moving parts such as the fan and drive belts to prevent injury.

5. If the water pump drive belt is broken or engine coolant is leaking out, stop the engine immediately and call the nearest authorised HYUNDAI dealer for assistance.

WARNING

Do not remove the radiator cap when the engine is hot. This may result in coolant being blown out of the opening and cause serious burns.

6. If you cannot find the cause of the overheating, wait until the engine temperature has returned to normal. Then, if coolant has been lost, carefully add coolant to the reservoir to bring the fluid level in the reservoir up to the halfway mark.
7. Proceed with caution, keeping alert for further signs of overheating. If overheating happens again, call an authorised HYUNDAI dealer for assistance.

CAUTION

Serious loss of coolant indicates there is a leak in the cooling system and this should be checked as soon as possible by an authorised HYUNDAI dealer.

IF YOU HAVE A FLAT TYRE

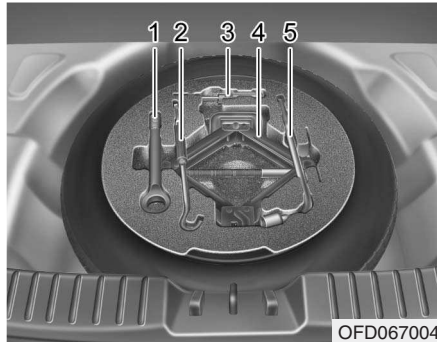

F070100AFD-EA

OFD067004

Jack and tools

The spare tyre, jack, jack handle, the wheel brace are stored in the luggage compartment. Remove the luggage under tray out of the way to reach this equipment.

- (1) Towing hook
- (2) Jack handle
- (3) Screwdriver
- (4) Jack
- (5) Wheel brace

F070101AUN-EA

Jacking instructions

The jack is provided for emergency tyre changing only.

To prevent the jack from “rattling” while the vehicle is in motion, store it properly.

Follow jacking instructions to reduce the possibility of personal injury.

⚠ WARNING - Changing tyres

- **Never attempt vehicle repairs in the traffic lanes of a public road or highway.**
- **Always move the vehicle completely off the road and onto the shoulder before trying to change a tyre. The jack should be used on level firm ground. If you cannot find a firm, level place off the road, call a towing service company for assistance.**
- **Be sure to use the correct front and rear jacking positions on the vehicle; never use the bumpers or any other part of the vehicle for jack support.**

(Continued)

(Continued)

- The vehicle can easily roll off the jack causing serious injury or death. No person should place any portion of their body under a vehicle that is supported only by a jack; use vehicle support stands.
- Do not start or run the engine while the vehicle is on the jack.
- Do not allow anyone to remain in the vehicle while it is on the jack.
- Make sure any children present are in a secure place away from the road and from the vehicle to be raised with the jack.

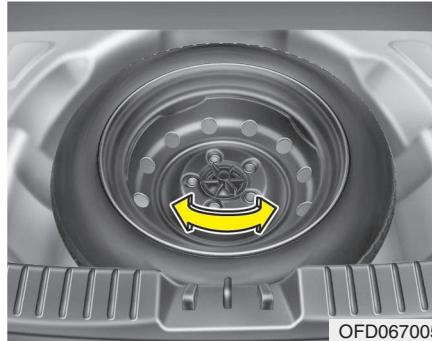

F070200AFD-EA

Removing and storing the spare tyre

Turn the tyre hold-down wing bolt counterclockwise.

Store the tyre in the reverse order of removal.

To prevent the spare tyre and tools from “rattling” while the vehicle is in motion, store them properly.



OED066033M

F070300AFD-EA

Changing tyres

1. Park on a level surface and apply the hand brake firmly.
2. Shift the shift lever into R (Reverse) with manual transaxle or P (Park) with automatic transaxle.
3. Activate the hazard warning flasher.



4. Remove the wheel brace, jack, jack handle, and spare tyre from the vehicle.
5. Block both the front and rear of the wheel that is diagonally opposite the jack position.

⚠ WARNING - Changing a tyre

- To prevent vehicle movement while changing a tyre, always set the hand brake fully, and always block the wheel diagonally opposite the wheel being changed.
- We recommend that the wheels of the vehicle be chocked, and that no person remain in a vehicle that is being jacked.

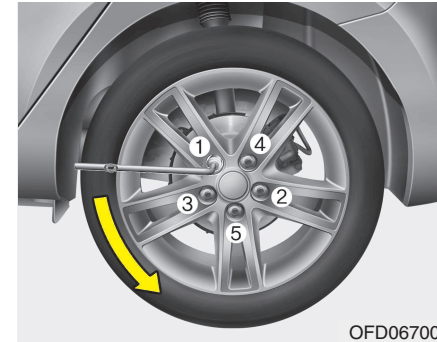

6. Loosen the wheel nuts counter-clockwise one turn each, but do not remove any nut until the tyre has been raised off the ground.

What to do in an emergency

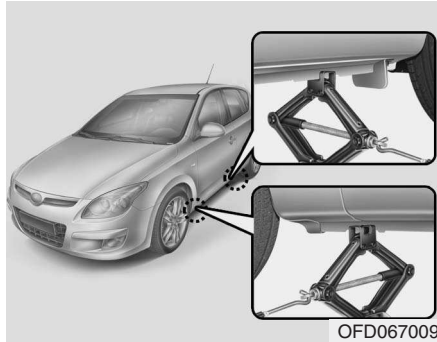

7. Place the jack at the front or rear jacking position closest to the tyre you are changing. Place the jack at the designated locations under the frame. The jacking positions are plates welded to the frame with two tabs and a raised dot to index with the jack.

⚠ WARNING - Jack location
To reduce the possibility of injury, be sure to use only the jack provided with the vehicle and in the correct jack position; never use any other part of the vehicle for jack support.



8. Insert the jack handle into the jack and turn it clockwise, raising the vehicle until the tyre just clears the ground. This measurement is approximately 30 mm (1.2 in). Before removing the wheel nuts, make sure the vehicle is stable and that there is no chance for movement or slippage.

9. Loosen the wheel nuts and remove them with your fingers. Slide the wheel off the studs and lay it flat so it cannot roll away. To put the wheel on the hub, pick up the spare tyre, line up the holes with the studs and slide the wheel onto them. If this is difficult, tip the wheel slightly and get the top hole in the wheel lined up with the top stud. Then jiggle the wheel back and forth until the wheel can slide over the other studs.

⚠ WARNING

Wheels and wheel covers may have sharp edges. Handle them carefully to avoid possible severe injury. Before putting the wheel into place, be sure that there is nothing on the hub or wheel (such as mud, tar, gravel, etc.) that prevents the wheel from fitting solidly against the hub.

If there is, remove it. If there is not good contact on the mounting surface between the wheel and hub, the wheel nuts could come loose and cause the loss of a wheel. Loss of a wheel may result in loss of control of the vehicle. This may cause serious injury or death.

10. To reinstall the wheel, hold it on the studs, put the wheel nuts on the studs and tighten them finger tight. The nuts should be installed with their tapered small diameter ends directed inward. Jiggle the tyre to be sure it is completely seated, then tighten the nuts as much as possible with your fingers again.
11. Lower the car to the ground by turning the wheel brace counter-clockwise.

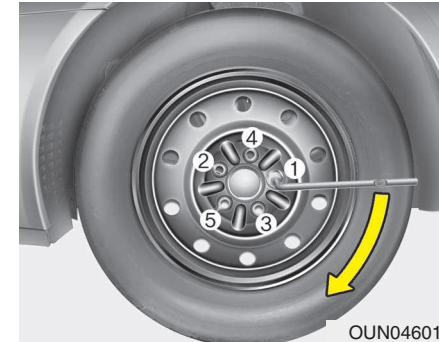

Then position the wheel brace as shown in the drawing and tighten the wheel nuts. Be sure the socket is seated completely over the nut. Do not stand on the wheel brace handle or use an extension pipe over the wheel brace handle.

Go around the wheel tightening every other nut until they are all tight. Then double-check each nut for tightness. After changing wheels, have an authorised HYUNDAI dealer tighten the wheel nuts to their proper torque as soon as possible.

Wheel nut tightening torque:

Steel wheel & aluminium alloy wheel:
9~11 kg.m (65~79 lb.ft)

What to do in an emergency

If you have a tyre gauge, remove the valve cap and check the air pressure. If the pressure is lower than recommended, drive slowly to the nearest service station and inflate to the correct pressure. If it is too high, adjust it until it is correct. Always reinstall the valve cap after checking or adjusting tyre pressure. If the cap is not replaced, air may leak from the tyre. If you lose a valve cap, buy another and install it as soon as possible.

After you have changed wheels, always secure the flat tyre in its place and return the jack and tools to their proper storage locations.

CAUTION

Your vehicle has metric threads on the wheel studs and nuts. Make certain during wheel removal that the same nuts that were removed are reinstalled - or, if replaced, that nuts with metric threads and the same chamfer configuration are used. Installation of a non-metric thread nut on a metric stud or vice-versa will not secure the wheel to the hub properly and will damage the stud so that it must be replaced.

Note that most wheel nuts do not have metric threads. Be sure to use extreme care in checking for thread style before installing aftermarket wheel nuts or wheels. If in doubt, consult an authorised HYUNDAI dealer.

WARNING - Wheel studs

If the studs are damaged, they may lose their ability to retain the wheel. This could lead to the loss of the wheel and a collision resulting in serious injuries.

To prevent the jack, jack handle, wheel brace and spare tyre from rattling while the vehicle is in motion, store them properly.

WARNING - Inadequate spare tyre pressure

Check the inflation pressures as soon as possible after installing the spare tyre. Adjust it to the specified pressure, if necessary. Refer to "Tyres and wheels" in section 9.

F070301AUN-EA

Important - use of compact spare tyre (if equipped)

Your vehicle is equipped with a compact spare tyre. This compact spare tyre takes up less space than a regular-size tyre. This tyre is smaller than a conventional tyre and is designed for temporary use only.

⚠ CAUTION

- ***You should drive carefully when the compact spare is in use. The compact spare should be replaced by the proper conventional tyre and rim at the first opportunity.***
- ***The operation of this vehicle is not recommended with more than one compact spare tyre in use at the same time.***

⚠ WARNING

The compact spare tyre is for emergency use only. Do not operate your vehicle on this compact spare at speeds over 80 km/h (50 mph). The original tyre should be repaired or replaced as soon as is possible to avoid failure of the spare possibly leading to personal injury or death.

The compact spare should be inflated to 420 kPa (60 psi).

*** NOTICE**

Check the inflation pressure after installing the spare tyre. Adjust it to the specified pressure, as necessary.

When using a compact spare tyre, observe the following precautions:

- Under no circumstances should you exceed 80 km/h (50 mph); a higher speed could damage the tyre.
- Ensure that you drive slowly enough for the road conditions to avoid all hazards. Any road hazard, such as a pothole or debris, could seriously damage the compact spare.
- Any continuous road use of this tyre could result in tyre failure, loss of vehicle control, and possible personal injury.
- Do not exceed the vehicle's maximum load rating or the load-carrying capacity shown on the sidewall of the compact spare tyre.
- Avoid driving over obstacles. The compact spare tyre diameter is smaller than the diameter of a conventional tyre and reduces the ground clearance approximately 25 mm (1 inch), which could result in damage to the vehicle.

What to do in an emergency

- Do not take this vehicle through an automatic car wash while the compact spare tyre is installed.
- Do not use tyre chains on the compact spare tyre. Because of the smaller size, a tyre chain will not fit properly. This could damage the vehicle and result in loss of the chain.
- The compact spare tyre should not be installed on the front axle if the vehicle must be driven in snow or on ice.
- Do not use the compact spare tyre on any other vehicle because this tyre has been designed especially for your vehicle.
- The compact spare tyre's tread life is shorter than a regular tyre. Inspect your compact spare tyre regularly and replace worn compact spare tyres with the same size and design, mounted on the same wheel.
- The compact spare tyre should not be used on any other wheels, nor should standard tyres, snow tyres, wheel covers or trim rings be used with the compact spare wheel. If such use is attempted, damage to these items or other car components may occur.
- Do not use more than one temporary spare tyre at a time.
- Do not tow a trailer while the temporary spare tyre is installed.

TOWING

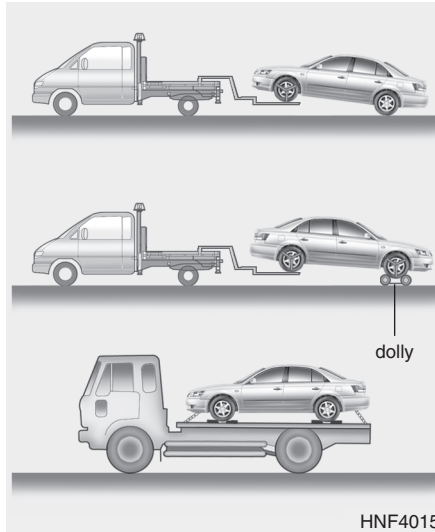

HNF4015

F080100AFD-EA

Towing service

If emergency towing is necessary, we recommend having it done by an authorised HYUNDAI dealer or a commercial tow-truck service. Proper lifting and towing procedures are necessary to prevent damage to the vehicle. The use of wheel dollies or flatbed is recommended.

For trailer towing guidelines information, refer to "Trailer towing" in section 5.

It is acceptable to tow the vehicle with the rear wheels on the ground (without dollies) and the front wheels off the ground. If any of the loaded wheels or suspension components are damaged or the vehicle is being towed with the front wheels on the ground, use a towing dolly under the front wheels.

When being towed by a commercial tow truck and wheel dollies are not used, the front of the vehicle should always be lifted, not the rear.

CAUTION

Before towing, check the level of the automatic transaxle fluid. If it is below the "HOT" range on the dipstick, add fluid. If you cannot add fluid, a towing dolly must be used.

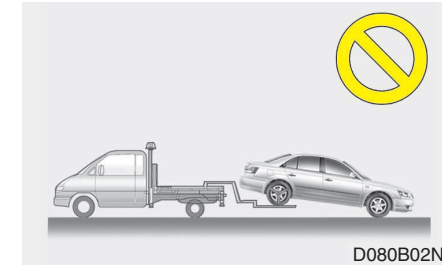

D080B02NF

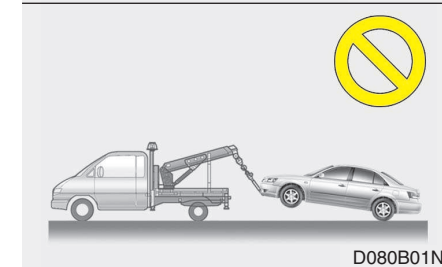

D080B01NF

CAUTION

- *Do not tow the vehicle backwards with the front wheels on the ground as this may cause damage to the vehicle.*
- *Do not tow with sling-type equipment. Use wheel lift or flatbed equipment.*

What to do in an emergency

When towing your vehicle in an emergency without wheel dollies :

1. Set the ignition switch in the ACC position.
2. Place the transaxle shift lever in N (Neutral).
3. Release the hand brake.

CAUTION

Failure to place the transaxle shift lever in N (Neutral) may cause internal damage to the transaxle.

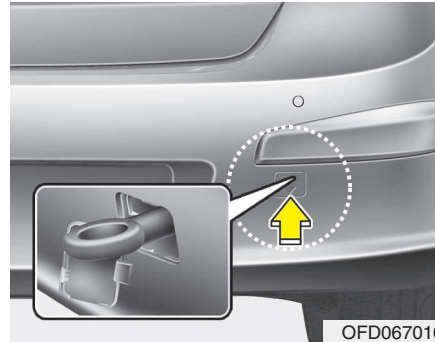

F080200AUN

Removable towing hook (rear)

1. Open the tailgate, and remove the towing hook from the tool case.
2. Remove the hole cover pressing the lower part of the cover on the rear bumper.

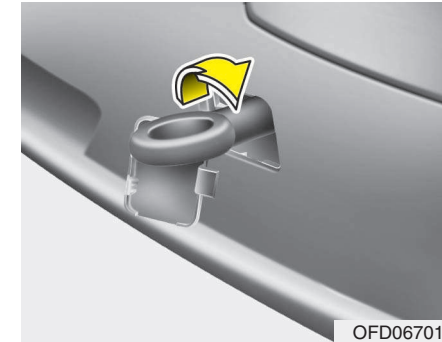

3. Install the towing hook by turning it clockwise into the hole until it is fully secured.
4. Remove the towing hook and install the cover after use.

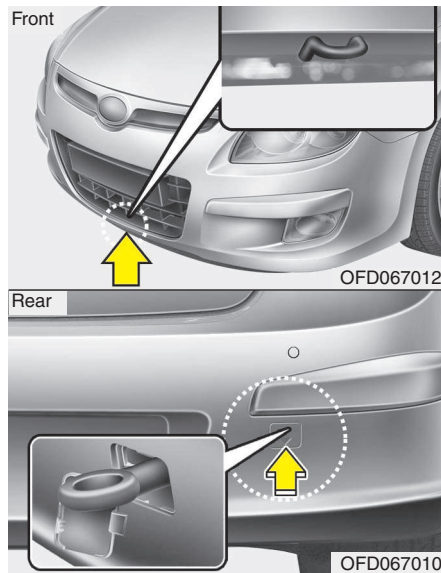

F080300AFD-EA

Emergency towing

If towing is necessary, we recommend you to have it done by an authorised HYUNDAI dealer or a commercial tow truck service.

If towing service is not available in an emergency, your vehicle may be temporarily towed using a cable or chain secured to the emergency towing hook under the front (or rear) of the vehicle.

Use extreme caution when towing the vehicle. A driver must be in the vehicle to steer it and operate the brakes.

Towing in this manner may be done only on hard-surfaced roads for a short distance and at low speeds. Also, the wheels, axles, power train, steering and brakes must all be in good condition.

- Do not use the towing hooks to pull a vehicle out of mud, sand or other conditions from which the vehicle cannot be driven out under its own power.
- Avoid towing a vehicle heavier than the vehicle doing the towing.
- The drivers of both vehicles should communicate with each other frequently.

CAUTION

- **Attach a towing strap to the tow hook.**
 - **Using a portion of the vehicle other than the tow hooks for towing may damage the body of your vehicle.**
 - **Use only a cable or chain specifically intended for use in towing vehicles. Securely fasten the cable or chain to the towing hook provided.**
-
- Before emergency towing, check that the hook is not broken or damaged.
 - Fasten the towing cable or chain securely to the hook.
 - Do not jerk the hook. Apply steady and even force.
 - To avoid damaging the hook, do not pull from the side or at a vertical angle. Always pull straight ahead.

⚠ WARNING

Use extreme caution when towing the vehicle.

- Avoid sudden starts or erratic driving manoeuvres which would place excessive stress on the emergency towing hook and towing cable or chain. The hook and towing cable or chain may break and cause serious injury or damage.
- If the disabled vehicle cannot be moved, do not forcibly continue the towing. Contact an authorised HYUNDAI dealer or a commercial tow truck service for assistance.
- Tow the vehicle as straight ahead as possible.
- Keep away from the vehicle during towing.

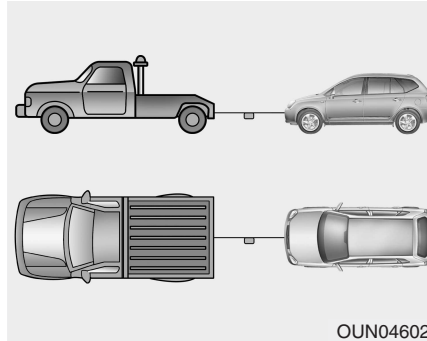

OUN046024

E080301AUN-EA

Emergency towing precautions

- Turn the ignition switch to ACC so the steering wheel isn't locked.
 - Place the transaxle shift lever in N (Neutral).
 - Release the hand brake.
 - Press the brake pedal with more force than normal since you will have reduced brake performance.
 - More steering effort will be required because the power steering system will be disabled.
 - If you are driving down a long hill, the brakes may overheat and brake performance will be reduced. Stop often and let the brakes cool off.
- Use a towing strap less than 5 m (16 feet) long. Attach a white or red cloth (about 30 cm (12 inches) wide) in the middle of the strap for easy visibility.
 - Drive carefully so that the towing strap is not loosened during towing.

⚠ CAUTION - Automatic transaxle

- *If the car is being towed with all four wheels on the ground, it can be towed only from the front. Be sure that the transaxle is in neutral. Be sure the steering is unlocked by placing the ignition switch in the ACC position. A driver must be in the towed vehicle to operate the steering and brakes.*
- *To avoid serious damage to the automatic transaxle, limit the vehicle speed to 15 km/h (10 mph) and drive less than 1.5 km (1 mile) when towing.*
- *Before towing, check the automatic transaxle fluid leak under your vehicle. If the automatic transaxle fluid is leaking, a flatbed equipment or towing dolly must be used.*

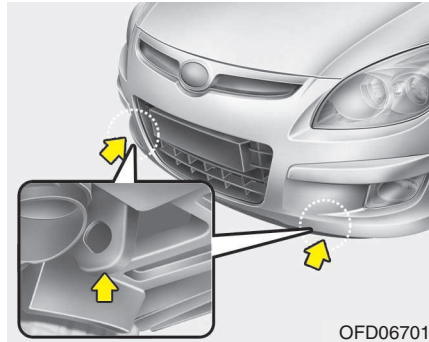

F080400AFD

**Tie-down hook
(for flatbed towing)**

⚠ WARNING

Do not use the hooks under the front of the vehicle for towing purposes. These hooks are designed **ONLY** for transport tie-down. If the tie-down hooks are used for towing, the tie-down hooks or front bumper will be damaged and this could lead to serious injury.

Engine compartment / 7-2
Maintenance services / 7-4
Owner maintenance / 7-6
Scheduled maintenance service / 7-8
Explanation of scheduled maintenance items / 7-21
Engine oil / 7-24
Engine coolant / 7-25
Brake and clutch fluid / 7-28
Automatic transaxle fluid / 7-29
Washer fluid / 7-31
Hand brake / 7-31
Fuel filter / 7-32
Air cleaner / 7-33
Climate control air filter / 7-34
Wiper blades / 7-36
Battery / 7-40

Maintenance

7

Tyres and wheels / 7-43
Fuses / 7-53
Light bulbs / 7-62
Appearance care / 7-68
Emission control system / 7-74

ENGINE COMPARTMENT

■ Petrol Engine (1.6L)

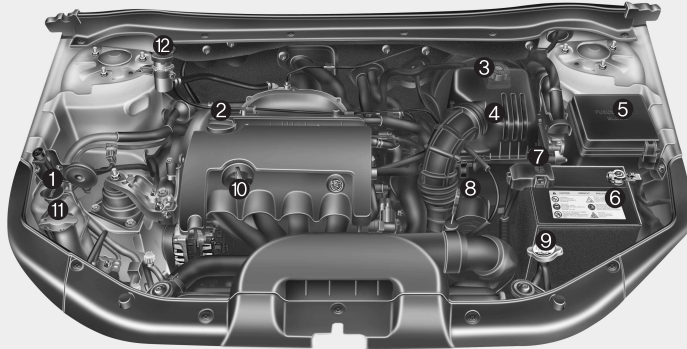

1. Engine coolant reservoir
 2. Engine oil filler cap
 3. Brake fluid reservoir
 4. Air cleaner
 5. Fuse box
 6. Negative battery terminal
 7. Positive battery terminal
 8. Auto transaxle oil dipstick*
 9. Radiator cap
 10. Engine oil dipstick
 11. Windshield washer fluid reservoir
 12. Clutch fluid reservoir*
- * : if equipped

■ Petrol Engine (2.0L)

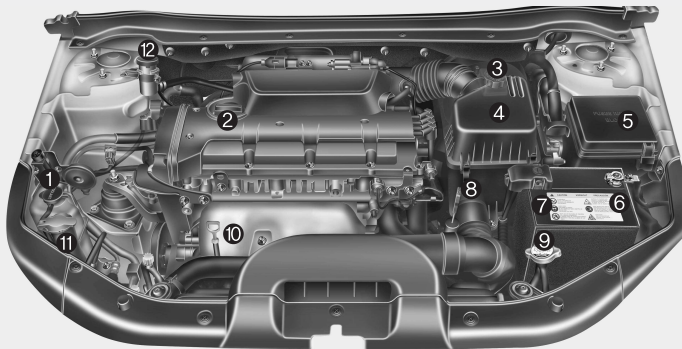

OED070001R/OED070002R

G010000AFD-EA

■ Diesel Engine (1.6L)

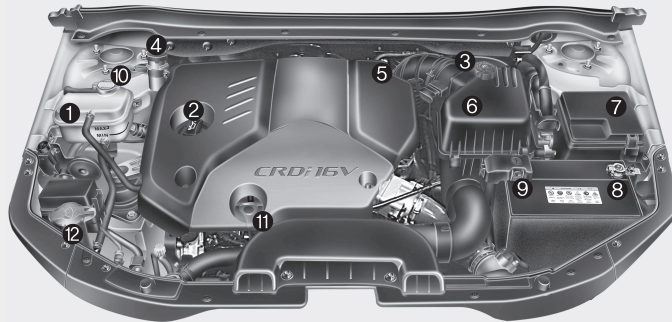

1. Engine coolant reservoir
2. Engine oil filler cap
3. Brake fluid reservoir
4. Clutch fluid reservoir
5. Fuel filter
6. Air cleaner
7. Fuse box
8. Negative battery terminal
9. Positive battery terminal
10. Radiator cap
11. Engine oil dipstick
12. Windshield washer fluid reservoir

OFD077004R

MAINTENANCE SERVICES

G020000AFD-EA

You should exercise the utmost care to prevent damage to your vehicle and injury to yourself whenever performing any maintenance or inspection procedures.

Should you have any doubts concerning the inspection or servicing of your vehicle, we strongly recommend that you have an authorised HYUNDAI dealer perform this work.

An authorised HYUNDAI dealer has factory-trained technicians and genuine HYUNDAI parts to service your vehicle properly. For expert advice and quality service, see an authorised HYUNDAI dealer.

Inadequate, incomplete or insufficient servicing may result in operational problems with your vehicle that could lead to vehicle damage, an accident, or personal injury.

G020100AFD-EA

Owner's responsibility

* NOTICE

Maintenance Service and Record Retention are the owner's responsibility.

You should retain documents that show proper maintenance has been performed on your vehicle in accordance with the scheduled maintenance service charts shown on the following pages. You need this information to establish your compliance with the servicing and maintenance requirements of your vehicle warranties.

Detailed warranty information is provided in your Service Passport.

Repairs and adjustments required as a result of improper maintenance or a lack of required maintenance are not covered.

We recommend you have your vehicle maintained and repaired by an authorised HYUNDAI dealer. An authorised HYUNDAI dealer meets HYUNDAI's high service quality standards and receives technical support from HYUNDAI in order to provide you with a high level of service satisfaction.

G020200AFD-EA

Owner maintenance precautions

Improper or incomplete service may result in problems. This section gives instructions only for the maintenance items that are easy to perform.

As explained earlier in this section, several procedures can be done only by an authorised HYUNDAI dealer with special tools.

*** NOTICE**

Improper owner maintenance during the warranty period may affect warranty coverage. For details, read the separate Service Passport provided with the vehicle. If you're unsure about any servicing or maintenance procedure, have it done by an authorised HYUNDAI dealer.

 WARNING - Maintenance work

- Performing maintenance work on a vehicle can be dangerous. You can be seriously injured while performing some maintenance procedures. If you lack sufficient knowledge and experience or the proper tools and equipment to do the work, have it done by an authorised HYUNDAI dealer.
- Working under the bonnet with the engine running is dangerous. It becomes even more dangerous when you wear jewelry or loose clothing. These can become entangled in moving parts and result in injury. Therefore, if you must run the engine while working under the bonnet, make certain that you remove all jewelry (especially rings, bracelets, watches, and necklaces) and all neckties, scarves, and similar loose clothing before getting near the engine or cooling fans.

 WARNING - Diesel Engine

Never work on injection system with engine running or within 30 seconds after shutting off engine. High-pressure pump, rail, injectors and high-pressure pipes are subject to high pressure even after the engine stopped. The fuel jet produced by fuel leaks may cause serious injury, if it touches the body. People using pacemakers should not move than 30cm closer to the ECU or wiring harness within the engine room while engine is running, since the high currents in the electronic engine control system produce considerable magnetic fields.

OWNER MAINTENANCE

G030000AFD-EA

The following lists are vehicle checks and inspections that should be performed by the owner or an authorised HYUNDAI dealer at the frequencies indicated to help ensure safe, dependable operation of your vehicle.

Any adverse conditions should be brought to the attention of your dealer as soon as possible.

These Owner Maintenance Checks are generally not covered by warranties and you may be charged for labour, parts and lubricants used.

Owner maintenance schedule

G030101AUN-EA

When you stop for fuel:

- Check the engine oil level.
- Check coolant level in coolant reservoir.
- Check the windshield washer fluid level.
- Look for low or under-inflated tyres.

WARNING

Be careful when checking your engine coolant level when the engine is hot. Scalding hot coolant and steam may blow out under pressure. This could cause burns or other serious injury.

G030102AUN-EA

While operating your vehicle:

- Note any changes in the sound of the exhaust or any smell of exhaust fumes in the vehicle.
- Check for vibrations in the steering wheel. Notice any increased steering effort or looseness in the steering wheel, or change in its straight-ahead position.
- Notice if your vehicle constantly turns slightly or “pulls” to one side when travelling on smooth, level road.
- When stopping, listen and check for unusual sounds, pulling to one side, increased brake pedal travel or “hard-to-push” brake pedal.
- If any slipping or changes in the operation of your transaxle occurs, check the transaxle fluid level.
- Check automatic transaxle P (Park) function.
- Check hand brake.
- Check for fluid leaks under your vehicle (water dripping from the air conditioning system during or after use is normal).

G030103AUN-EA

At least monthly:

- Check coolant level in the engine coolant reservoir.
- Check the operation of all exterior lights, including the stoplights, turn signals and hazard warning flashers.
- Check the inflation pressures of all tyres including the spare.

G030104AUN-EA

***At least twice a year
(i.e., every Spring and Fall) :***

- Check radiator, heater and air conditioning hoses for leaks or damage.
- Check windshield washer spray and wiper operation. Clean wiper blades with clean cloth dampened with washer fluid.
- Check headlight alignment.
- Check muffler, exhaust pipes, shields and clamps.
- Check the lap/shoulder belts for wear and function.
- Check for worn tyres and loose wheel nuts.

G030105AFD-EA

At least once a year :

- Clean body and door drain holes.
- Lubricate door hinges and checks, and bonnet hinges.
- Lubricate door and bonnet locks and latches.
- Lubricate door rubber weatherstrips.
- Check the air conditioning system.
- Inspect and lubricate automatic transaxle linkage and controls.
- Clean battery and terminals.
- Check the brake (and clutch) fluid level.

SCHEDULED MAINTENANCE SERVICE

G040000AFD-EA

Follow Normal Maintenance Schedule if the vehicle is usually operated where none of the following conditions apply. If any of the following conditions apply, follow Maintenance Under Severe Usage Conditions.

- Repeated short distance driving.
- Driving in dusty conditions or sandy areas.
- Extensive use of brakes.
- Driving in areas where salt or other corrosive materials are being used.
- Driving on rough or muddy roads.
- Driving in mountainous areas.
- Extended periods of idling or low speed operation.
- Driving for a prolonged period in cold temperatures and/or extremely humid climates.
- More than 50% driving in heavy city traffic during hot weather above 32°C (90°F).

If your vehicle is operated under the above conditions, you should inspect, replace or refill more frequently than the following Normal Maintenance Schedule. After 96 month or 120,000 km continue to follow the prescribed maintenance intervals.

NORMAL MAINTENANCE SCHEDULE - PETROL ENGINE

G040100AFD-EA

MAINTENANCE ITEM	MAINTENANCE INTERVALS	Number of months or driving distance, whichever comes first								
		Months	12	24	36	48	60	72	84	96
		Km×1,000	15	30	45	60	75	90	105	120
Drive belts * ¹		I	I	I	I	I	I	I	I	
Engine oil and engine oil filter * ²		R	R	R	R	R	R	R	R	
Engine timing belt	2.0L Petrol	Inspect every 90,000 km or 48 months and replace every 140,000 km or 72 months * ³								
Tensioner/idler	2.0L Petrol	Inspect when timing belt is inspected or replaced								
Air cleaner filter		I	I	R	I	I	R	I	I	
Spark plugs		Replace every 40,000 km * ³								
Valve clearance * ⁴		Inspect every 96,000 km or 48 months * ³								

I : Inspect and if necessary, adjust, correct, clean or replace.

R : Replace or change.

*¹ : Adjust alternator and power steering (and water pump drive belt) and air conditioner drive belt (if equipped).
Inspect and if necessary correct or replace.

*² : Check the engine oil level and leak every 500 km or before starting a long trip.

*³ : For your convenience, it can be replaced prior to it's interval when you do maintenance of other items.

*⁴ : Inspect for excessive valve noise and/or engine vibration and adjust if necessary. A qualified technician should perform the operation.

NORMAL MAINTENANCE SCHEDULE - PETROL ENGINE (CONT.)

MAINTENANCE ITEM	MAINTENANCE INTERVALS	Number of months or driving distance, whichever comes first								
		Months	12	24	36	48	60	72	84	96
		Km×1,000	15	30	45	60	75	90	105	120
Vapour hose and fuel filler cap			I			I		I		I
Vacuum and crankcase ventilation hoses			I			I		I		I
Fuel filter					R					R
Fuel lines, hoses and connections		I	I	I	I	I	I	I	I	I
Cooling system		Inspect "Coolant level adjustment and leak" every day Inspect "Water pump" when replacing the drive belt or timing belt								

I : Inspect and if necessary, adjust, correct, clean or replace.

R : Replace or change.

NORMAL MAINTENANCE SCHEDULE - PETROL ENGINE (CONT.)

MAINTENANCE ITEM	MAINTENANCE INTERVALS	Number of months or driving distance, whichever comes first								
		Months	12	24	36	48	60	72	84	96
		Km×1,000	15	30	45	60	75	90	105	120
Engine coolant ¹⁵		At first, replace at 210,000 km or 10 years: after that, replace every 30,000 km or 24 months ¹⁶								
Battery condition		I	I	I	I	I	I	I	I	
All electrical systems			I			I		I		
Brake lines, hoses and connections		I	I	I	I	I	I	I	I	
Brake pedal, clutch pedal			I			I		I		
Hand brake		I	I	I	I	I	I	I	I	
Brake/clutch fluid		I	R	I	R	I	R	I	R	
Disc brakes and pads		I	I	I	I	I	I	I	I	

I : Inspect and if necessary, adjust, correct, clean or replace.

R : Replace or change.

¹⁵ : When adding coolant, use only deionized water or soft water for your vehicle and never mix hard water in the coolant filled at the factory. An improper coolant mixture can result in serious malfunction or engine damage.

¹⁶ : For your convenience, it can be replaced prior to it's interval when you do maintenance of other items.

NORMAL MAINTENANCE SCHEDULE - PETROL ENGINE (CONT.)

MAINTENANCE ITEM	MAINTENANCE INTERVALS	Number of months or driving distance, whichever comes first								
		Months	12	24	36	48	60	72	84	96
		Km×1,000	15	30	45	60	75	90	105	120
Steering gear rack, linkage and boots		I	I	I	I	I	I	I	I	
Driveshaft and boots		I	I	I	I	I	I	I	I	
Tyre (pressure & tread wear)		I	I	I	I	I	I	I	I	
Front suspension ball joints		I	I	I	I	I	I	I	I	
Bolt and nuts on chassis and body		I	I	I	I	I	I	I	I	
Air conditioner refrigerant (if equipped)		I	I	I	I	I	I	I	I	
Air conditioner compressor (if equipped)		I	I	I	I	I	I	I	I	
Climate control air filter (if equipped)		R	R	R	R	R	R	R	R	
Manual transaxle fluid (if equipped)					I				I	
Automatic transaxle fluid (if equipped)					I				I	

I : Inspect and if necessary, adjust, correct, clean or replace.

R : Replace or change.

MAINTENANCE UNDER SEVERE USAGE CONDITIONS - PETROL ENGINE

G040200BFD-EA

The following items must be serviced more frequently on cars mainly used under severe driving conditions. Refer to the chart below for the appropriate maintenance intervals.

R : Replace I : Inspect and if necessary, adjust, correct, clean or replace

MAINTENANCE ITEM		Maintenance operation	Maintenance intervals	Driving condition
Engine oil and engine oil filter		R	Every 7,500 km or 6 months	A, B, C, D, E, F, G, H, I, J
Air cleaner filter		R	Replace more frequently depending on the condition	C, E
Spark plugs		R	Replace more frequently depending on the condition	B, H
Engine timing belt tensioner and idler	2.0L Petrol	R	Every 90,000 km or 48 months	D, E, F, G
Manual transaxle fluid (if equipped)		R	Every 120,000 km	C, D, E, G, H, I, J
Automatic transaxle fluid (if equipped)		R	Every 100,000 km	A, C, D, E, F, G, H, I, J
Steering gear rack, linkage and boots		I	Inspect more frequently depending on the condition	C, D, E, F, G

Maintenance

MAINTENANCE ITEM	Maintenance operation	Maintenance intervals	Driving condition
Front suspension ball joints	I	Inspect more frequently depending on the condition	C, D, E, F, G
Disc brakes and pads, calipers and rotors	I	Inspect more frequently depending on the condition	C, D, E, G, H
Hand brake	I	Inspect more frequently depending on the condition	C, D, G, H
Driveshaft and boots	I	Inspect more frequently depending on the condition	C, D, E, F, G, H, I, J
Climate control air filter (if equipped)	R	Replace more frequently depending on the condition	C, E

Severe driving conditions

A : Repeated short distance driving

B : Extensive idling

C : Driving in dusty, rough roads

D : Driving in areas using salt or other corrosive materials or in very cold weather

E : Driving in sandy areas

F : More than 50 % driving in heavy city traffic during hot weather above 32°C (90°F)

G : Driving in mountainous areas.

H : Towing a trailer

I : Driving for patrol car, taxi, commercial car or vehicle towing

J : Driving over 170 km/h

NORMAL MAINTENANCE SCHEDULE - DIESEL ENGINE

G040300AFD-EA

MAINTENANCE ITEM	MAINTENANCE INTERVALS	Number of months or driving distance, whichever comes first								
		Months	12	24	36	48	60	72	84	96
		Km×1,000	15	30	45	60	75	90	105	120
Drive belts *1		I	I	I	I	I	I	I	I	
Engine oil and engine oil filter *2		R	R	R	R	R	R	R	R	
Tensioner/idler/damper pulley		Inspect when replacing the drive belt								
Air cleaner filter		I	I	R	I	I	R	I	I	

I : Inspect and if necessary, adjust, correct, clean or replace.

R : Replace or change.

*1 : Adjust alternator and power steering (and water pump drive belt) and air conditioner drive belt (if equipped).
Inspect and if necessary correct or replace.

*2 : Check the engine oil level and leak every 500 km or before starting a long trip.

NORMAL MAINTENANCE SCHEDULE - DIESEL ENGINE (CONT.)

MAINTENANCE ITEM	MAINTENANCE INTERVALS	Number of months or driving distance, whichever comes first								
		Months	12	24	36	48	60	72	84	96
		Km×1,000	15	30	45	60	75	90	105	120
Fuel filler cap			I			I		I		I
PCV and Crank ventilation hose		I	I	I	I	I	I	I	I	I
Vacuum hose (for EGR & throttle body)		I	I	I	I	I	I	I	I	I
Vacuum pump and vacuum hose		I	I	I	I	I	I	I	I	I
Vacuum pump oil hose		I	I	I	I	I	I	I	I	I
Fuel filter cartridge ^{*3, *4}			R			R		R		R
Fuel lines, hoses and connections		I	I	I	I	I	I	I	I	I
Cooling system		Inspect "Coolant level adjustment and leak" every day Inspect "Water pump" when replacing the drive belt or timing belt								

I : Inspect and if necessary, adjust, correct, clean or replace.

R : Replace or change.

^{*3} : For your convenience, it can be replaced prior to it's interval when you do maintenance of other items.

^{*4} : If the diesel fuel specifications don't meet the European standards EN590, replace it more frequently.
 Consult an authorised HYUNDAI dealer for details.

NORMAL MAINTENANCE SCHEDULE - DIESEL ENGINE (CONT.)

MAINTENANCE ITEM	MAINTENANCE INTERVALS	Number of months or driving distance, whichever comes first								
		Months	12	24	36	48	60	72	84	96
		Km×1,000	15	30	45	60	75	90	105	120
Engine coolant * ⁵		At first, replace at 210,000 km or 10 years: after that, replace every 30,000 km or 24 months * ⁶								
Battery condition		I	I	I	I	I	I	I	I	
All electrical systems			I		I		I		I	
Brake lines, hoses and connections		I	I	I	I	I	I	I	I	
Brake pedal, clutch pedal			I		I		I		I	
Hand brake		I	I	I	I	I	I	I	I	
Brake/clutch fluid		I	R	I	R	I	R	I	R	
Disc brakes and pads		I	I	I	I	I	I	I	I	

I : Inspect and if necessary, adjust, correct, clean or replace.

R : Replace or change.

*⁵ : When adding coolant, use only deionized water or soft water for your vehicle and never mix hard water in the coolant filled at the factory. An improper coolant mixture can result in serious malfunction or engine damage.

*⁶ : For your convenience, it can be replaced prior to it's interval when you do maintenance of other items.

NORMAL MAINTENANCE SCHEDULE - DIESEL ENGINE (CONT.)

MAINTENANCE ITEM	MAINTENANCE INTERVALS	Number of months or driving distance, whichever comes first								
		Months	12	24	36	48	60	72	84	96
		Km×1,000	15	30	45	60	75	90	105	120
Steering gear rack, linkage and boots		I	I	I	I	I	I	I	I	I
Drive shaft and boots		I	I	I	I	I	I	I	I	I
Tyre (pressure & tread wear)		I	I	I	I	I	I	I	I	I
Front suspension ball joints		I	I	I	I	I	I	I	I	I
Bolt and nuts on chassis and body		I	I	I	I	I	I	I	I	I
Air conditioner refrigerant (if equipped)		I	I	I	I	I	I	I	I	I
Air conditioner compressor (if equipped)		I	I	I	I	I	I	I	I	I
Climate control air filter (if equipped)		R	R	R	R	R	R	R	R	R
Manual transaxle fluid (if equipped)					I					I
Automatic transaxle fluid (if equipped)					I					I

I : Inspect and if necessary, adjust, correct, clean or replace.

R : Replace or change.

MAINTENANCE UNDER SEVERE USAGE CONDITIONS - DIESEL ENGINE

G040400AFD-EA

The following items must be serviced more frequently on cars mainly used under severe driving conditions. Refer to the chart below for the appropriate maintenance intervals.

R : Replace I : Inspect and if necessary, adjust, correct, clean or replace

MAINTENANCE ITEM	Maintenance operation	Maintenance intervals	Driving condition
Engine oil and engine oil filter	R	Every 7,500 km or 6 months	A, B, C, F, G, H, I, J, K, L
Air cleaner filter	R	Replace more frequently depending on the condition	C, E
Manual transaxle fluid (if equipped)	R	Every 120,000 km	C, D, E, G, H, I, K
Automatic transaxle fluid (if equipped)	R	Every 100,000 km	A, C, D, E, F G, H, I, K
Steering gear rack, linkage and boots	I	Inspect more frequently depending on the condition	C, D, E, F, G

Maintenance

MAINTENANCE ITEM	Maintenance operation	Maintenance intervals	Driving condition
Front suspension ball joints	I	Inspect more frequently depending on the condition	C, D, E, F, G
Disc brakes and pads, calipers and rotors	I	Inspect more frequently depending on the condition	C, D, E, G, H
Hand brake	I	Inspect more frequently depending on the condition	C, D, G, H
Drive shaft and boots	I	Inspect more frequently depending on the condition	C, D, E, F, G, H, I
Climate control air filter (if equipped)	R	Inspect more frequently depending on the condition	C, E

Severe driving conditions

A : Repeated short distance driving

B : Extensive idling

C : Driving in dusty, rough roads

D : Driving in areas using salt or other corrosive materials or in very cold weather

E : Driving in sandy areas

F : More than 50 % driving in heavy city traffic during hot weather above 32 °C (90 °F)

G : Driving in mountainous areas.

H : Towing a trailer

I : Driving for patrol car, taxi, commercial car or vehicle towing

J : Driving in very cold weather

K : Driving over 170 km/h

L : Frequently driving in stop-and-go conditions

EXPLANATION OF SCHEDULED MAINTENANCE ITEMS

G050100AUN

Engine oil and filter

The engine oil and filter should be changed at the intervals specified in the maintenance schedule. If the car is being driven in severe conditions, more frequent oil and filter changes are required.

G050200AUN

Drive belts

Inspect all drive belts for evidence of cuts, cracks, excessive wear or oil saturation and replace if necessary. Drive belts should be checked periodically for proper tension and adjusted as necessary.

G050300AFD-EA

Fuel filter (cartridge)

A clogged filter can limit the speed at which the vehicle may be driven, damage the emission system and cause multiple issues such as hard starting. If an excessive amount of foreign matter accumulates in the fuel tank, the filter may require replacement more frequently.

After installing a new filter, run the engine for several minutes, and check for leaks at the connections. Fuel filters should be installed by an authorised HYUNDAI dealer.

G050400AFD-EA

Fuel lines, fuel hoses and connections

Check the fuel lines, fuel hoses and connections for leakage and damage. Have an authorised HYUNDAI dealer replace any damaged or leaking parts immediately.



WARNING - Diesel only

Never work on injection system with engine running or within 30 seconds after shutting off engine. High pressure pump, rail, injectors and high pressure pipes are subject to high pressure even after the engine stopped. The fuel jet produced by fuel leaks may cause serious injury, if it touch the body. People using pacemakers should not move than 30cm closer to the ECU or wiring harness within the engine room while engine is running, since the high currents in the Common Rail system produce considerable magnetic fields.

G050500AUN

Timing belt (if equipped)

Inspect all parts related to the timing belt for damage and deformation. Replace any damaged parts immediately.

G050600AUN-EA

Vapour hose and fuel filler cap

The vapour hose and fuel filler cap should be inspected at those intervals specified in the maintenance schedule. Make sure that a new vapour hose or fuel filler cap is correctly replaced.

G050700AUN

Vacuum crankcase ventilation hoses (if equipped)

Inspect the surface of hoses for evidence of heat and/or mechanical damage. Hard and brittle rubber, cracking, tears, cuts, abrasions, and excessive swelling indicate deterioration. Particular attention should be paid to examine those hose surfaces nearest to high heat sources, such as the exhaust manifold.

Inspect the hose routing to assure that the hoses do not come in contact with any heat source, sharp edges or moving component which might cause heat damage or mechanical wear. Inspect all hose connections, such as clamps and couplings, to make sure they are secure, and that no leaks are present. Hoses should be replaced immediately if there is any evidence of deterioration or damage.

G050800AFD

Air cleaner filter

A Genuine HYUNDAI air cleaner filter is recommended when the filter is replaced.

G050900AUN-EA

Spark plugs (for petrol engine)

Make sure to install new spark plugs of the correct heat range.

G051000AFD-EA

Valve clearance (if equipped)

Inspect excessive valve noise and/or engine vibration and adjust if necessary. An authorised HYUNDAI dealer should perform the operation.

G051100AUN

Cooling system

Check the cooling system parts, such as radiator, coolant reservoir, hoses and connections for leakage and damage. Replace any damaged parts.

G051200AUN

Coolant

The coolant should be changed at the intervals specified in the maintenance schedule.

G051300AUN

**Manual transaxle fluid
(if equipped)**

Inspect the manual transaxle fluid according to the maintenance schedule.

G051400AUN-EA

**Automatic transaxle fluid
(if equipped)**

The fluid level should be in the "HOT" range of the dipstick, after the engine and transaxle are at normal operating temperature. Check the automatic transaxle fluid level with the engine running and the transaxle in neutral, with the hand brake properly applied.

G051500AUN

Brake hoses and lines

Visually check for proper installation, chafing, cracks, deterioration and any leakage. Replace any deteriorated or damaged parts immediately.

G051600AUN

Brake fluid

Check brake fluid level in the brake fluid reservoir. The level should be between "MIN" and "MAX" marks on the side of the reservoir. Use only hydraulic brake fluid conforming to DOT 3 or DOT 4 specification.

G051700AUN-EA

Hand brake

Inspect the hand brake system including the hand brake lever and cables.

G051900AUN

Brake pads, calipers and rotors

Check the pads for excessive wear, discs for run out and wear, and calipers for fluid leakage.

G052100AUN

Suspension mounting bolts

Check the suspension connections for looseness or damage. Retighten to the specified torque.

G052200AUN

**Steering gear box, linkage &
boots/lower arm ball joint**

With the vehicle stopped and engine off, check for excessive free-play in the steering wheel.

Check the linkage for bends or damage. Check the dust boots and ball joints for deterioration, cracks, or damage. Replace any damaged parts.

G052400AUN

Drive shafts and boots

Check the drive shafts, boots and clamps for cracks, deterioration, or damage. Replace any damaged parts and, if necessary, repack the grease.

G052500AUN

**Air conditioning refrigerant
(if equipped)**

Check the air conditioning lines and connections for leakage and damage.

ENGINE OIL

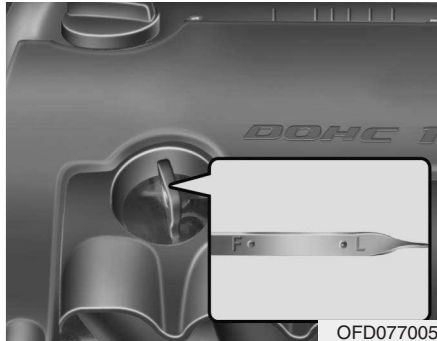

G060100AUN

Checking the engine oil level

1. Be sure the vehicle is on level ground.
2. Start the engine and allow it to reach normal operating temperature.
3. Turn the engine off and wait for a few minutes (about 5 minutes) for the oil to return to the oil pan.

4. Pull the dipstick out, wipe it clean, and re-insert it fully.

⚠ WARNING - Radiator hose
Be very careful not to touch the radiator hose when checking or adding the engine oil as it may be hot enough to burn you.

5. Pull the dipstick out again and check the level. The level should be between F and L.



If it is near or at L, add enough oil to bring the level to F. **Do not overfill.**

Use a funnel to help prevent oil from being spilled on engine components.

Use only the specified engine oil. (Refer to "Recommended lubricants and capacities" in section 9.)

G060200AFD-EA

Changing the engine oil and filter

Have engine oil and filter changed by an authorised HYUNDAI dealer according to the Maintenance Schedule at the beginning of this section.

**⚠ WARNING**

Used engine oil may cause irritation or cancer of the skin if left in contact with the skin for prolonged periods of time. Used engine oil contains chemicals that have caused cancer in laboratory animals. Always protect your skin by washing your hands thoroughly with soap and warm water as soon as possible after handling used oil.

ENGINE COOLANT

G070000AFD-EA

The high-pressure cooling system has a reservoir filled with year-round antifreeze coolant. The reservoir is filled at the factory.

Check the antifreeze protection and coolant concentration level at least once a year, at the beginning of the winter season, and before travelling to a colder climate.

G070100AFD-EA

Checking the coolant level**⚠ WARNING - Removing radiator cap**

- Never attempt to remove the radiator cap while the engine is operating or hot. Doing so might lead to cooling system and engine damage and could result in serious personal injury from escaping hot coolant or steam.

(Continued)

(Continued)

- Turn the engine off and wait until it cools down. Use extreme care when removing the radiator cap. Wrap a thick towel around it, and turn it counterclockwise slowly to the first stop. Step back while the pressure is released from the cooling system. When you are sure all the pressure has been released, press down on the cap, using a thick towel, and continue turning counterclockwise to remove it.
- Even if the engine is not operating, do not remove the radiator cap or the drain plug while the engine and radiator are hot. Hot coolant and steam may still blow out under pressure, causing serious injury.

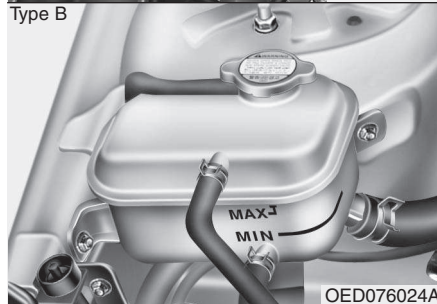
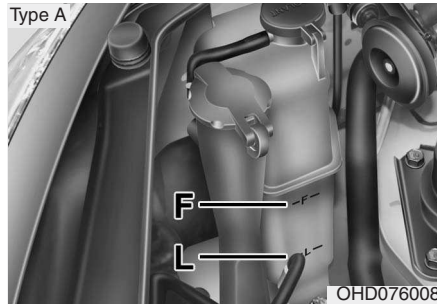

Check the condition and connections of all cooling system hoses and heater hoses. Replace any swollen or deteriorated hoses.

The coolant level should be filled between F (MAX) and L (MIN) marks on the side of the coolant reservoir when the engine is cool.

If the coolant level is low, add enough specified coolant to provide protection against freezing and corrosion. Bring the level to F (MAX), but do not overfill. If frequent coolant refill is required, see an authorised HYUNDAI dealer for a cooling system inspection.

G070101AUN-EA

Recommended engine coolant

- When adding coolant, use only deionized water or soft water for your vehicle and never mix hard water in the coolant filled at the factory. An improper coolant mixture can result in serious malfunction or engine damage.
- The engine in your vehicle has aluminium engine parts and must be protected by an ethylene-glycol-based coolant to prevent corrosion and freezing.
- DO NOT USE alcohol or methanol coolant or mix them with the specified coolant.
- Do not use a solution that contains more than 60% antifreeze or less than 35% antifreeze, which would reduce the effectiveness of the solution.

For mixture percentage, refer to the following table.

Ambient Temperature	Mixture Percentage (volume)	
	Antifreeze	Water
-15°C (5°F)	35	65
-25°C (-13°F)	40	60
-35°C (-31°F)	50	50
-45°C (-49°F)	60	40

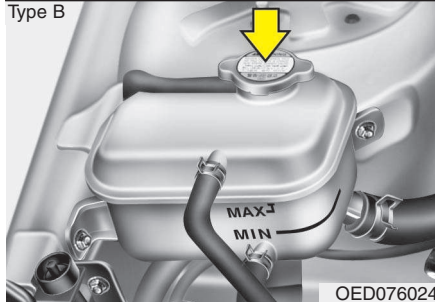
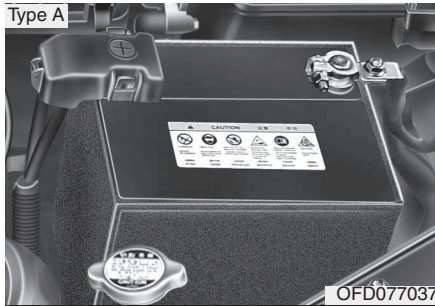

G070200AFD-EA

Changing the coolant

Have coolant changed by an authorised HYUNDAI dealer according to the Maintenance Schedule at the beginning of this section.

CAUTION

Put a thick cloth or fabric around the radiator cap before refilling the coolant in order to prevent the coolant from overflowing into engine parts such as generator.

WARNING - Coolant

- Do not use radiator coolant or antifreeze in the washer fluid reservoir.
- Radiator coolant can severely obscure visibility when sprayed on the windshield and may cause loss of vehicle control or damage to paint and body trim.

WARNING - Radiator cap

Do not remove the radiator cap when the engine and radiator are hot. Scalding hot coolant and steam may blow out under pressure causing serious injury.

BRAKE AND CLUTCH (IF EQUIPPED) FLUID

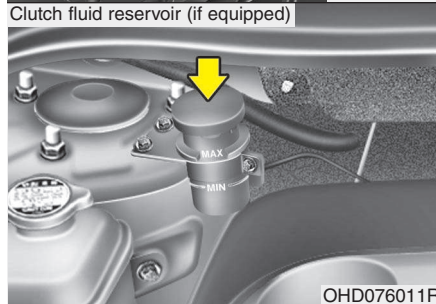
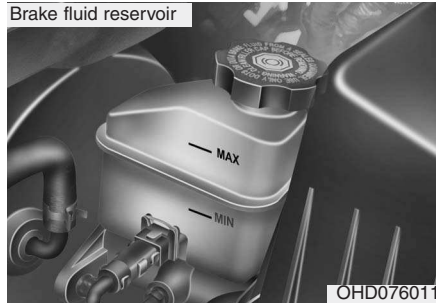

G080100AFD-EA

Checking the brake/clutch fluid level

Check the fluid level in the reservoir periodically. The fluid level should be between MAX and MIN marks on the side of the reservoir.

Before removing the reservoir cap and adding brake/clutch fluid, clean the area around the reservoir cap thoroughly to prevent brake/clutch fluid contamination. If the level is low, add fluid to the MAX level. The level will fall with accumulated mileage. This is a normal condition associated with the wear of the brake linings. If the fluid level is excessively low, have the brake system checked by an authorised HYUNDAI dealer.

Use only the specified brake/clutch fluid. (Refer to "Recommended lubricants and capacities" in section 9.)

Never mix different types of fluid.

⚠ WARNING - Loss of brake fluid

In the event the brake system requires frequent additions of fluid, the vehicle should be inspected by an authorised HYUNDAI dealer.

⚠ WARNING - Brake fluid

When changing and adding brake/clutch fluid, handle it carefully. Do not let it come in contact with your eyes. If brake/clutch fluid should come in contact with your eyes, immediately flush them with a large quantity of fresh tap water. Have your eyes examined by a doctor as soon as possible.

⚠ CAUTION

Do not allow brake/clutch fluid to contact the vehicle's body paint, as paint damage will result. Brake/clutch fluid, which has been exposed to open air for an extended time should never be used as its quality cannot be guaranteed. It should be disposed of properly. Don't put in the wrong kind of fluid. A few drops of mineral-based oil, such as engine oil, in your brake clutch system can damage brake clutch system parts.

AUTOMATIC TRANSAXLE FLUID (IF EQUIPPED)

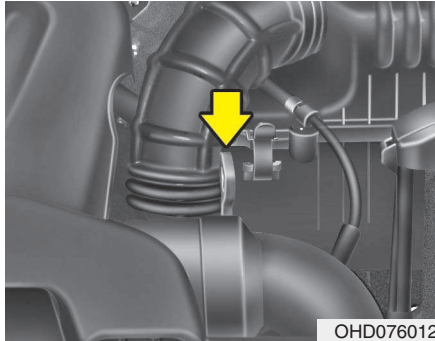

G100100AFD-EA

Checking the automatic transaxle fluid level

The automatic transaxle fluid level should be checked regularly.

Keep the vehicle on the level ground with the hand brake applied and check the fluid level according to the following procedure.

1. Place the selector lever in N (Neutral) position and confirm the engine is running at normal idle speed.

2. After the transaxle is warmed up sufficiently (fluid temperature 70~80°C (158~176°F), for example by 10 minutes usual driving, move the shift lever through all positions then place the selector lever in "N (Neutral) or P (Park)" position.



3. Confirm that the fluid level is in "HOT" range on the level gauge. If the fluid level is lower, add the specified fluid from the fill hole. If the fluid level is higher, drain the fluid from the drain hole.
4. If the fluid level is checked in cold condition (fluid temperature 20~30°C (68~86°F) add the fluid to "C" (COLD) line and then recheck the fluid level according to the above step 2.

⚠ WARNING - Transaxle fluid
The transaxle fluid level should be checked when the engine is at normal operating temperature. This means that the engine, radiator, radiator hose and exhaust system etc., are very hot. Exercise great care not to burn yourself during this procedure.

⚠ CAUTION

- *Low fluid level causes transaxle slippage. Overfilling can cause foaming, loss of fluid and transaxle malfunction.*
- *The use of a non-specified fluid could result in transaxle malfunction and failure.*

⚠ WARNING - Hand brake
To avoid sudden movement of the vehicle, apply hand brake and depress the brake pedal before moving the shift lever.

*** NOTICE**
“C” (COLD) range is for reference only and should NOT be used to determine transaxle fluid level.

*** NOTICE**
New automatic transaxle fluid should be red. The red dye is added so the assembly plant can identify it as automatic transaxle fluid and distinguish it from engine oil or antifreeze. The red dye, which is not an indicator of fluid quality, is not permanent. As the vehicle is driven, the automatic transaxle fluid will begin to look darker. The color may eventually appear light brown. Therefore, have an authorised HYUNDAI dealer change the automatic transaxle fluid according to the Scheduled Maintenance at the beginning of this section.

Use only the specified automatic transaxle fluid. (Refer to “Recommended lubricants and capacities” in section 9.)

G100200AFD-EA
Changing the automatic transaxle fluid

Have automatic transaxle fluid changed by an authorised HYUNDAI dealer according to the Maintenance Schedule at the beginning of this section.

WASHER FLUID

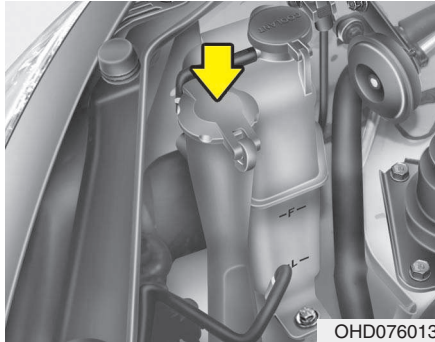

G120100AUN

Checking the washer fluid level

The reservoir is translucent so that you can check the level with a quick visual inspection.

Check the fluid level in the washer fluid reservoir and add fluid if necessary. Plain water may be used if washer fluid is not available. However, use washer solvent with antifreeze characteristics in cold climates to prevent freezing.

⚠ WARNING - Coolant

- Do not use radiator coolant or antifreeze in the washer fluid reservoir.
- Radiator coolant can severely obscure visibility when sprayed on the windshield and may cause loss of vehicle control or damage to paint and body trim.
- Windshield washer fluid agents contain some amounts of alcohol and can be flammable under certain circumstances. Do not allow sparks or flame to contact the washer fluid or the washer fluid reservoir. Damage to the vehicle or occupants could occur.
- Windshield washer fluid is poisonous to humans and animals. Do not drink and avoid contacting windshield washer fluid. Serious injury or death could occur.

HAND BRAKE

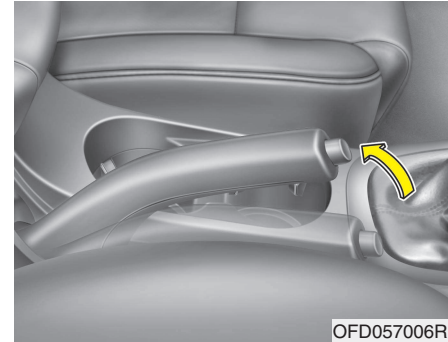

G140100AFD-EA

Checking the hand brake

Check the stroke of the hand brake by counting the number of “clicks” heard while fully applying it from the released position. Also, the hand brake alone should securely hold the vehicle on a fairly steep grade. If the stroke is more or less than specified, have the hand brake adjusted by an authorised HYUNDAI dealer.

Stroke : 7 “clicks” at a force of 20 kg (44 lbs, 196 N).

FUEL FILTER (FOR DIESEL)

G150100AFD-EA

Draining water from fuel filter

The fuel filter for diesel engine plays an important role of separating water from fuel and accumulating the water in its bottom.

If water accumulates in the fuel filter, the warning light comes on when the ignition switch is in the ON position.

If the light is turned on, take your car to the authorised HYUNDAI dealer and have drain the water and checked the system.

CAUTION

If the water accumulated in the fuel filter is not drained at proper times, damages to the major parts such as the fuel system can be caused by water permeation in the fuel filter.

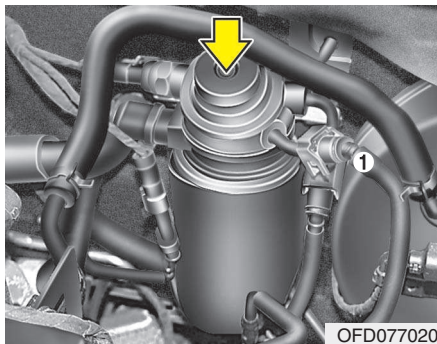

G150200AFD

Fuel filter cartridge replacement

* NOTICE

When replacing the fuel filter cartridge, use HYUNDAI genuine parts.

G150300AFD

Extracting air in the fuel filter (1.6L Diesel engine)

If you drove until you have no fuel left or if you replaced the fuel filter, be sure to extract air in the fuel system as it makes you difficult to start the engine.

1. Disconnect the fuel outlet connector (1) from the fuel filter.
2. Pump up and down until the fuel flows out of the fuel outlet nipple.

* NOTICE

- Use cloths when you extract air so that the fuel is not sprayed around.
- Clean the fuel around the fuel filter or the injection pump before starting the engine to prevent fire.
- Finally, check each part if the fuel is leaking.

AIR CLEANER

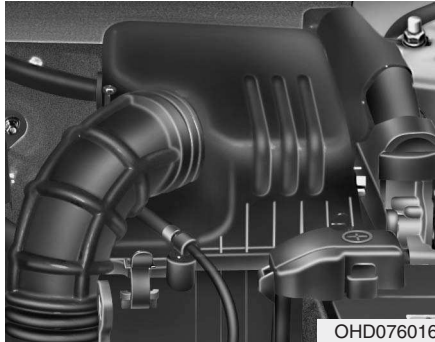

G160100AFD

Filter replacement

It must be replaced when necessary, and should not be cleaned and reused.

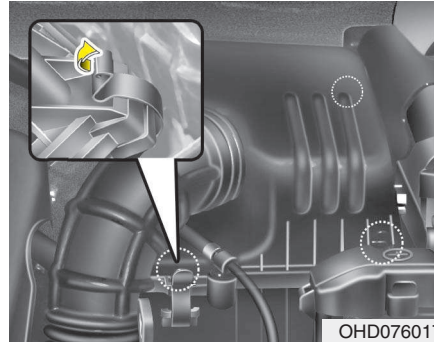

1. Loosen the air cleaner cover attaching clips and open the cover.



2. Replace the air cleaner filter.
3. Lock the cover with the cover attaching clips.

Replace the filter according to the Maintenance Schedule.

If the vehicle is operated in extremely dusty or sandy areas, replace the element more often than the usual recommended intervals. (Refer to "Maintenance under severe usage conditions" in this section.)

CAUTION

- **Do not drive with the air cleaner removed; this will result in excessive engine wear.**
- **When removing the air cleaner filter, be careful that dust or dirt does not enter the air intake, or damage may result.**
- **Use a HYUNDAI genuine part. Use of nongenuine part could damage the air flow sensor or turbo charger.**

CLIMATE CONTROL AIR FILTER (IF EQUIPPED)

G170100AFD

Filter inspection

If the vehicle is operated in the severely air-polluted cities or on dusty rough roads for a long period, it should be inspected more frequently and replaced earlier. When you, the owner, replace the climate control air filter, replace it performing the following procedure, and be careful to avoid damaging other components.

Replace the filter according to the maintenance Schedule.

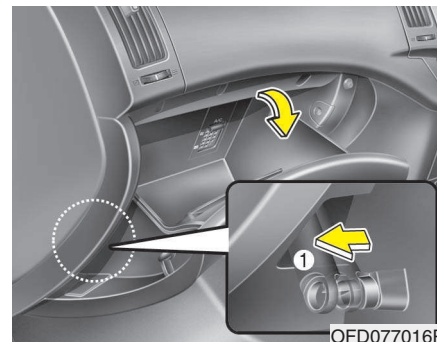

Filter replacement

1. Open the glove box and remove the support rod.

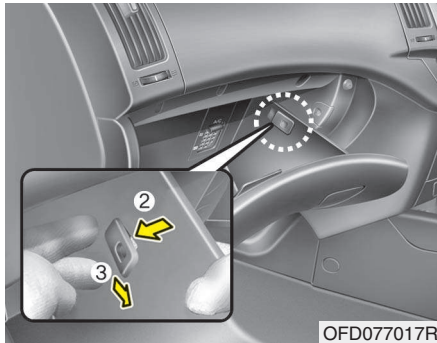

2. With the glove box open, remove the stoppers on both sides to allow the glove box hang freely on the hinges.

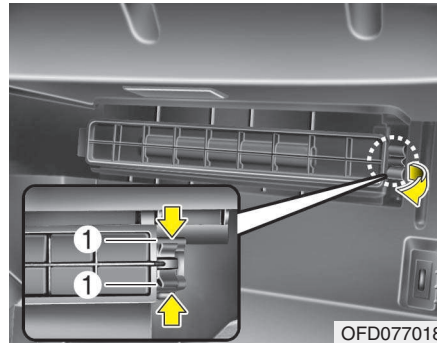

3. Remove the climate control air filter case pulling out the cover.

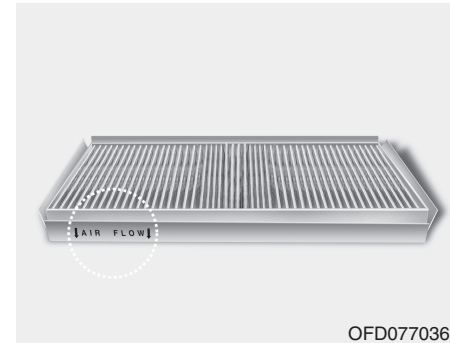

4. Replace the climate control air filter.
5. Reassemble in the reverse order of disassembly.

*** NOTICE**

When replacing the climate control air filter install it according to the “↓AIR FLOW↓” identification marks. Otherwise, the system may produce noise and the effectiveness of the filter may be reduced.

WIPER BLADES

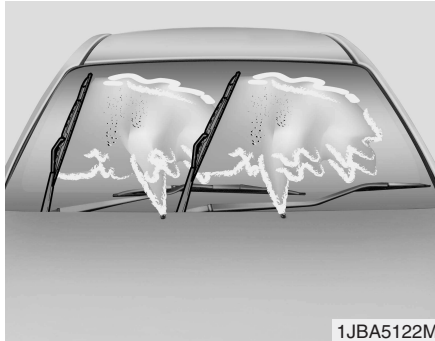

G180100AUN-EA

Blade inspection

* NOTICE

Commercial hot waxes applied by automatic car washes have been known to make the windshield difficult to clean.

Contamination of either the windshield or the wiper blades with foreign matter can reduce the effectiveness of the windshield wipers. Common sources of contamination are insects, tree sap, and hot wax treatments used by some commercial car washes. If the blades are not wiping properly, clean both the window and the blades with a good cleaner or mild detergent, and rinse thoroughly with clean water.

CAUTION

To prevent damage to the wiper blades, do not use petrol, kerosene, paint thinner, or other solvents on or near them.

G180200AUN

Blade replacement

When the wipers no longer clean adequately, the blades may be worn or cracked, and require replacement.

CAUTION

To prevent damage to the wiper arms or other components, do not attempt to move the wipers manually.

CAUTION

The use of a non-specified wiper blade could result in wiper malfunction and failure.

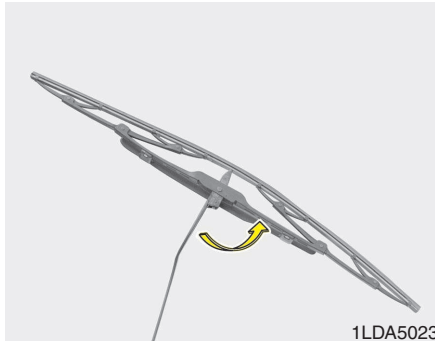

Front windshield wiper blade

Type A

1. Raise the wiper arm and turn the wiper blade assembly to expose the plastic locking clip.

⚠ CAUTION

Do not allow the wiper arm to fall against the windshield, since it may chip or crack the windshield.

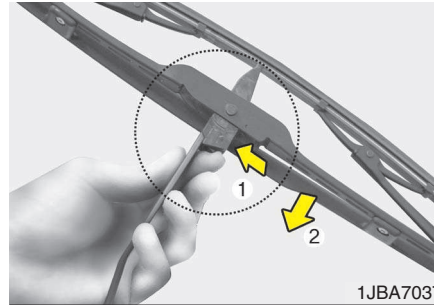

1JBA7037

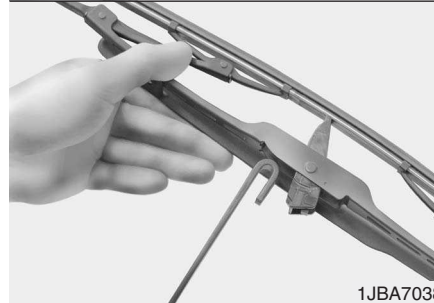

1JBA7038

2. Compress the clip and slide the blade assembly downward.
3. Lift it off the arm.
4. Install the blade assembly in the reverse order of removal.

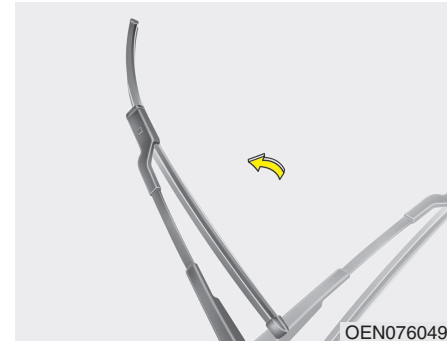

OEN076049

G180201AFD

Type B

1. Raise the wiper arm.

⚠ CAUTION

Do not allow the wiper arm to fall against the windshield, since it may chip or crack the windshield.

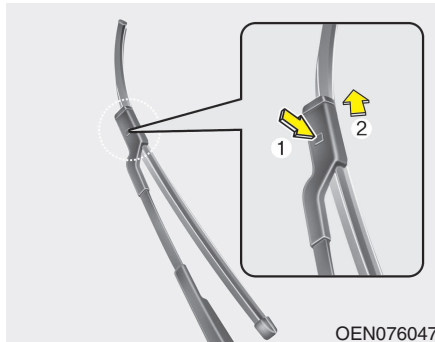

2. Press the button and slide the blade assembly upward.

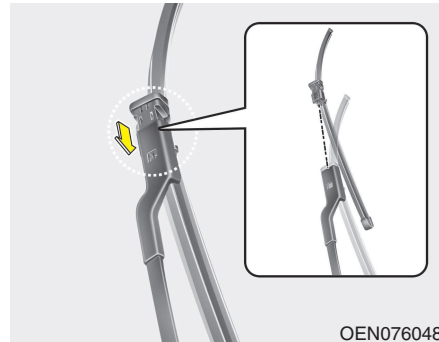

3. Install the blade assembly in the reverse order of removal.
4. Return the wiper arm on the windshield.

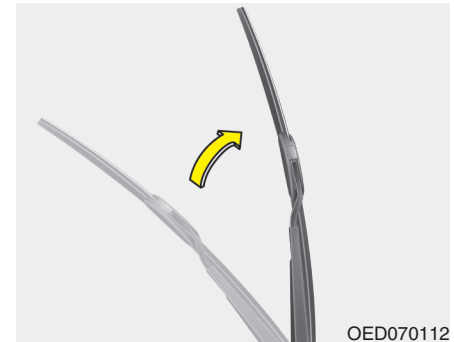

Type C

1. Raise the wiper arm and turn the wiper blade assembly to expose the plastic locking clip.

CAUTION

Do not allow the wiper arm to fall against the windshield, since it may chip or crack the windshield.

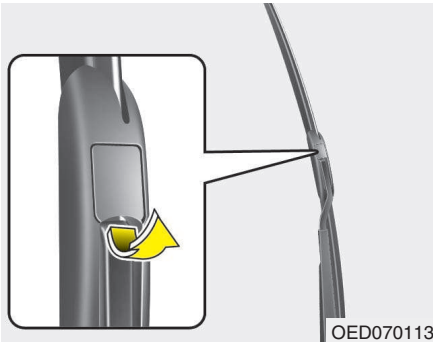

2. Open the cover of the blade.

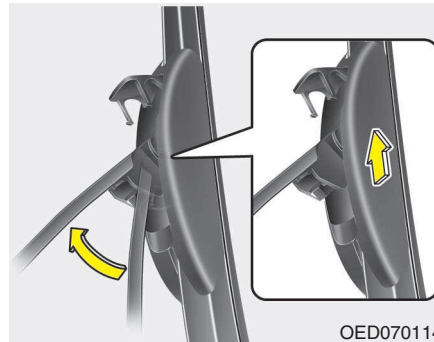

3. Compress the clip behind the wiper arm and lift it off the arm.
4. Install the blade assembly until it clicks into place.
5. Close the cover of blade.
6. Place back the wiper arm to the proper position.

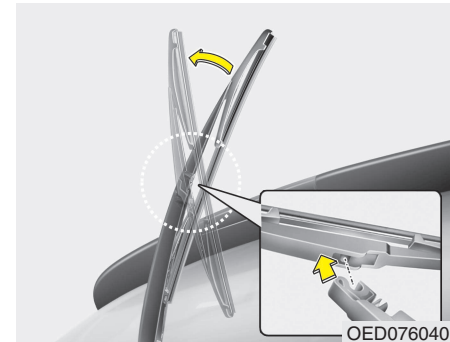

G180202AFD-EA

**Rear window wiper blade
(if equipped)**

1. Raise the wiper arm and pull out the wiper blade assembly.

BATTERY

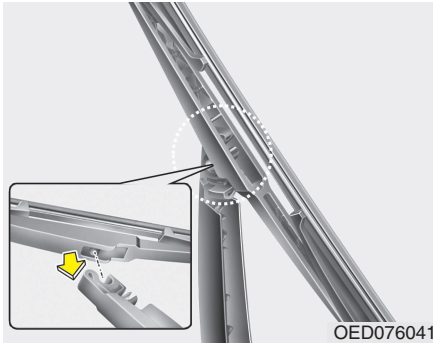

2. Install the new blade assembly by inserting the centre part into the slot in the wiper arm until it clicks into place.
3. Make sure the blade assembly is installed firmly by trying to pull it slightly.

To prevent damage to the wiper arms or other components, have an authorised HYUNDAI dealer replace the wiper blade.

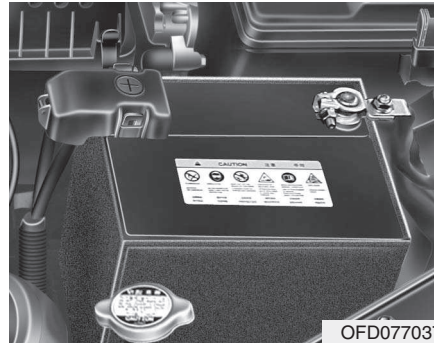

G190100BUN

For best battery service

- Keep the battery securely mounted.
- Keep the battery top clean and dry.
- Keep the terminals and connections clean, tight, and coated with petroleum jelly or terminal grease.
- Rinse any spilled electrolyte from the battery immediately with a solution of water and baking soda.
- If the vehicle is not going to be used for an extended time, disconnect the battery cables.

⚠ WARNING - Battery dangers



Always read the following instructions carefully when handling a battery.



Keep lighted cigarettes and all other flames or sparks away from the battery.



Hydrogen, a highly combustible gas, is always present in battery cells and may explode if ignited.



Keep batteries out of the reach of children because batteries contain highly corrosive **SULFURIC ACID**. Do not allow battery acid to contact your skin, eyes, clothing or paint finish.

(Continued)

(Continued)



If any electrolyte gets into your eyes, flush your eyes with clean water for at least 15 minutes and get immediate medical attention.

If electrolyte gets on your skin, thoroughly wash the contacted area. If you feel a pain or a burning sensation, get medical attention immediately.



Wear eye protection when charging or working near a battery. Always provide ventilation when working in an enclosed space.



An inappropriately disposed battery can be harmful to the environment and human health. Dispose the battery according to your local law(s) or regulation.

(Continued)

(Continued)

- When lifting a plastic-cased battery, excessive pressure on the case may cause battery acid to leak, resulting in personal injury. Lift with a battery carrier or with your hands on opposite corners.
- Never attempt to recharge the battery when the battery cables are connected.
- The electrical ignition system works with high voltage. Never touch these components with the engine running or the ignition switched on.

Failure to follow the above warnings can result in serious bodily injury or death.

VG190200AUN

Battery recharging

Your vehicle has a maintenance-free, calcium-based battery.

- If the battery becomes discharged in a short time (because, for example, the headlights or interior lights were left on while the vehicle was not in use), recharge it by slow charging (trickle) for 10 hours.
- If the battery gradually discharges because of high electric load while the vehicle is being used, recharge it at 20-30A for two hours.

WARNING - Recharging battery

When recharging the battery, observe the following precautions:

- The battery must be removed from the vehicle and placed in an area with good ventilation.
- Do not allow cigarettes, sparks, or flame near the battery.
- Watch the battery during charging, and stop or reduce the charging rate if the battery cells begin gassing (boiling) violently or if the temperature of the electrolyte of any cell exceeds 49°C (120°F).
- Wear eye protection when checking the battery during charging.

(Continued)

(Continued)

- Disconnect the battery charger in the following order.

1. Turn off the battery charger main switch.
 2. Unhook the negative clamp from the negative battery terminal.
 3. Unhook the positive clamp from the positive battery terminal.
- Before performing maintenance or recharging the battery, turn off all accessories and stop the engine.
 - The negative battery cable must be removed first and installed last when the battery is disconnected.

G130300AUN

Reset items

Items should be reset after the battery has been discharged or the battery has been disconnected.

- Auto up/down window (See section 4)
- Sunroof (See section 4)
- Trip computer (See section 4)
- Climate control system (See section 4)
- Clock (See section 4)
- Audio (See section 4)

TYRES AND WHEELS

G200100AUN-EA

Tyre care

For proper maintenance, safety, and maximum fuel economy, you must always maintain recommended tyre inflation pressures and stay within the load limits and weight distribution recommended for your vehicle.

G200200AFD-EA

Recommended cold tyre inflation pressures

All tyre pressures (including the spare) should be checked when the tyres are cold. "Cold Tyres" means the vehicle has not been driven for at least three hours or driven less than 1.6 km (one mile).

Recommended pressures must be maintained for the best ride, top vehicle handling, and minimum tyre wear.

For recommended inflation pressure refer to "Tyre and wheels" in section 9.



All specifications (sizes and pressures) can be found on a label attached to the vehicle.

⚠ WARNING - Tyre underinflation

Severe underinflation (70 kPa (10 psi) or more) can lead to severe heat build-up, causing blowouts, tread separation and other tyre failures that can result in the loss of vehicle control leading to severe injury or death. This risk is much higher on hot days and when driving for long periods at high speeds.

⚠ CAUTION

- *Underinflation also results in excessive wear, poor handling and reduced fuel economy. Wheel deformation also is possible. Keep your tyre pressures at the proper levels. If a tyre frequently needs refilling, have it checked by an authorised HYUNDAI dealer.*
- *Overinflation produces a harsh ride, excessive wear at the centre of the tyre tread, and a greater possibility of damage from road hazards.*

⚠ CAUTION

- *Warm tyres normally exceed recommended cold tyre pressures by 28 to 41 kPa (4 to 6 psi). Do not release air from warm tyres to adjust the pressure or the tyres will be under-inflated.*
- *Be sure to reinstall the tyre inflation valve caps. Without the valve cap, dirt or moisture could get into the valve core and cause air leakage. If a valve cap is missing, install a new one as soon as possible.*

⚠ WARNING - Tyre inflation

Overinflation or underinflation can reduce tyre life, adversely affect vehicle handling, and lead to sudden tyre failure. This could result in loss of vehicle control and potential injury.

⚠ CAUTION - Tyre pressure

Always observe the following:

- *Check tyre pressure when the tyres are cold. (After vehicle has been parked for at least three hours or hasn't been driven more than 1.6 km (one mile) since startup.)*
- *Check the pressure of your spare tyre each time you check the pressure of other tyres.*
- *Never overload your vehicle. Be careful not to overload a vehicle luggage rack if your vehicle is equipped with one.*
- *Worn, old tyres can cause accidents. If your tread is badly worn, or if your tyres have been damaged, replace them.*

G200300AUN-EA

Checking tyre inflation pressure

Check your tyres once a month or more.

Also, check the tyre pressure of the spare tyre.

G200301AFD-EA

How to check

Use a good quality gauge to check tyre pressures. You can not tell if your tyres are properly inflated simply by looking at them. Radial tyres may look properly inflated even when they're underinflated.

Check the tyre's inflation pressure when the tyres are cold. - "Cold" means your vehicle has been sitting for at least three hours or driven no more than 1.6 km (1 mile).

Remove the valve cap from the tyre valve stem. Press the tyre gauge firmly onto the valve to get a pressure measurement. If the cold tyre inflation pressure matches the recommended pressure on the tyre and loading information label, no further adjustment is necessary. If the pressure is low, add air until you reach the recommended amount.

If you overfill the tyre, release air by pushing on the metal stem in the centre of the tyre valve. Recheck the tyre pressure with the tyre gauge. Be sure to put the valve caps back on the valve stems. They help prevent leaks by keeping out dirt and moisture.

⚠ WARNING

- **Inspect your tyres frequently for proper inflation as well as wear and damage. Always use a tyre pressure gauge.**
- **Tyres with too much or too little pressure wear unevenly causing poor handling, loss of vehicle control, and sudden tyre failure leading to accidents, injuries, and even death. The recommended cold tyre pressure for your vehicle can be found in this manual and on the tyre label located on the driver's side centre pillar.**
- **Worn tyres can cause accidents. Replace tyres that are worn, show uneven wear, or are damaged.**
- **Remember to check the pressure of your spare tyre. HYUNDAI recommends that you check the spare every time you check the pressure of the other tyres on your vehicle.**

G200400AUN-EA

Tyre rotation

To equalize tread wear, it is recommended that the tyres be rotated every 12,000 km (7,500 miles) or sooner if irregular wear develops.

During rotation, check the tyres for correct balance.

When rotating tyres, check for uneven wear and damage. Abnormal wear is usually caused by incorrect tyre pressure, improper wheel alignment, out-of-balance wheels, severe braking or severe cornering. Look for bumps or bulges in the tread or side of tyre. Replace the tyre if you find either of these conditions. Replace the tyre if fabric or cord is visible. After rotation, be sure to bring the front and rear tyre pressures to specification and check wheel nut tightness.

Refer to “Tyre and wheels” in section 9.

With a full-size spare tyre (if equipped)

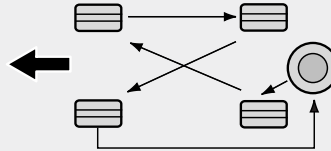

S2BLA790

Without a spare tyre

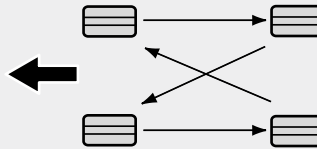

S2BLA790A

Directional tyres (if equipped)

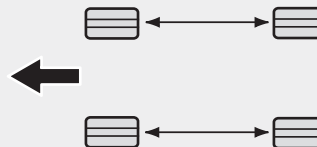

CBGQ0707A

Disc brake pads should be inspected for wear whenever tyres are rotated.

* NOTICE

Rotate radial tyres that have an asymmetric tread pattern only from front to rear and not from right to left.

⚠ WARNING

- Do not use the compact spare tyre for tyre rotation.
- Do not mix bias ply and radial ply tyres under any circumstances. This may cause unusual handling characteristics that could result in death, severe injury, or property damage.

G200500AUN-EA

Wheel alignment and tyre balance

The wheels on your vehicle were aligned and balanced carefully at the factory to give you the longest tyre life and best overall performance.

In most cases, you will not need to have your wheels aligned again. However, if you notice unusual tyre wear or your vehicle pulling one way or the other, the alignment may need to be reset.

If you notice your vehicle vibrating when driving on a smooth road, your wheels may need to be rebalanced.

⚠ CAUTION

Improper wheel weights can damage your vehicle's aluminium wheels. Use only approved wheel weights.



G200600BFD-EA

Tyre replacement

If the tyre is worn evenly, a tread wear indicator will appear as a solid band across the tread. This shows there is less than 1.6 mm (1/16 inch) of tread left on the tyre. Replace the tyre when this happens.

Do not wait for the band to appear across the entire tread before replacing the tyre.

⚠ WARNING - Replacing tyres

- Driving on worn-out tyres is very hazardous and will reduce braking effectiveness, steering accuracy, and traction.
- Your vehicle is equipped with tyres designed to provide for safe ride and handling capability. Do not use a size and type of tyre and wheel that is different from the one that is originally installed on your vehicle. It can affect the safety and performance of your vehicle, which could lead to handling failure or rollover and serious injury. When replacing the tyres, be sure to equip all four tyres with the tyre and wheel of the same size, type, tread, brand and load-carrying capacity.

(Continued)

(Continued)

- The use of any other tyre size or type may seriously affect ride, handling, ground clearance, stopping distance, body to tyre clearance, snow tyre clearance, and speedometer reliability.
- It is best to replace all four tyres at the same time. If that is not possible, or necessary, then replace the two front or two rear tyres as a pair. Replacing just one tyre can seriously affect your vehicle's handling.
- The ABS works by comparing the speed of the wheels. Tyre size can affect wheel speed. When replacing tyres, all 4 tyres must use the same size originally supplied with the vehicle. Using tyres of a different size can cause the ABS (Anti-lock Brake System) and ESP (Electronic Stability Program) (if equipped) to work irregularly.

G200601AUN-EA

Compact spare tyre replacement (if equipped)

A compact spare tyre has a shorter tread life than a regular size tyre. Replace it when you can see the tread wear indicator bars on the tyre. The replacement compact spare tyre should be the same size and design tyre as the one provided with your new vehicle and should be mounted on the same compact spare tyre wheel. The compact spare tyre is not designed to be mounted on a regular size wheel, and the compact spare tyre wheel is not designed for mounting a regular size tyre.

G200700AUN-EA

Wheel replacement

When replacing the metal wheels for any reason, make sure the new wheels are equivalent to the original factory units in diameter, rim width and offset.

 WARNING

A wheel that is not the correct size may adversely affect wheel and bearing life, braking and stopping abilities, handling characteristics, ground clearance, body-to-tyre clearance, snow chain clearance, speedometer and odometer calibration, headlight aim and bumper height.

G200800AUN-EA

Tyre traction

Tyre traction can be reduced if you drive on worn tyres, tyres that are improperly inflated or on slippery road surfaces. Tyres should be replaced when tread wear indicators appear. To reduce the possibility of losing control, slow down whenever there is rain, snow or ice on the road.

G200900AUN-EA

Tyre maintenance

In addition to proper inflation, correct wheel alignment helps to decrease tyre wear. If you find a tyre is worn unevenly, have your dealer check the wheel alignment.

When you have new tyres installed, make sure they are balanced. This will increase vehicle ride comfort and tyre life. Additionally, a tyre should always be rebalanced if it is removed from the wheel.

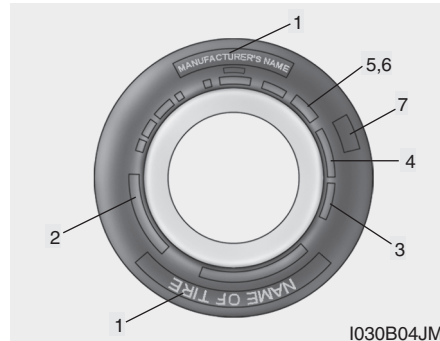

G201000AUN-EA

Tyre sidewall labeling

This information identifies and describes the fundamental characteristics of the tyre and also provides the tyre identification number (TIN) for safety standard certification. The TIN can be used to identify the tyre in case of a recall.

G201001AUN

1. Manufacturer or brand name

Manufacturer or Brand name is shown.

G201002AFD-EA

2. Tyre size designation

A tyre's sidewall is marked with a tyre size designation. You will need this information when selecting replacement tyres for your car. The following explains what the letters and numbers in the tyre size designation mean.

Example tyre size designation:

(These numbers are provided as an example only; your tyre size designator could vary depending on your vehicle.)

205/55R16 91H

205 - Tyre width in millimeters.

55 - Aspect ratio. The tyre's section height as a percentage of its width.

R - Tyre construction code (Radial).

16 - Rim diameter in inches.

91 - Load Index, a numerical code associated with the maximum load the tyre can carry.

H - Speed Rating Symbol. See the speed rating chart in this section for additional information.

Wheel size designation

Wheels are also marked with important information that you need if you ever have to replace one. The following explains what the letters and numbers in the wheel size designation mean.

Example wheel size designation:

6.0JX16

6.0 - Rim width in inches.

J - Rim contour designation.

16 - Rim diameter in inches.

Tyre speed ratings

The chart below lists many of the different speed ratings currently being used for passenger cars. The speed rating is part of the tyre size designation on the sidewall of the tyre. This symbol corresponds to that tyre's designed maximum safe operating speed.

Speed Rating Symbol	Maximum Speed
S	180 km/h (112 mph)
T	190 km/h (118 mph)
H	210 km/h (130 mph)
V	240 km/h (149 mph)
Z	Above 240 km/h (149 mph)

G201003AEN-EA

3. Checking tyre life (TIN : Tyre Identification Number)

Any tyres that are over 6 years, based on the manufacturing date, tyre strength and performance, decline with age naturally (even unused spare tyres). Therefore, the tyres (including the spare tyre) should be replaced by new ones. You can find the manufacturing date on the tyre sidewall (possibly on the inside of the wheel), displaying the DOT Code. The DOT Code is a series of numbers on a tyre consisting of numbers and English letters. The manufacturing date is designated by the last four digits (characters) of the DOT code.

DOT : XXXX XXXX 0000

The front part of the DOT means a plant code number, tyre size and tread pattern and the last four numbers indicate week and year manufactured.

For example:

DOT XXXX XXXX 1610 represents that the tyre was produced in the 16th week of 2010.

⚠ WARNING - Tyre age
 Tyres degrade over time, even when they are not being used. Regardless of the remaining tread, it is recommended that tyres generally be replaced after six (6) years of normal service. Heat caused by not climates or frequent high loading conditions can accelerate the aging process. Failure to follow this Warning can result in sudden tyre failure, which could lead to a loss of control and an accident involving serious injury or death.

G201004AUN-EA

4. Tyre ply composition and material

The number of layers or plies of rubber-coated fabric are in the tyre. Tyre manufacturers also must indicate the materials in the tyre, which include steel, nylon, polyester, and others. The letter "R" means radial ply construction; the letter "D" means diagonal or bias ply construction; and the letter "B" means belted-bias ply construction.

G201005AUN-EA

5. Maximum permissible inflation pressure

This number is the greatest amount of air pressure that should be put in the tyre. Do not exceed the maximum permissible inflation pressure. Refer to the Tyre and Loading Information label for recommended inflation pressure.

G201006AUN-EA

6. Maximum load rating

This number indicates the maximum load in kilograms and pounds that can be carried by the tyre. When replacing the tyres on the vehicle, always use a tyre that has the same load rating as the factory installed tyre.

G201007AUN-EA

7. Uniform tyre quality grading

Quality grades can be found where applicable on the tyre sidewall between tread shoulder and maximum section width.

For example:

TREADWEAR 200
 TRACTION AA
 TEMPERATURE A

Tread wear

The tread wear grade is a comparative rating based on the wear rate of the tyre when tested under controlled conditions on a specified government test course. For example, a tyre graded 150 would wear one-and-a-half times (1½) as well on the government course as a tyre graded 100.

The relative performance of tyres depends upon the actual conditions of their use, however, and may depart significantly from the norm because of variations in driving habits, service practices and differences in road characteristics and climate.

These grades are moulded on the side-walls of passenger vehicle tyres. The tyres available as standard or optional equipment on your vehicles may vary with respect to grade.

Traction - AA, A, B & C

The traction grades, from highest to lowest, are AA, A, B and C. Those grades represent the tyres ability to stop on wet pavement as measured under controlled conditions on specified government test surfaces of asphalt and concrete. A tyre marked C may have poor traction performance.

⚠ WARNING

The traction grade assigned to this tyre is based on straight-ahead braking traction tests, and does not include acceleration, cornering, hydroplaning, or peak traction characteristics.

Temperature -A, B & C

The temperature grades are A (the highest), B and C representing the tyre's resistance to the generation of heat and its ability to dissipate heat when tested under controlled conditions on a specified indoor laboratory test wheel.

Sustained high temperature can cause the material of the tyre to degenerate and reduce tyre life, and excessive temperature can lead to sudden tyre failure. Grades B and A represent higher levels of performance on the laboratory test wheel than the minimum required by the law.

⚠ WARNING - Tyre temperature

The temperature grade for this tyre is established for a tyre that is properly inflated and not overloaded. Excessive speed, underinflation, or excessive loading, either separately or in combination, can cause heat build-up and possible sudden tyre failure. This can cause loss of vehicle control and serious injury or death.

FUSES

Blade type



Normal



Blown

Cartridge type



Normal



Blown

Fusible link



Normal



Blown

1VQA4037

G210000AFD-EA

A vehicle's electrical system is protected from electrical overload damage by fuses.

This vehicle has 2 (or 3) fuse panels, one located in the driver's side panel bolster, the other in the engine compartment near the battery.

If any of your vehicle's lights, accessories, or controls do not work, check the appropriate circuit fuse. If a fuse has blown, the element inside the fuse will be melted.

If the electrical system does not work, first check the driver's side fuse panel. Always replace a blown fuse with one of the same rating.

If the replacement fuse blows, this indicates an electrical problem. Avoid using the system involved and immediately consult an authorised HYUNDAI dealer.

Three kinds of fuses are used: blade type for lower amperage rating, cartridge type, and fusible link for higher amperage ratings.

⚠ WARNING - Fuse replacement

- Never replace a fuse with anything but another fuse of the same rating.
- A higher capacity fuse could cause damage and possibly a fire.
- Never install a wire instead of the proper fuse - even as a temporary repair. It may cause extensive wiring damage and a possible fire.

⚠ CAUTION

Do not use a screwdriver or any other metal object to remove fuses because it may cause a short circuit and damage the system.

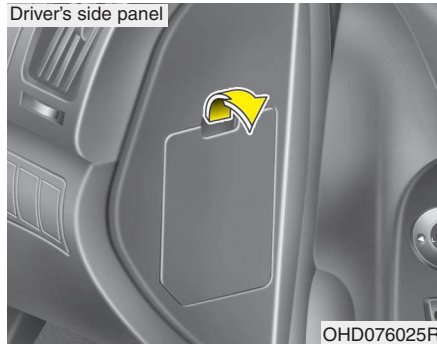

G210100AUN-EA

Inner panel fuse replacement

1. Turn the ignition switch and all other switches off.
2. Open the fuse panel cover.

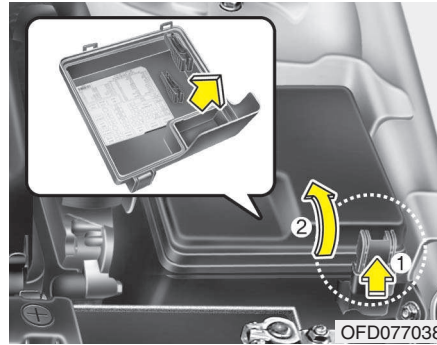

3. Pull the suspected fuse straight out. Use the removal tool provided in the engine compartment fuse panel.
4. Check the removed fuse; replace it if it is blown.
5. Push in a new fuse of the same rating, and make sure it fits tightly in the clips. If it fits loosely, consult an authorised HYUNDAI dealer.

If you do not have a spare, use a fuse of the same rating from a circuit you may not need for operating the vehicle, such as the cigar lighter fuse.

If the headlights or other electrical components do not work and the fuses are OK, check the fuse block in the engine compartment. If a fuse is blown, it must be replaced.

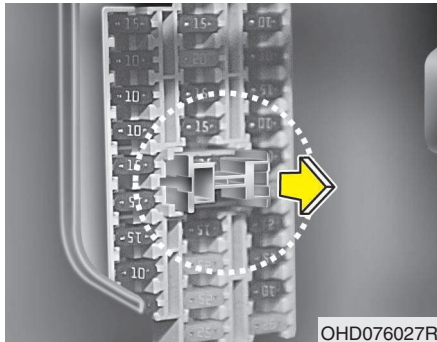

OHD076027R

G210101AUN

Memory fuse

Your vehicle is equipped with the memory fuse to prevent battery discharge if your vehicle is parked without being operated for prolonged periods. Use the following procedures before parking the vehicle for prolonged periods.

1. Turn off the engine.
2. Turn off the headlights and tail lights.
3. Open the driver's side panel cover and pull up the memory fuse.

* NOTICE

- If the memory fuse is pulled up from the fuse panel, the warning chime, audio, clock and interior lamps, etc., will not operate. Some items must be reset after replacement. Refer to "Battery" in this section.
- Even though the memory fuse is pulled up, the battery can still be discharged by operation of the headlights or other electrical devices.

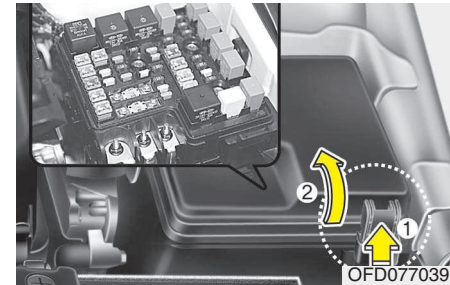

Diesel only

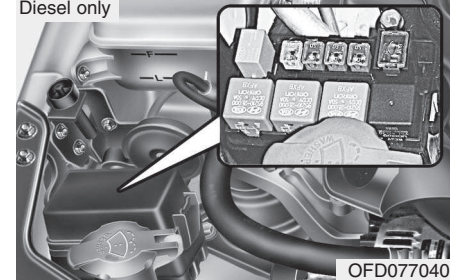

G210200AFD-EA

Engine compartment panel fuse replacement

1. Turn the ignition switch and all other switches off.
2. Remove the fuse box cover by pressing the tap and pulling up.
3. Check the removed fuse; replace it if it is blown. To remove or insert the fuse, use the fuse puller in the engine compartment fuse panel.

4. Push in a new fuse of the same rating, and make sure it fits tightly in the clips. If it fits loosely, consult an authorised HYUNDAI dealer.

CAUTION

After checking the fuse box in the engine compartment, securely install the fuse box cover. If not, electrical failures may occur from water leaking in.



G210201AFD-EA

Main fuse

If the main fuse is blown, it must be removed as follows:

1. Disconnect the negative battery cable.
2. Remove the nuts shown in the picture above.
3. Replace the fuse with a new one of the same rating.
4. Reinstall in the reverse order of removal.

* NOTICE

If the main fuse is blown, consult an authorised HYUNDAI Dealer.

G210300AFD-EA

Fuse/Relay panel description

Inside the fuse/relay box covers, you can find the fuse/relay label describing fuse/relay name and capacity.

Driver's side panel

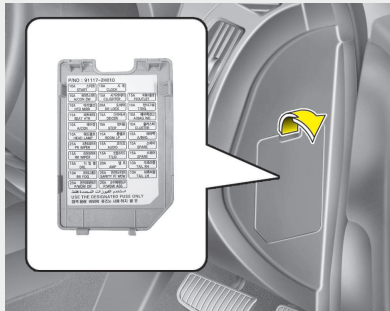

Engine compartment

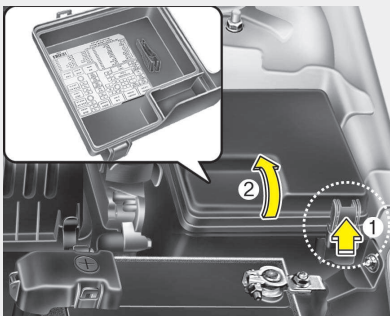

Diesel only

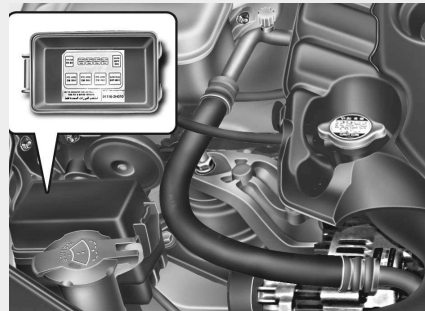

OHD076031R/OFD077041/OFD077042

* NOTICE

Not all fuse panel descriptions in this manual may be applicable to your vehicle. It is accurate at the time of printing. When you inspect the fuse box on your vehicle, refer to the fuse box label.

Driver's side fuse panel

Description	Fuse rating	Protected component
START	10A	Ignition lock switch, Antitheft alarm, Transaxle range switch
A/CON SW	10A	A/C control module
HTD MIRR	10A	Outside heated mirror motor
SEAT HTR	15A	Seat warmer (switch, power)
A/CON	10A	Blower relay, A/C control module, Sunroof control module, Rain sensor
FR FOG	10A	Front fog lamp relay
FR WIPER	25A	Front wiper relay
REAR WIPER	15A	Rear wiper relay
RR FOG	10A	Rear fog lamp relay
P/WDW LH	25A	Front and rear power window switch(LH)
CLOCK	10A	Digital clock, Audio
C/LIGHTER	15A	Power outlet
DR LOCK	20A	Sunroof control module, Door unlock/lock relay
DEICER	15A	Front windshield deicer
STOP	15A	Stop lamp switch
ROOM LP	15A	Boot room lamp, Dome lamp, Map lamp, Digital clock
AUDIO	15A	Audio
T/GATE	15A	Tail gate unlock relay
SAFETY P/WDW RH	25A	Front and rear safety power window switch (RH)
SAFETY P/WDW LH	25A	Front and rear safety power window switch (LH)
P/WDW RH	25A	Front & rear power window switch(RH)
FR P/OUTLET	15A	Power outlet
T/SIG	10A	Hazard switch, Turn signal
A/BAG IND	10A	Airbag indicator(instrument cluster), SBR (passenger, rear)

Description	Fuse rating	Protected component
CLUSTER	10A	Instrument cluster, TPMS
A/BAG	15A	SRS control module
IGN 1	15A	EPS module, ESP switch
HEAD LAMP	15A	Head lamp relay
TAIL RH	10A	Head lamp(RH), Glove box lamp, Rear combination lamp(RH), License lamp
TAIL LH	10A	Head lamp(LH), Power window main switch, Rear combination lamp(LH), License lamp

Engine compartment

	Description	Fuse rating	Protected component
Fusible link	ALTERNATOR	150A	Generator, Fusible link box(D4FB/D4EA)
	MDPS	80A	EPS control module
	ABS.2	20A	ESP control module, ABS control module, Multi purpose check connector
	ABS.1	40A	ESP control module, ABS control module, Multi purpose check connector
	B+.1	50A	Instrument panel junction box
	RR HTD	40A	Instrument panel junction box
	BLOWER	40A	Blower relay
	C/FAN	40A	Condenser fan #1, 2 relay
	B+.2	50A	Instrument panel junction box
	IGN.2	40A	Ignition switch, Start relay
	IGN.1	30A	Ignition switch
Fuse	ECU	30A	Main relay, Powertrain control module(G4GC)
	SPARE.1	20A	(Spare)
	FR FOG	15A	Front fog lamp relay
	A/CON	10A	A/C relay
	HAZARD	15A	Hazard switch, Hazard relay
	F/PUMP	15A	Fuel pump relay
	ECU.1	10A	ECM(G4FC), PCM(G4FC), TCM(D4FB), Generator (D4EA)
	ECU.3	10A	ECM(D4FB/D4EA)
	ECU.4	20A	ECM(D4FB/D4EA)
	INJ	15A	A/C relay, Fuel pump relay, Injector #1,2,3,4(G4FC/G4GC), PCM(G4FC/G4GC), Idle speed actuator(G4FC/G4GC), Immobiliser module(D4FB) etc.
	SNSR.2	10A	Pulse generator 'A', 'B', 'TCM(D4FB), Stop lamp switch(G4FC/G4GC), Vehicle speed sensor etc.
HORN	15A	Horn relay	

Description		Fuse rating	Protected component
Fuse	ABS	10A	ESP control module, ABS control module, Multi purpose check connector
	ECU.2	10A	Ignition coil #1,2,3,4(G4FC), PCM(G4GC)
	B/UP	10A	Back up lamp switch, Transaxle range switch, Cruise control module
	H/LP LO RH	10A	Head lamp(RH), Head lamp leveling actuator(RH)
	H/LP LO LH	10A	Head lamp(LH), Head lamp leveling actuator(LH), Head lamp leveling switch
	H/LP HI	20A	Head lamp Hi relay
	SNSR.1	10A	Immobiliser module(G4FC/G4GC), Stop lamp switch(D4FB), Lambda sensor(D4FB) etc.
	SPARE	10A	(Spare)
	SPARE	15A	(Spare)
SPARE	20A	(Spare)	

Engine compartment (Diesel box)

Description	Fuse rating	Protected component
GLOW PLUG FUSIBLE LINK	80A	Glow plug, Air heater
PTC HEATER #1 FUSIBLE LINK	50A	PTC heater 1
PTC HEATER #2 FUSIBLE LINK	50A	PTC heater 2
PTC HEATER #3 FUSIBLE LINK	50A	PTC heater 3
FUEL FILTER HEATER FUSIBLE LINK	30A	Fuel filter heater
GLOW PLUG RELAY	-	Glow plug relay
PTC HEATER RELAY #1	-	PTC heater relay 1
PTC HEATER RELAY #2	-	PTC heater relay 2
PTC HEATER RELAY #3	-	PTC heater relay 3
FUEL FILTER HEATER RELAY	-	Fuel filter heater relay

LIGHT BULBS

G220000AFD-EA

WARNING - Working on the lights

Prior to working on the light, firmly apply the hand brake, ensure that the ignition switch is turned to the "LOCK" position and turn off the lights to avoid sudden movement of the vehicle and burning your fingers or receiving an electric shock.

Use only the bulbs of the specified wattage.

All bulbs are available from your HYUNDAI dealers Parts Department.

CAUTION

Be sure to replace the burned-out bulb with one of the same wattage rating. Otherwise, it may cause damage to the fuse or electric wiring system.

CAUTION

If you don't have necessary tools, the correct bulbs and the expertise, consult an authorised HYUNDAI dealer. In many cases, it is difficult to replace vehicle light bulbs because other parts of the vehicle must be removed before you can get to the bulb. This is especially true if you have to remove the headlight assembly to get to the bulb(s). Removing/installing the headlight assembly can result in damage to the vehicle.

*** NOTICE**

After heavy, driving rain or washing, headlight and taillight lenses could appear frosty. This condition is caused by the temperature difference between the lamp inside and outside. This is similar to the condensation on your windows inside your vehicle during the rain and doesn't indicate a problem with your vehicle. If the water leaks into the lamp bulb circuitry, have the vehicle checked by an authorised HYUNDAI dealer.



OFD067021

G220100AUN

Headlight, position light, turn signal light, front fog light bulb replacement

- (1) Headlight (High)
- (2) Headlight (Low)
- (3) Position light
- (4) Front turn signal light
- (5) Front fog light (if equipped)

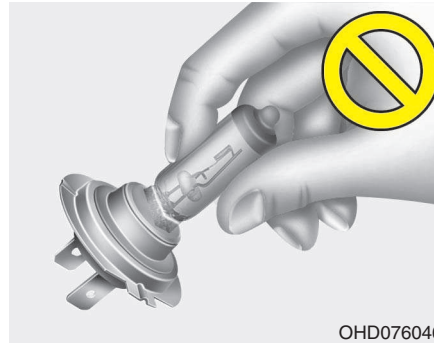

OHD076046

G220101AFD-EA

Headlight bulb

⚠ WARNING - Halogen bulbs

- Halogen bulbs contain pressurized gas that will produce flying pieces of glass if broken.
- Always handle them carefully, and avoid scratches and abrasions. If the bulbs are lit, avoid contact with liquids. Never touch the glass with bare hands. Residual oil may cause the bulb to overheat and burst when lit. A bulb should be operated only when installed in a headlight.

(Continued)

(Continued)

- If a bulb becomes damaged or cracked, replace it immediately and carefully dispose of it.
- Wear eye protection when changing a bulb. Allow the bulb to cool down before handling it.

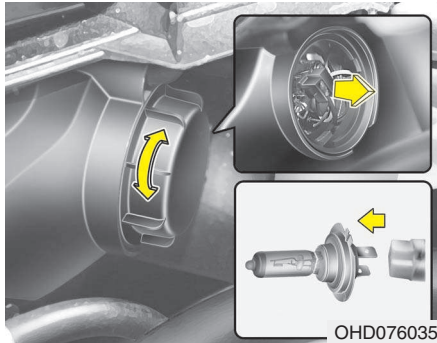

1. Open the bonnet.
2. Remove the headlight assembly by loosening the headlight installation bolts(3EA). (for replacement of low beam bulb)
3. Remove the headlight bulb cover by turning it counterclockwise.
4. Disconnect the headlight bulb socket-connector.
5. Unsnap the headlight bulb retaining wire by depressing the end and pushing it upward.
6. Remove the bulb from the headlight assembly.
7. Install a new headlight bulb and snap the headlight bulb retaining wire into position by aligning the wire with the groove on the bulb.

8. Connect the headlight bulb socket-connector.
9. Install the headlight bulb cover by turning it clockwise.
10. Install the headlight assembly. (for low beam bulb)

* NOTICE

If the headlight aiming adjustment is necessary after the headlight assembly is reinstalled, consult an authorized HYUNDAI dealer.

G220102AFD

Turn signal light/position light, fog light bulb (if equipped)

Turn signal light/position light

1. Remove the headlight assembly by loosening the headlight installation bolts(3EA).
2. Replace the malfunctioned light bulb.
3. Install the headlight assembly.

Fog light bulb

1. Remove the fog light under cover by loosening the screw(2EA).
2. Replace the malfunctioned light bulb.
3. Install the fog light under cover.

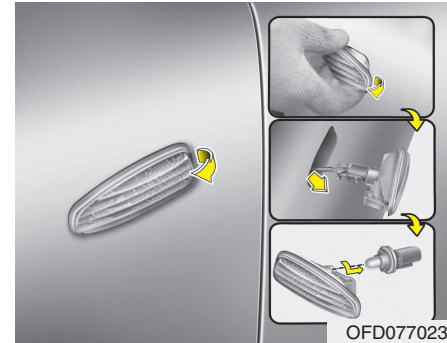

F220200AUN

Side repeater light bulb replacement (if equipped)

1. Remove the light assembly from the vehicle by prying the lens and pulling the assembly out.
2. Disconnect the bulb electrical connector.
3. Separate the socket and the lens parts by turning the socket counterclockwise until the tabs on the socket align with the slots on the lens part.

4. Remove the bulb by pulling it straight out.
5. Insert a new bulb in the socket.
6. Reassemble the socket and the lens part.
7. Connect the bulb electrical connector.
8. Reinstall the light assembly to the body of the vehicle.

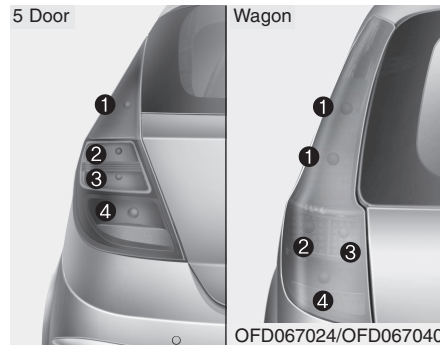

G220300BFD

Rear combination light bulb replacement

5 Door

- (1) Stop and tail light or tail light
- (2) Rear turn signal light
- (3) Back-up light
- (4) Rear fog light (if equipped) or stop light

Wagon

- (1) Tail light
- (2) Rear turn signal light
- (3) Back-up light
- (4) Stop light

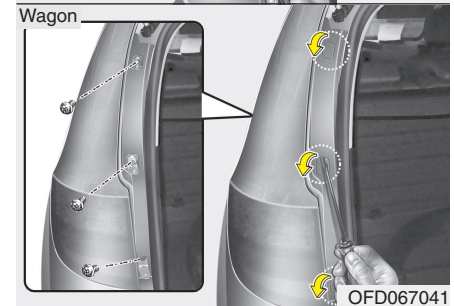
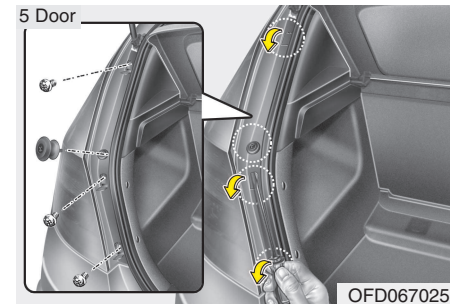

1. Open the tailgate.
2. Loosen the light assembly retaining screws with a cross-tip screwdriver.
3. Remove the rear combination light assembly from the body of the vehicle.

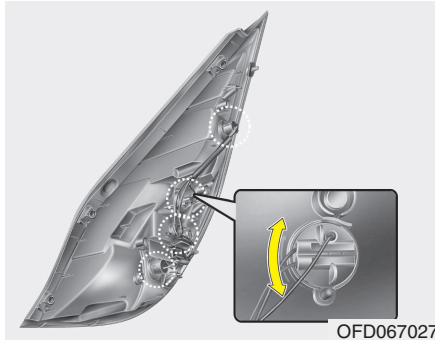

4. Remove the socket from the assembly by turning the socket counterclockwise until the tabs on the socket align with the slots on the assembly.
5. Remove the bulb from the socket by pressing it in and rotating it counterclockwise until the tabs on the bulb align with the slots in the socket. Pull the bulb out of the socket.
6. Insert a new bulb by inserting it into the socket and rotating it until it locks into place.
7. Install the socket in the assembly by aligning the tabs on the socket with the slots in the assembly. Push the socket into the assembly and turn the socket clockwise.
8. Reinstall the light assembly to the body of the vehicle.

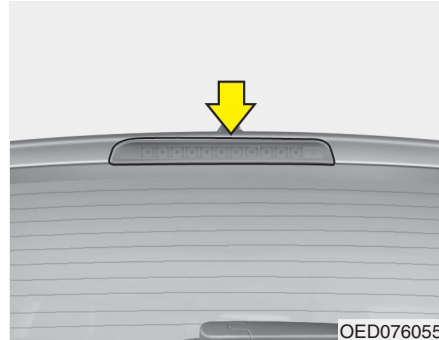

G220400AFD-EA

High mounted stop light replacement

If the light is not operating, have the vehicle checked by an authorised HYUNDAI dealer.

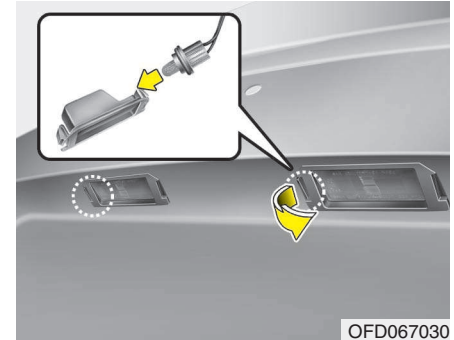

G220400AFD

License plate light bulb replacement

1. Remove the lens by pressing the tabs.
2. Remove the socket from the lens.
3. Remove the bulb by pulling it straight out.
4. Install a new bulb in the socket and install the socket to the lens.
5. Reinstall the lens securely.

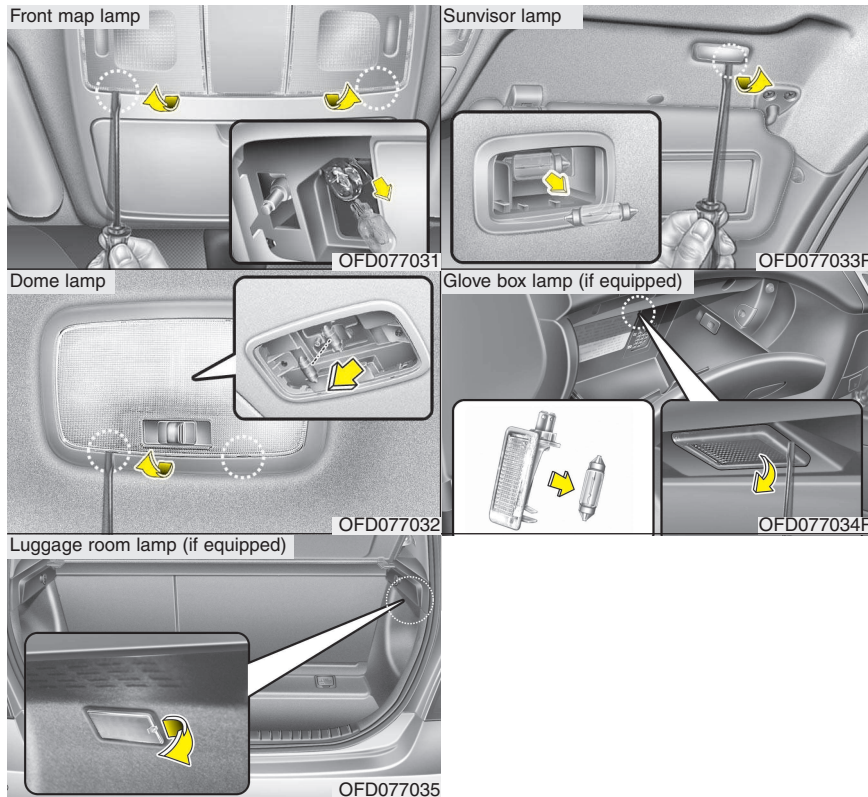

G220600AUN

Interior light bulb replacement

1. Using a flat-blade screwdriver, gently pry the lens from the interior light housing.
2. Remove the bulb by pulling it straight out.

⚠ WARNING

Prior to working on the Interior Lights, ensure that the "OFF" button is depressed to avoid burning your fingers or receiving an electric shock.

3. Install a new bulb in the socket.
4. Align the lens tabs with the interior light housing notches and snap the lens into place.

⚠ CAUTION

Use care not to dirty or damage lens, lens tab, and plastic housings.

APPEARANCE CARE

Exterior care

G230101AUN

Exterior general caution

It is very important to follow the label directions when using any chemical cleaner or polish. Read all warning and caution statements that appear on the label.

G230102DUN-EA

Finish maintenance

Washing

To help protect your vehicle's finish from rust and deterioration, wash it thoroughly and frequently at least once a month with lukewarm or cold water.

If you use your vehicle for off-road driving, you should wash it after each off-road trip. Pay special attention to the removal of any accumulation of salt, dirt, mud, and other foreign materials. Make sure the drain holes in the lower edges of the doors and rocker panels are kept clear and clean.

Insects, tar, tree sap, bird droppings, industrial pollution and similar deposits can damage your vehicle's finish if not removed immediately.

Even prompt washing with plain water may not completely remove all these deposits. A mild soap, safe for use on painted surfaces, may be used.

After washing, rinse the vehicle thoroughly with lukewarm or cold water. Do not allow soap to dry on the finish.

⚠ CAUTION

- ***Do not use strong soap, chemical detergents or hot water, and do not wash the vehicle in direct sunlight or when the body of the vehicle is warm.***
- ***Be careful when washing the side windows of your vehicle. Especially, with high-pressure water. Water may leak through the windows and wet the interior.***
- ***To prevent damage to the plastic parts, do not clean with chemical solvents or strong detergents.***

⚠ WARNING - Wet brakes

After washing the vehicle, test the brakes while driving slowly to see if they have been affected by water. If braking performance is impaired, dry the brakes by applying them lightly while maintaining a slow forward speed.

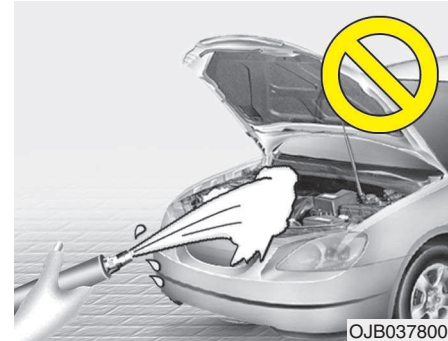

OJB037800

⚠ CAUTION

- ***Water washing in the engine compartment including high pressure water washing may cause the failure of electrical circuits located in the engine compartment.***
- ***Never allow water or other liquids to come in contact with electrical/electronic components inside the vehicle as this may damage them.***

Waxing

Wax the vehicle when water will no longer bead on the paint.

Always wash and dry the vehicle before waxing. Use a good quality liquid or paste wax, and follow the manufacturer's instructions. Wax all metal trim to protect it and to maintain its luster.

Removing oil, tar, and similar materials with a spot remover will usually strip the wax from the finish. Be sure to re-wax these areas even if the rest of the vehicle does not yet need waxing.

**CAUTION**

- *Wiping dust or dirt off the body with a dry cloth will scratch the finish.*
- *Do not use steel wool, abrasive cleaners, or strong detergents containing high alkaline or caustic agents on chrome-plated or anodized aluminium parts. This may result in damage to the protective coating and cause discoloration or paint deterioration.*

G230103AUN

Finish damage repair

Deep scratches or stone chips in the painted surface must be repaired promptly. Exposed metal will quickly rust and may develop into a major repair expense.

*** NOTICE**

If your vehicle is damaged and requires any metal repair or replacement, be sure the body shop applies anti-corrosion materials to the parts repaired or replaced.

B230104AUN

Bright-metal maintenance

- To remove road tar and insects, use a tar remover, not a scraper or other sharp object.
- To protect the surfaces of bright-metal parts from corrosion, apply a coating of wax or chrome preservative and rub to a high luster.
- During winter weather or in coastal areas, cover the bright metal parts with a heavier coating of wax or preservative. If necessary, coat the parts with non-corrosive petroleum jelly or other protective compound.

G230105AUN

Underbody maintenance

Corrosive materials used for ice and snow removal and dust control may collect on the underbody. If these materials are not removed, accelerated rusting can occur on underbody parts such as the fuel lines, frame, floor pan and exhaust system, even though they have been treated with rust protection.

Thoroughly flush the vehicle underbody and wheel openings with lukewarm or cold water once a month, after off-road driving and at the end of each winter. Pay special attention to these areas because it is difficult to see all the mud and dirt. It will do more harm than good to wet down the road grime without removing it. The lower edges of doors, rocker panels, and frame members have drain holes that should not be allowed to clog with dirt; trapped water in these areas can cause rusting.

WARNING

After washing the vehicle, test the brakes while driving slowly to see if they have been affected by water. If braking performance is impaired, dry the brakes by applying them lightly while maintaining a slow forward speed.

G230106AUN-EA

Aluminium wheel maintenance

The aluminium wheels are coated with a clear protective finish.

- Do not use any abrasive cleaner, polishing compound, solvent, or wire brushes on aluminium wheels. They may scratch or damage the finish.
- Use only a mild soap or neutral detergent, and rinse thoroughly with water. Also, be sure to clean the wheels after driving on salted roads. This helps prevent corrosion.
- Avoid washing the wheels with high-speed car wash brushes.
- Do not use any cleaners containing acid or acid detergents. It may damage and corrode the aluminium wheels coated with a clear protective finish.

G230107AUN-EA

Corrosion protection

Protecting your vehicle from corrosion

By using the most advanced design and construction practices to combat corrosion, HYUNDAI produces cars of the highest quality. However, this is only part of the job. To achieve the long-term corrosion resistance your vehicle can deliver, the owner's cooperation and assistance is also required.

Common causes of corrosion

The most common causes of corrosion on your car are:

- Road salt, dirt and moisture that is allowed to accumulate underneath the car.
- Removal of paint or protective coatings by stones, gravel, abrasion or minor scrapes and dents which leave unprotected metal exposed to corrosion.

High-corrosion areas

If you live in an area where your car is regularly exposed to corrosive materials, corrosion protection is particularly important. Some of the common causes of accelerated corrosion are road salts, dust control chemicals, ocean air and industrial pollution.

Moisture breeds corrosion

Moisture creates the conditions in which corrosion is most likely to occur. For example, corrosion is accelerated by high humidity, particularly when temperatures are just above freezing. In such conditions, the corrosive material is kept in contact with the car surfaces by moisture that is slow to evaporate.

Mud is particularly corrosive because it is slow to dry and holds moisture in contact with the vehicle. Although the mud appears to be dry, it can still retain the moisture and promote corrosion.

High temperatures can also accelerate corrosion of parts that are not properly ventilated so the moisture can be dispersed. For all these reasons, it is particularly important to keep your car clean and free of mud or accumulations of other materials. This applies not only to the visible surfaces but particularly to the underside of the car.

To help prevent corrosion

You can help prevent corrosion from getting started by observing the following:

Keep your car clean

The best way to prevent corrosion is to keep your car clean and free of corrosive materials. Attention to the underside of the car is particularly important.

- If you live in a high-corrosion area — where road salts are used, near the ocean, areas with industrial pollution, acid rain, etc.—, you should take extra care to prevent corrosion. In winter, hose off the underside of your car at least once a month and be sure to clean the underside thoroughly when winter is over.

- When cleaning underneath the car, give particular attention to the components under the fenders and other areas that are hidden from view. Do a thorough job; just dampening the accumulated mud rather than washing it away will accelerate corrosion rather than prevent it. Water under high pressure and steam are particularly effective in removing accumulated mud and corrosive materials.
- When cleaning lower door panels, rocker panels and frame members, be sure that drain holes are kept open so that moisture can escape and not be trapped inside to accelerate corrosion.

Keep your garage dry

Don't park your car in a damp, poorly ventilated garage. This creates a favorable environment for corrosion. This is particularly true if you wash your car in the garage or drive it into the garage when it is still wet or covered with snow, ice or mud. Even a heated garage can contribute to corrosion unless it is well ventilated so moisture is dispersed.

Keep paint and trim in good condition

Scratches or chips in the finish should be covered with "touch-up" paint as soon as possible to reduce the possibility of corrosion. If bare metal is showing through, the attention of a qualified body and paint shop is recommended.

Bird droppings : Bird droppings are highly corrosive and may damage painted surfaces in just a few hours. Always remove bird droppings as soon as possible.

Don't neglect the interior

Moisture can collect under the floor mats and carpeting to cause corrosion. Check under the mats periodically to be sure the carpeting is dry. Use particular care if you carry fertilisers, cleaning materials or chemicals in the car.

These should be carried only in proper containers and any spills or leaks should be cleaned up, flushed with clean water and thoroughly dried.

Interior care

G230201BUN

Interior general precautions

Prevent caustic solutions such as perfume and cosmetic oil from contacting the dashboard because they may cause damage or discoloration. If they do contact the dashboard, wipe them off immediately. See the instructions that follow for the proper way to clean vinyl.

 CAUTION

Never allow water or other liquids to come in contact with electrical/electronic components inside the vehicle as this may damage them.

 CAUTION

When cleaning leather products (steering wheel, seats etc.), use neutral detergents or low alcohol content solutions. If you use high alcohol content solutions or acid/alkaline detergents, the color of the leather may fade or the surface may get stripped off.

G230202AUN

Cleaning the upholstery and interior trim**Vinyl**

Remove dust and loose dirt from vinyl with a whisk broom or vacuum cleaner. Clean vinyl surfaces with a vinyl cleaner.

Fabric

Remove dust and loose dirt from fabric with a whisk broom or vacuum cleaner. Clean with a mild soap solution recommended for upholstery or carpets. Remove fresh spots immediately with a fabric spot cleaner. If fresh spots do not receive immediate attention, the fabric can be stained and its color can be affected. Also, its fire-resistant properties can be reduced if the material is not properly maintained.

 CAUTION

Using anything but recommended cleaners and procedures may affect the fabric's appearance and fire-resistant properties.

G230203AUN

Cleaning the lap/shoulder belt webbing

Clean the belt webbing with any mild soap solution recommended for cleaning upholstery or carpet. Follow the instructions provided with the soap. Do not bleach or re-dye the webbing because this may weaken it.

G230204AUN

Cleaning the interior window glass

If the interior glass surfaces of the vehicle become fogged (that is, covered with an oily, greasy or waxy film), they should be cleaned with glass cleaner. Follow the directions on the glass cleaner container.

 CAUTION

Do not scrape or scratch the inside of the rear window. This may result in damage to the rear window defroster grid.

EMISSION CONTROL SYSTEM

G270000AFD-EA

The emission control system of your vehicle is covered by a written limited warranty. Please see the warranty information contained in the Service Passport in your vehicle.

Your vehicle is equipped with an emission control system to meet all Australian Design Rules (ADR) requirements.

There are three emission control systems which are as follows.

- (1) Crankcase emission control system
- (2) Evaporative emission control system
- (3) Exhaust emission control system

In order to assure the proper function of the emission control systems, it is recommended that you have your car inspected and maintained by an authorised HYUNDAI dealer in accordance with the maintenance schedule in this manual.

Caution for the Inspection and Maintenance Test (With Electronic Stability Program (ESP) system)

- **To prevent the vehicle from misfiring during dynamometer testing, turn the Electronic Stability Program (ESP) system off by pressing the ESP switch.**
- **After dynamometer testing is completed, turn the ESP system back on by pressing the ESP switch again.**

G270100AUN

1. Crankcase emission control system

The positive crankcase ventilation system is employed to prevent air pollution caused by blow-by gases being emitted from the crankcase. This system supplies fresh filtered air to the crankcase through the air intake hose. Inside the crankcase, the fresh air mixes with blow-by gases, which then pass through the PCV valve into the induction system.

G270200AFD-EA

2. Evaporative emission control System

The Evaporative Emission Control System is designed to prevent fuel vapours from escaping into the atmosphere.

G270201AUN-EA

Canister

Fuel vapours generated inside the fuel tank are absorbed and stored in the onboard canister. When the engine is running, the fuel vapours absorbed in the canister are drawn into the surge tank through the purge control solenoid valve.

G270202AUN

Purge Control Solenoid Valve (PCSV)

The purge control solenoid valve is controlled by the Engine Control Module (ECM); when the engine coolant temperature is low during idling, the PCSV closes so that evaporated fuel is not taken into the engine. After the engine warms-up during ordinary driving, the PCSV opens to introduce evaporated fuel to the engine.

G270300AUN

3. Exhaust emission control system

The Exhaust Emission Control System is a highly effective system which controls exhaust emissions while maintaining good vehicle performance.

G270301AUN

Vehicle modifications

This vehicle should not be modified. Modification of your vehicle could affect its performance, safety or durability and may even violate governmental safety and emissions regulations.

In addition, damage or performance problems resulting from any modification may not be covered under warranty.

G270302AUN-EA

Engine exhaust gas precautions (carbon monoxide)

- Carbon monoxide can be present with other exhaust fumes. Therefore, if you smell exhaust fumes of any kind inside your vehicle, have it inspected and repaired immediately. If you ever suspect exhaust fumes are coming into your vehicle, drive it only with all the windows fully open. Have your vehicle checked and repaired immediately.



WARNING - Exhaust

Engine exhaust gases contain carbon monoxide (CO). Though colourless and odourless, it is dangerous and could be lethal if inhaled. Follow the instructions following to avoid CO poisoning.

- Do not operate the engine in confined or closed areas (such as garages) any more than what is necessary to move the vehicle in or out of the area.
- When the vehicle is stopped in an open area for more than a short time with the engine running, adjust the ventilation system (as needed) to draw outside air into the vehicle.
- Never sit in a parked or stopped vehicle for any extended time with the engine running.
- When the engine stalls or fails to start, excessive attempts to restart the engine may cause damage to the emission control system.

G270303AFD-EA

Operating precautions for catalytic converters (if equipped)



WARNING - Fire

A hot exhaust system can ignite flammable items under your vehicle. Do not park, idle, or drive the vehicle over or near flammable objects, such as grass, vegetation, paper, leaves, etc.

Your vehicle is equipped with a catalytic converter emission control device.

Therefore, the following precautions must be observed:

- Use only UNLEADED FUEL for petrol engine.
- Do not operate the vehicle when there are signs of engine malfunction, such as misfire or a noticeable loss of performance.
- Do not misuse or abuse the engine. Examples of misuse are coasting with the ignition off and descending steep grades in gear with the ignition off.

- Do not operate the engine at high idle speed for extended periods (5 minutes or more).
- Do not modify or tamper with any part of the engine or emission control system. All inspections and adjustments must be made by an authorised HYUNDAI dealer.
- Avoid driving with a very low fuel level. If you run out of petrol, it could cause the engine to misfire and result in excessive loading of the catalytic converter.

Failure to observe these precautions could result in damage to the catalytic converter and to your vehicle. Additionally, such actions could void your warranty.

Diesel Particulate Filter (if equipped)

The Diesel Particulate Filter (DPF) system removes the soot emitted from the vehicle.

Unlike a disposable air filter, the DPF system automatically burns (oxidizes) and removes the accumulated soot according to the driving condition. In other words, the active burning by engine control system and high exhaust gas temperature caused by normal/high driving condition burns and removes the accumulated soot.

However, if the vehicle continues to be driven at low speed for long time, the accumulated soot may not be automatically removed because of low exhaust gas temperature. In this particular case, the amount of soot is out of detection limit, the soot oxidation process by engine control system may not happen and the malfunction indicator light may blink.

When the malfunction indicator light blinks, it may stop blinking by driving the vehicle at more than 60km/h (37 mph) or at more than second gear with 1500 ~ 2000 engine rpm for a certain time (for about 25 minutes).

If the malfunction indicator light continues to be blinked in spite of the procedure, please visit an authorised HYUNDAI dealer and then check the DPF system.

If you continue to drive with the malfunction indicator light blinking for a long time, the DPF system can be damaged and fuel consumption can be worsen.



CAUTION - Diesel Fuel (if equipped with DPF)

It is recommended to use the regulated automotive diesel fuel for diesel vehicle equipped with the DPF system.

If you use diesel fuel including high sulfur (more than 50 ppm sulfur) and unspecified additives, it can cause the DPF system to be damaged and white smoke can be emitted.

Vehicle identification number (VIN) / 8-2
Tyre specification and pressure label / 8-2
Engine number / 8-3

Consumer information

8

VEHICLE IDENTIFICATION NUMBER (VIN)

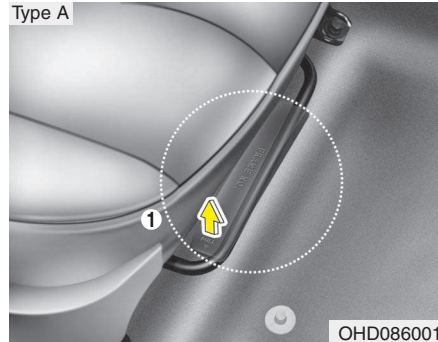

H010000BFD-EA

The vehicle identification number (VIN) is the number used in registering your car and in all legal matters pertaining to its ownership, etc.

The number is punched on the floor under the driver seat. To check the number, open the cover (1).

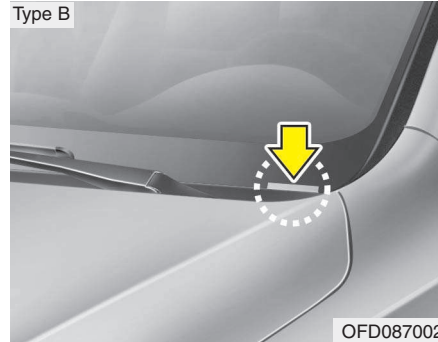

The VIN is also on a plate attached to the top of the dashboard. The number on the plate can easily be seen through the windshield from outside.

TYRE SPECIFICATION AND PRESSURE LABEL

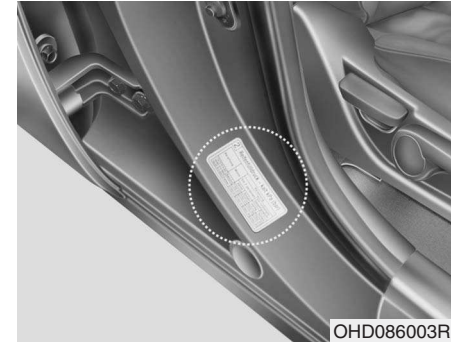

H030000AUN-EA

The tyres supplied on your new vehicle are chosen to provide the best performance for normal driving.

The tyre label located on the driver's side centre pillar gives the tyre pressures recommended for your car.

ENGINE NUMBER

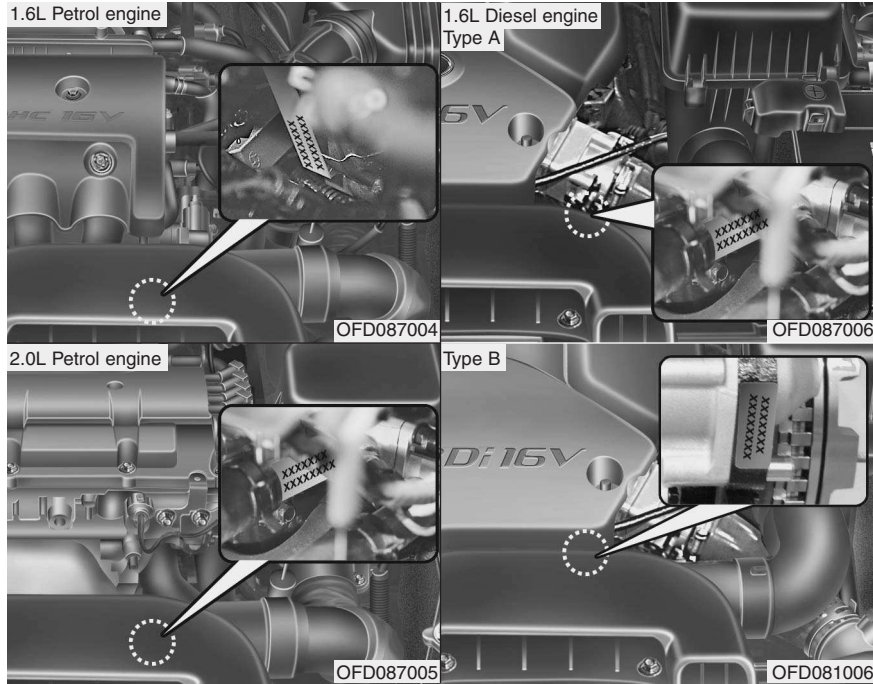

H04000AUN-EE

The engine number is stamped on the engine block as shown in the drawing.

Dimensions / 9-2

Bulb wattage / 9-2

Tyres and wheels / 9-3

Recommended lubricants and capacities / 9-4

Specifications

DIMENSIONS

I010000BFD

mm (in)

Item		5 Door	Wagon
Overall length		4245 (167.1)	4475 (176.2)
Overall width		1775 (69.9)	
Overall height		1480 (58.3)	1520 (59.8)
Front tread	185/65R15	1552/1546 (61.1/60.9)	
	195/65R15	(aluminium/steel)	
	205/55R16	1538 (60.6)	
	225/45R17	1528 (60.2)	
Rear tread	185/65R15	1550/1544 (61.0/60.8)	
	195/65R15	(aluminium/steel)	
	205/55R16	1536 (60.5)	
	225/45R17	1527 (60.1)	
Wheelbase		2650 (104.3)	2700 (106.3)

BULB WATTAGE

I030000BFD-EA

Light Bulb	Wattage
Headlights (Low)	55
Headlights (High)	55
Front turn signal/Position lights	21/5
Side repeater lights*	5
Front fog lights*	27
Rear fog light*	21/5
Stop and tail lights	21/5
Rear turn signal lights	21
Back-up lights	16
High mounted stop light	LED
License plate lights	5
Front map lamps*	10
Centre dome lamps	10
Luggage room lamp*	5
Glove box lamp*	5
Vanity mirror lamps*	5
Side repeater lights* (outside mirror)	LED

* : If equipped

TYRES AND WHEELS

I020000BFD-EA

Item	Tyre size	Wheel size	Inflation pressure kPa (psi)				Wheel lug nut torque kg•m (lb•ft, N•m)
			Normal load *1		Maximum load		
			Front	Rear	Front	Rear	
Full size tyre	185/65R15	5.5J×15	220 (32)	220 (32)	240 (35)	260 (38)	9~11 (65~79 , 88~107)
	195/65R15	5.5J×15					
	205/55R16	6.0J×16					
	225/45R17	7.0J×17					
Compact spare tyre (If equipped)	T125/80D15 95M	4.0T×15	420 (60)	420 (60)	420 (60)	420 (60)	

*1 Normal load : Up to 2 persons

RECOMMENDED LUBRICANTS AND CAPACITIES

I040000BFD-EA

To help achieve proper engine and powertrain performance and durability, use only lubricants of the proper quality. The correct lubricants also help promote engine efficiency that results in improved fuel economy.

These lubricants and fluids are recommended for use in your vehicle.

Lubricant		Volume	Classification	
Engine oil *1 *2 (drain and refill) 	Petrol Engine	1.6L	API Service SM *3, ILSAC GF-4 or above	
		2.0L		4.0 l (4.23 US qt.)
	Diesel Engine	1.6L	5.3 l (5.60 US qt.)	Without CPF ; API Service CH-4 or above, ACEA B4 With CPF (Catalyzed Particulate filter) ; ACEA C3
Engine oil consumption	Normal driving condition		MAX. 1 l /1500 km	-
	Severe driving condition		MAX. 1 l /1000 km	-
Manual transaxle fluid	Petrol Engine 1.6L		1.9 l (2.01 US qt.)	API Service GL-4 (SAE 75W-85, fill for-life)
	Petrol Engine 2.0L/ Diesel Engine 1.6L		2.0 l (2.11 US qt.)	
Automatic transaxle fluid	Petrol Engine 1.6L		6.8 l (7.19 US qt.)	DIAMOND ATF SP-III, SK ATF SP-III
	Petrol Engine 2.0L/ Diesel Engine 1.6L		6.6 l (6.97 US qt.)	

*1: Refer to the recommended SAE viscosity numbers on page 9-6.

*2: Engine oils labeled Energy Conserving Oil are now available. Along with other additional benefits, they contribute to fuel economy by reducing the amount of fuel necessary to overcome engine friction. Often, these improvements are difficult to measure in everyday driving, but in a year's time, they can offer significant cost and energy savings.

*3: If the API service SM engine oil is not available in your country, you are able to use API service SL.

Lubricant		Volume	Classification
Coolant	Petrol Engine	1.6L	MIXTURE, Antifreeze with water (Ethylene glycol base coolant for aluminium radiator)
		2.0L	
	Diesel Engine	1.6L	
Brake/Clutch fluid		0.7~0.8 l (0.7~0.8 US qt.)	FMVSS116 DOT-3 or DOT-4
Fuel		53 l (14 US gal.)	-

I040100AFD-EA

Recommended SAE viscosity number

CAUTION

Always be sure to clean the area around any filler plug, drain plug, or dipstick before checking or draining any lubricant. This is especially important in dusty or sandy areas and when the vehicle is used on unpaved roads. Cleaning the plug and dipstick areas will prevent dirt and grit from entering the engine and other mechanisms that could be damaged.

Engine oil viscosity (thickness) has an effect on fuel economy and cold weather operation (engine start and engine oil flowability). Lower viscosity engine oils can provide better fuel economy and cold weather performance, however, higher viscosity engine oils are required for satisfactory lubrication in hot weather. Using oils of any viscosity other than those recommended could result in engine damage.

When choosing an oil, consider the range of temperature your vehicle will be operated in before the next oil change. Proceed to select the recommended oil viscosity from the chart.

Temperature Range for SAE Viscosity Numbers										
Temperature	°C	-30	-20	-10	0	10	20	30	40	50
	(°F)	-10	0	20	40	60	80	100	120	
Petrol Engine Oil *1								20W-50		
								15W-40		
								10W-30		
								5W-20, 5W-30		
Diesel Engine Oil								15W-40		
								10W-30		
								5W-30		
								0W-30 *2		

*1. For better fuel economy, it is recommended to use the engine oil of a viscosity grade SAE 5W-20 (API SM / ILSAC GF-4). However, if the engine oil is not available in your country, select the proper engine oil using the engine oil viscosity chart.

*2. It is only for extreme cold area and to be restricted by driving condition and area. (Especially, not recommended for sustained high loaded and high speed operation.)

Index

I

A

Air bags3-34
 Air bag warning label.....3-54
 Air bag warning light3-51
 Curtain air bag3-42
 Driver's and passenger's front air bag3-37
 Side air bag.....3-40
 Air cleaner.....7-33
 Alarm system4-6
 Antenna4-101
 Anti-lock brake system (ABS).....5-20
 Appearance care.....7-68
 Exterior care7-68
 Interior care7-73
 Armrest3-8
 Ashtray4-89
 Audio system4-101
 Antenna4-101
 Aux, USB and iPod.....4-93
 Steering wheel audio control4-102
 Automatic climate control system4-73
 Air conditioning4-80
 Automatic heating and air conditioning.....4-75
 Manual heating and air conditioning4-76
 Automatic transaxle5-11
 Ignition key interlock system.....5-15
 Shift lock system.....5-15

B

Barrier net4-95
 Battery.....7-40
 Battery saver function.....4-51
 Before driving5-3
 Bottle holders, see cup holders4-90
 Bonnet4-19
 Brake system5-17
 Anti-lock brake system (ABS).....5-20
 Electronic stability program (ESP)5-22
 Hand brake5-18
 Power brakes5-17
 Brakes/clutch fluid7-28
 Bulb replacement7-62
 Front fog light bulb replacement.....7-64
 Headlight bulb replacement7-63
 High mounted stop light replacement7-66
 Interior light bulb replacement.....7-67
 License plate light bulb replacement7-66
 Position light bulb replacement.....7-64
 Rear combination light bulb replacement7-65
 Side repeater light bulb replacement.....7-64
 Turn signal light bulb replacement7-64
 Bulb wattage9-2

C

Capacities (Lubricants)	9-4
Care	
Exterior care	7-68
Interior care	7-73
Tyre care	7-43
Cargo security screen	4-97
Cargo weight	5-49
Center console storage	4-85
Central door lock switch	4-9
Changing tyres	6-8
Chains	
Tyre chains	5-38
Checking tyre inflation pressure	7-45
Child restraint system	3-26
Anchorage fitting packages system	3-31
ISOFIX system	3-31
Child-protector rear door lock	4-11
Climate control system (Automatic)	4-73
Air conditioning	4-80
Automatic heating and air conditioning	4-75
Manual heating and air conditioning	4-76
Climate control system (Manual)	4-64
Air conditioning	4-69
Climate control air filter	4-71
Heating and air conditioning	4-65
Cigarette lighter	4-89

Climate control air filter	4-71, 7-34
Clock (Digital)	4-92, 4-112, 4-125
Clothes hanger	4-93
Combined instrument, see instrument cluster	4-34
Compact spare tyre	6-13
Compact spare tyre replacement	7-48
Coolant	7-25
Cooling fluid, see engine coolant	7-25
Crankcase emission control system	7-74
Cruise control system	5-27
Cup holder	4-90
Curtain air bag	3-42

D

Dashboard, see instrument cluster	4-34
Dashboard illumination, see instrument panel illumination	4-35
Deadlocks	4-10
Defogging (Windshield)	4-81
Defogging logic (Windshield)	4-83
Defroster	4-63
Front windshield deicer	4-63
Rear window defroster	4-63
Defrosting (Windshield)	4-82
Digital clock	4-92, 4-112, 4-125
Dimensions	9-2
Displays, see instrument cluster	4-34

Index

Display illumination, see instrument panel illumination	4-34
Door locks	4-8
Central door lock switch	4-9
Child-protector rear door lock	4-11
Deadlocks	4-10
Drinks holders, see cup holders	4-90
Driver's air bag	3-37
Driving at night	5-34
Driving in flooded areas	5-35
Driving in the rain	5-35

E

Economical operation	5-31
Electric chromic mirror (ECM)	4-30
Electric power steering (EPS)	4-28
Electronic stability program (ESP)	5-22
Emergency starting	6-4
Jump starting	6-4
Push starting	6-5
Emergency tailgate safety release	4-13
Emergency towing	6-17
Emergency while driving	6-2
Emission control system	7-74
Crankcase emission control system	7-74
Evaporative emission control system	7-74
Exhaust emission control system	7-75

Engine compartment	7-2
Engine coolant	7-25
Engine number	8-3
Engine oil	7-24
Engine overheats	6-6
Engine temperature gauge	4-36
Engine will not start	6-3
Evaporative emission control system	7-74
Exhaust emission control system	7-75
Explanation of scheduled maintenance items	7-21
Exterior care	7-68
Exterior features	4-99
Mounting bracket for roof carrier	4-99
Roof rack	4-99

F

Flat tyre	6-7
Changing tyres	6-8
Compact spare tyre	6-13
Jack and tools	6-7
Removing and storing the spare tyre	6-8
Floor mat anchor(s)	4-94
Fluid	
Automatic transaxle	7-29
Brakes/clutch fluid	7-28
Washer fluid	7-31
Folding the rear seat	3-9

Front fog light bulb replacement7-64
 Front seat adjustment3-4
 Fuel filler lid4-21
 Fuel filter (for diesel).....7-32
 Fuel gauge4-36
 Fuel requirements1-2
 Fuses7-53
 Fuse/relay panel description.....7-57
 Main fuse.....7-56
 Memory fuse7-55

G

Gauge
 Engine temperature gauge.....4-36
 Fuel gauge4-36
 Glassroof, see sunroof4-24
 Glove box4-85

H

Hand brake5-18
 Hand brake inspection7-31
 Hazard warning flasher4-50
 Hazardous driving conditions5-33
 Headlight bulb replacement7-63
 Headlight escort function4-41
 Headlight welcome function4-41

Headrest3-5, 3-7
 Heating and air conditioning4-65
 High mounted stop light replacement.....7-66
 Highway driving5-35
 Horn4-29
 How to use this manual1-2

I

Ignition key interlock system.....5-15
 Immobilizer system.....4-2
 Indicators and warnings4-40
 Indicator symbols on the instrument cluster.....1-6
 Inside rearview mirror4-30
 Instrument cluster4-34
 Engine temperature gauge.....4-36
 Fuel gauge4-36
 Instrument panel illumination4-35
 Odometer/Tripmeter4-37
 Speedometer4-35
 Tachometer4-35
 Trip computer.....4-38
 Warning and indicators4-40
 Instrument panel illumination.....4-35
 Instrument panel overview.....2-3
 Interior care7-73
 Interior features4-89
 Ashtray4-89

Index

Aux, USB and iPod	4-93
Barrier net	4-95
Cargo security screen	4-97
Cigarette lighter	4-89
Clothes hanger	4-93
Cup holder	4-90
Digital clock	4-92, 4-112, 4-125
Floor mat anchor(s)	4-94
Luggage net (holder)	4-94
Power outlet	4-90
Shopping bag holder	4-93
Sunvisor	4-90
Interior light	4-60
Interior light bulb replacement	7-67
Interior overview	2-2
Interlock system	5-15
ISOFIX system	3-31

J

Jack and tools	6-7
Jump starting	6-4

K

Key positions	5-4
Keys	4-2

L

Label	
Air bag warning label	3-54
Tyre sidewall labeling	7-49
Tyre specification and pressure label	8-2
Latch system, see ISOFIX system	3-31
License plate light bulb replacement	7-66
Light bulbs	7-62
Front fog light bulb replacement	7-64
Headlight bulb replacement	7-63
High mounted stop light replacement	7-66
Interior light bulb replacement	7-67
License plate light bulb replacement	7-66
Position light bulb replacement	7-64
Rear combination light bulb replacement	7-65
Side repeater light bulb replacement	7-64
Turn signal light bulb replacement	7-64
Lighting	4-51
Battery saver function	4-51
Headlight escort function	4-51
Headlight welcome function	4-51
Lubricants and capacities	9-4
Luggage box	4-87
Luggage net (holder)	4-94
Luggage rack, see roof rack	4-99
Lumbar support	3-7

M

Main fuse	7-56
Maintenance	
Explanation of scheduled maintenance items	7-21
Maintenance services	7-4
Maintenance under severe usage	
conditions (Diesel)	7-19
Maintenance under severe usage	
conditions (Petrol)	7-13
Normal maintenance schedule (Diesel)	7-15
Normal maintenance schedule (Petrol)	7-9
Owner maintenance	7-6
Scheduled maintenance service	7-8
Tyre maintenance	7-49
Maintenance services	7-4
Manual climate control system	4-64
Air conditioning	4-69
Climate control air filter	4-71
Heating and air conditioning	4-65
Manual heating and air conditioning	4-76
Manual transaxle	5-8
Memory fuse	7-55
Mirrors	4-30
Day/night rearview mirror	4-30
Electric chromic mirror (ECM)	4-30
Inside rearview mirror	4-30
Outside rearview mirror	4-31

Moonroof, see sunroof	4-24
Mounting bracket for roof carrier	4-99
Multibox	4-87

N

Neck restraints, see headrest	3-5, 3-7
-------------------------------------	----------

O

Odometer/Tripmeter	4-37
Oil (Engine)	7-24
Outside rearview mirror	4-31
Overheats	6-6
Owner maintenance	7-6

P

Passenger's front air bag	3-37
Position light bulb replacement	7-64
Power brakes	5-17
Power outlet	4-90
Power window lock button	4-17
Pre-tensioner seat belt	3-19
Push starting	6-5

R

Rear combination light bulb replacement7-65
 Rear seat adjustment3-7
 Rear parking assist system.....4-48
 Recommended cold tyre inflation pressures.....7-43
 Recommended lubricants and capacities9-4
 Recommended SAE viscosity number.....9-5
 Remote keyless entry4-4
 Road warning6-2
 Rocking the vehicle5-33
 Roof rack.....4-99

S

Scheduled maintenance service7-8
 Normal maintenance schedule(Diesel)7-15
 Normal maintenance schedule(Petrol)7-9
 Maintenance under severe usage
 conditions (Diesel)7-19
 Maintenance under severe usage
 conditions (Petrol).....7-13
 Seat belts3-13
 3 point rear center seat belt3-17
 Lap/shoulder belt.....3-15
 Pre-tensioner seat belt3-19
 Seat belt warning3-14
 Seatback pocket3-7

Seats3-2
 Armrest3-8
 Folding the rear seat3-9
 Front seat adjustment3-4
 Headrest3-5, 3-7
 Lumbar support3-7
 Rear seat adjustment3-7
 Seatback pocket3-7
 Shift lock system5-15
 Shopping bag holder4-93
 Side air bag3-40
 Side repeater light bulb replacement7-64
 Smooth cornering5-34
 Snow tyres5-37
 Spare tyre
 Compact spare tyre6-13
 Compact spare tyre replacement7-48
 Removing and storing the spare tyre6-8
 Special driving conditions5-33
 Driving at night5-34
 Driving in flooded areas5-35
 Driving in the rain5-35
 Hazardous driving conditions5-33
 Highway driving5-35
 Rocking the vehicle5-33
 Smooth cornering5-34
 Speedometer4-35
 Starting difficulties, see engine will not start6-3

Starting the engine5-5
 Steering wheel4-28
 Electric power steering4-28
 Horn4-29
 Tilt steering4-28
 Steering wheel audio control4-102
 Storage compartment4-85
 Center console storage4-85
 Glove box4-85
 Luggage box4-87
 Multibox4-87
 Sunglass holder4-86
 Sunroof4-24
 Sunvisor4-90

T

Tachometer4-35
 Tailgate4-12
 Emergency tailgate safety release4-13
 Theft-alarm system4-6
 Tie-down hook6-19
 Tilt steering4-28
 Tyre specification and pressure label8-3
 Tyres and wheels7-43, 9-3
 Checking tyre inflation pressure7-45
 Compact spare tyre replacement7-48
 Recommended cold tyre inflation pressures7-43

Tyre care7-43
 Tyre maintenance7-49
 Tyre replacement7-47
 Tyre rotation7-46
 Tyre sidewall labeling7-49
 Tyre traction7-49
 Wheel alignment and tyre balance7-47
 Wheel replacement7-48
 Towing6-15
 Emergency towing6-17
 Removable towing hook6-16
 Tie-down hook (for flatbed towing)6-19
 Trailer towing5-41
 Transaxle
 Automatic transaxle5-11
 Manual transaxle5-8
 Tripmeter4-37
 Trip computer4-38
 Turn signal light bulb replacement7-64

Index

V

Vehicle run-in process	1-5
Vehicle identification number (VIN)	8-2
Vehicle weight	5-49
Base curb weight	5-49
Cargo weight	5-49
GAW (Gross axle weight)	5-49
GAWR (Gross axle weight rating)	5-49
GVW (Gross vehicle weight)	5-49
GVWR (Gross vehicle weight rating)	5-49

W

Washer fluid	7-31
Waste tray, see ashtray	4-89
Warnings and indicators	4-40
Weight	5-49
Base curb weight	5-49
Cargo weight	5-49
GAW (Gross axle weight)	5-49
GAWR (Gross axle weight rating)	5-49
GVW (Gross vehicle weight)	5-49
GVWR (Gross vehicle weight rating)	5-49
Wheel alignment and tyre balance	7-47
Wheel replacement	7-48
Windows	4-14
Auto down window	4-15

Auto up/down window	4-16
Manual windows	4-18
Power window lock button	4-17
Windshield defrosting and defogging	4-81
Defogging logic	4-83
Winter driving	5-37
Snow tyres	5-37
Tyre chains	5-38
Wiper blades	7-36
Wipers and washers	4-56

Seat / 3-2

Seat belts / 3-13

Child restraint system / 3-26

Airbag-supplemental restraint system / 3-34

Safety system of your vehicle

3

SEAT

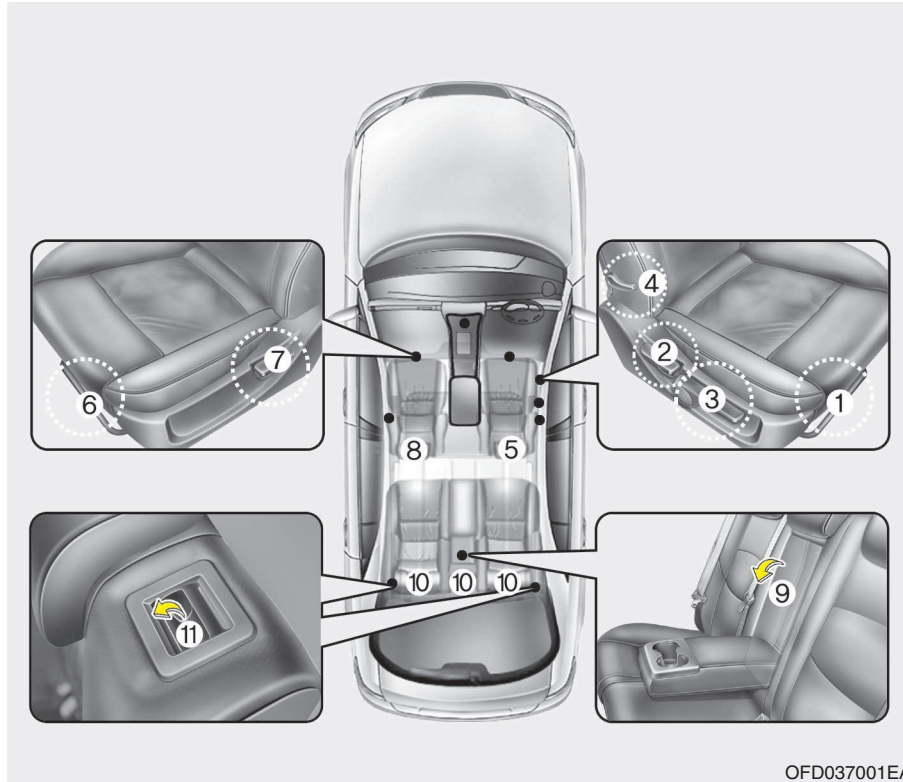

Front seat

- (1) Forward and backward (driver seat)
- (2) Seatback angle (driver seat)
- (3) Seat cushion height (driver seat)*
- (4) Lumbar support (driver seat)*
- (5) Headrest (driver seat)
- (6) Forward and backward (passenger seat)
- (7) Seatback angle (passenger seat)
- (8) Headrest (passenger seat)

Rear seats

- (9) Centre armrest*
- (10) Headrest (outboard and/or centre*)
- (11) Seatback folding lever

* : if equipped

C010000AFD-EA

OFD037001EA

⚠ WARNING - Loose objects
Loose objects in the driver's foot area could interfere with the operation of the foot pedals, possibly causing an accident. Do not place anything under the front seats.

⚠ WARNING - Uprighting seat
When you return the seatback to its upright position, hold the seatback and return it slowly and be sure there are no other occupants around the seat. If the seatback is returned without being held and controlled, the back of the seat could spring forward resulting in accidental injury to a person struck by the seatback.

⚠ WARNING - Driver responsibility for front seat passenger
Riding in a vehicle with a front seatback reclined could lead to serious or fatal injury in an accident. If a front seat is reclined during an accident, the occupant's hips may slide under the lap portion of the seat belt applying great force to the unprotected abdomen. Serious or fatal internal injuries could result. The driver must advise the front passenger to keep the seatback in an upright position whenever the vehicle is in motion.

⚠ WARNING - Driver's seat

- Never attempt to adjust seat while the vehicle is moving. This could result in loss of control, and an accident causing death, serious injury, or property damage.
- Do not allow anything to interfere with the normal position of the seatback. Storing items against a seatback or in any other way interfering with proper locking of a seatback could result in serious or fatal injury in a sudden stop or collision.
- Always drive and ride with your seatback upright and the lap portion of the seat belt snug and low across the hips. This is the best position to protect you in case of an accident.
- In order to avoid unnecessary and perhaps severe air bag injuries, always sit as far back as possible from the steering wheel while maintaining comfortable control of the vehicle. It is recommended that your chest is at least 250 mm (10 inches) away from the steering wheel.

⚠ WARNING

After adjusting the seat, always check that it is securely locked into place by attempting to move the seat forward or reverse without using the lock release lever. Sudden or unexpected movement of the driver's seat could cause you to lose control of the vehicle resulting in an accident.



Front seat adjustment

C010101AUN

Forward and backward

To move the seat forward or backward:

1. Pull the seat slide adjustment lever under the front edge of the seat cushion up and hold it.
2. Slide the seat to the position you desire.
3. Release the lever and make sure the seat is locked in place.

Adjust the seat before driving, and make sure the seat is locked securely by trying to move forward and backward without using the lever. If the seat moves, it is not locked properly.

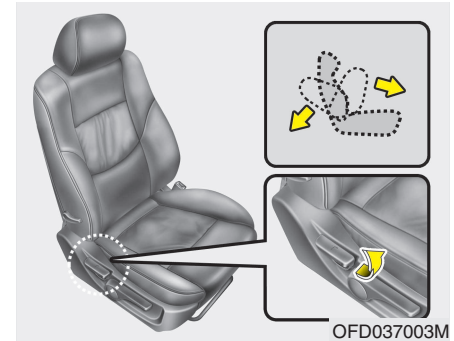

C010102AUN

Seatback angle

To recline the seatback:

1. Lean forward slightly and lift up on the seatback recline lever located on the outside of the seat at the rear.
2. Carefully lean back on the seat and adjust the seatback of the seat to the position you desire.
3. Release the lever and make sure the seatback is locked in place. (The lever **MUST** return to its original position for the seatback to lock.)

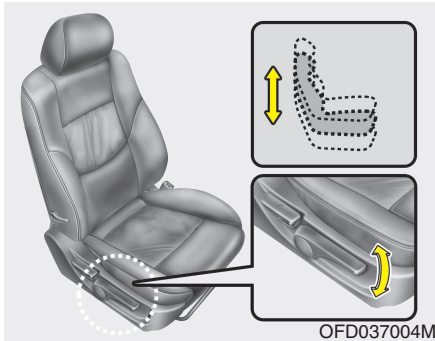

OFD037004M

C010103AUN

Seat cushion height (for driver's seat) (if equipped)

To change the height of the seat cushion, push the lever that is located on the outside of the seat cushion upwards or downwards.

- To lower the seat cushion, push down the lever several times.
- To raise the seat cushion, pull up the lever several times.

C010104AFD

Headrest

The driver's and front passenger's seats are equipped with a headrest for the occupant's safety and comfort.

The headrest not only provides comfort for the driver and front passenger, but also helps to protect the head and neck in the event of a collision.

⚠ WARNING

- For maximum effectiveness in case of an accident, the headrest should be adjusted so the middle of the headrest is at the same height of the center of gravity of an occupant's head. Generally, the center of gravity of most people's head is similar with the height of the top of their eyes. Also, adjust the headrest as close to your head as possible. For this reason, the use of a cushion that holds the body away from the seatback is not recommended.
- Do not operate the vehicle with the headrests removed as severe injury to the occupants may occur in the event of an accident. Headrests may provide protection against neck injuries when properly adjusted.
- Do not adjust the headrest position of the driver's seat while the vehicle is in motion.

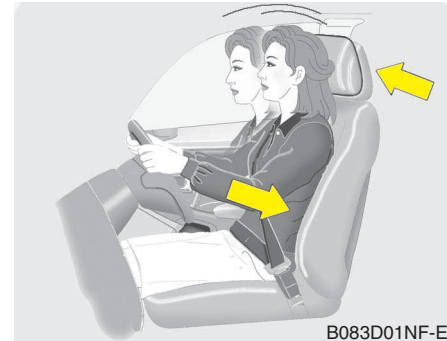

B083D01NF-E

Active headrest (if equipped)

The active headrest is designed to move forward and upward during a rear impact. This helps to prevent the driver's and front passenger's head from moving backward and thus helps prevent neck injuries.

⚠ WARNING

A gap between the seat and the headrest release button may appear when seating on the seat or when you push or pull the seat. Be careful not to get your finger, etc. caught in the gap.

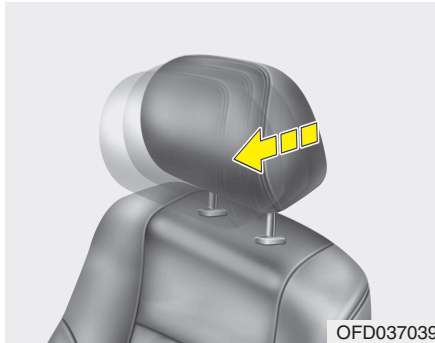

Forward and backward adjustment (if equipped)

The headrest may be adjusted forward to 3 different positions by pulling the headrest forward to the desired detent. To adjust the headrest to its furthest backwards position, pull it fully forward to the farthest position and release it. Adjust the headrest so that it properly supports the head and neck.

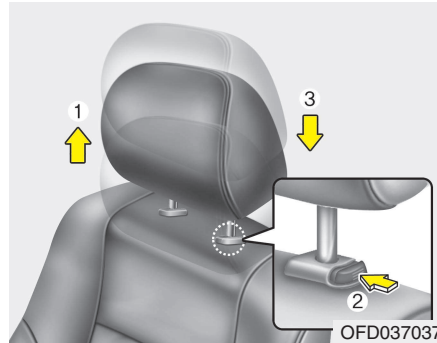

Adjusting the height up and down

To raise the headrest, pull it up to the desired position (1). To lower the headrest, push and hold the release button (2) on the headrest support and lower the headrest to the desired position (3).

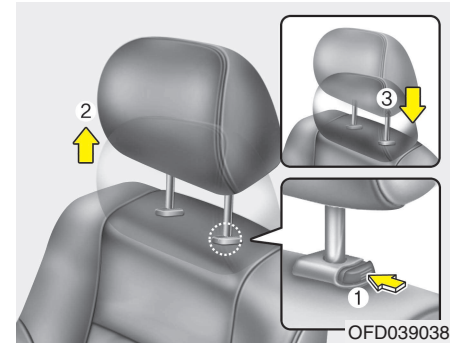

Removal

To remove the headrest, raise it as far as it can go then press the release button (1) while pulling upward (2).

To reinstall the headrest, put the headrest poles (3) into the holes while pressing the release button (1). Then adjust it to the appropriate height.

⚠ WARNING

Make sure the headrest locks in position after adjusting it to properly protect the occupants.

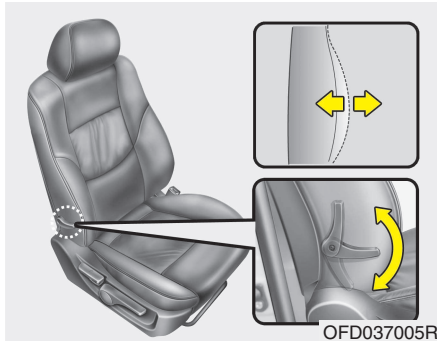

C010105AFD

**Lumbar support
(for driver's seat, if equipped)**

The lumbar support can be adjusted by moving the lever on the outside of the driver's seatback. Pivoting the lever increases or decreases lumbar support.

OFD037005R



C010108AUN

Seatback pocket (if equipped)

The seatback pocket is provided on the back of the front passenger's and driver's seatbacks.

OFD037040

⚠ WARNING - Seatback pockets

Do not put heavy or sharp objects in the seatback pockets. In an accident they could come loose from the pocket and injure vehicle occupants.

Rear seat adjustment

C010303AFD

Headrest

The rear seat is equipped with headrests in all the seating positions for the occupant's safety and comfort.

The headrest not only provides comfort for passengers, but also helps to protect the head and neck in the event of a collision.

⚠ WARNING

- For maximum effectiveness in case of an accident, the headrest should be adjusted so the middle of the headrest is at the same height of the center of gravity of an occupant's head. Generally, the center of gravity of most people's head is similar with the height of the top of their eyes. Also, adjust the headrest as close to your head as possible. The use of a cushion that holds the body away from the seatback is not recommended.
- Do not operate the vehicle with the headrests removed as severe injury to an occupant may occur in the event of an accident. Headrests may provide protection against severe neck injuries when properly adjusted.

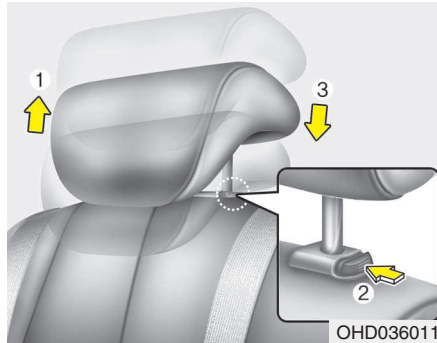

Adjusting the height up and down

To raise the headrest, pull it up to the desired position (1). To lower the headrest, push and hold the release button (2) on the headrest support and lower the headrest to the desired position (3).

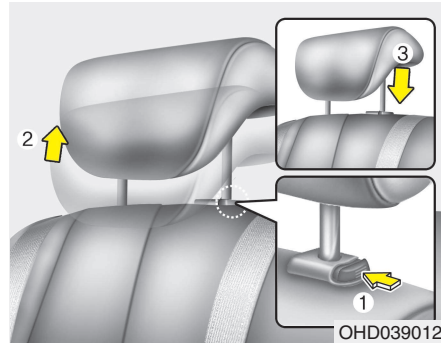

Removal

To remove the headrest, raise it as far as it can go then press the release button (1) while pulling upward (2).

To reinstall the headrest, put the headrest poles (3) into the holes while pressing the release button (1). Then adjust it to the appropriate height.

⚠ WARNING

Make sure the headrest locks in position after adjusting it to properly protect the occupants.



C010304AFD-EA

Armrest (if equipped)

To use the armrest, pull it forward from the seatback.

⚠ CAUTION

- *Make sure the engine is off, the transaxle is in P and the hand brake is applied whenever loading or unloading cargo. Vehicle may move if shift lever is inadvertently moved to another position.*
- *Be careful when loading cargo through the rear passenger seats to prevent damage to the vehicle interior.*
- *When cargo is loaded through the rear passenger seats, ensure the cargo is properly secured to prevent it from moving while driving. Unsecured cargo in the passenger compartment can cause damage to the vehicle or injury to it's occupants.*

C010307BFD-EA

Folding the rear seat

The rear seatbacks (or cushions) may be folded to facilitate carrying long items or to increase the luggage capacity of the vehicle.

⚠ WARNING

The purpose of the fold-down rear seatbacks (or cushions) is to allow you to carry longer objects than could otherwise be accommodated. Never allow passengers to sit on top of the folded down seatback while the car is moving as this is not a proper seating position and no seat belts are available for use. This could result in serious injury or death in case of an accident or a sudden stop. Objects carried on the folded down seatback should not extend higher than the top of the front seats. This could allow cargo to slide forward and cause injury or damage during sudden stops.

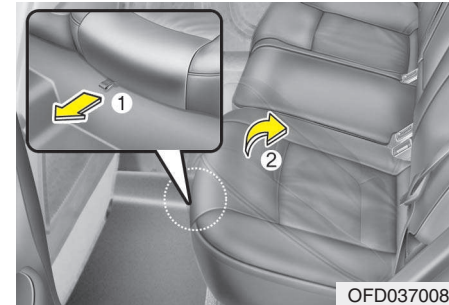

To fold the rear seat cushion and back
- 5 Door

1. Set the front seatback to the upright position and if necessary, slide the front seat forward.
2. Pull the cushion folding strap (1) and lift the front portion of the seat cushion.

Safety system of your vehicle

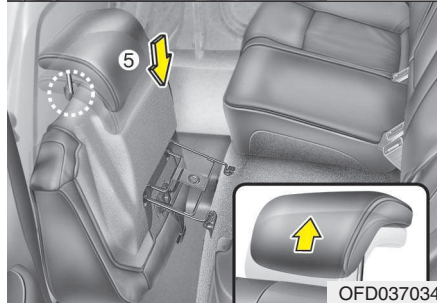
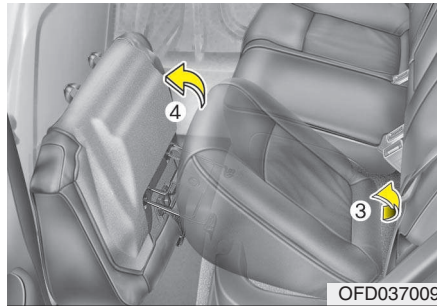

3. Lift the rear portion of the seat cushion. Stand the rear seat cushion vertically.
4. Remove the headrest from the rear seatback.
5. Stow the headrest by inserting the headrest poles into the holder on the bottom of the seat cushion.

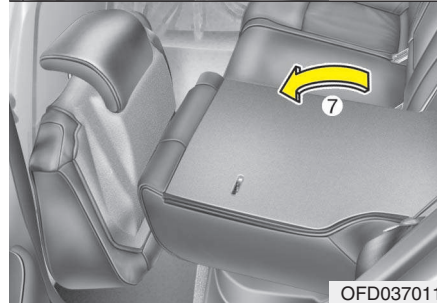
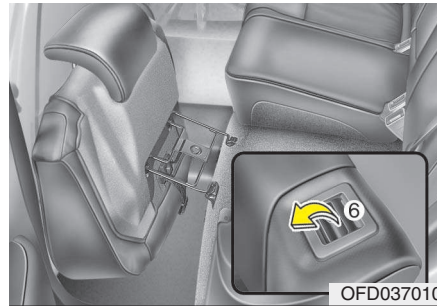

6. Pull the lock release lever (red visible) and fold the rear seatback forward and down firmly.
7. To use the rear seat, lift and push the seatback backward firmly until it clicks into place. Make sure the seatback is locked in place (red invisible).

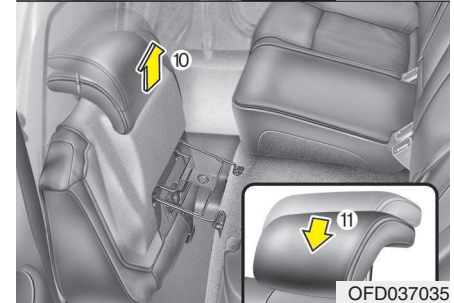
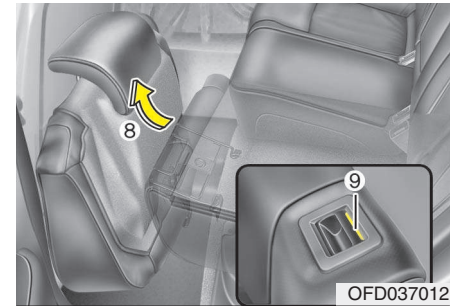

7. To use the rear seat, lift and push the seatback backward firmly until it clicks into place. Make sure the seatback is locked in place (red invisible).
8. Reposition the headrest on the seatback and adjust it to the desired position.

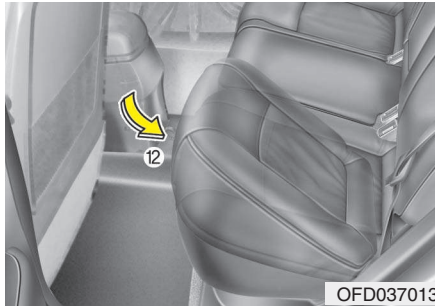

9. Return the seat cushion to the original position by pushing down the rear side of the seat cushion first. Make sure the seat cushion is locked in place.
10. Return the rear seat belt to the proper position.

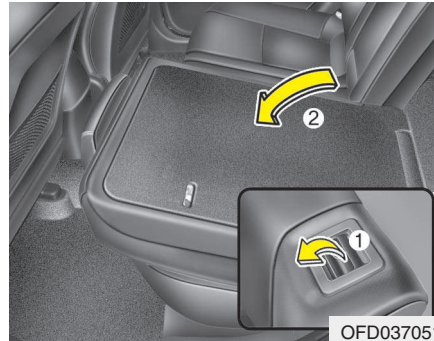

- Wagon

1. Pull the lock release lever (red visible) and fold the rear seatback forward and down firmly.

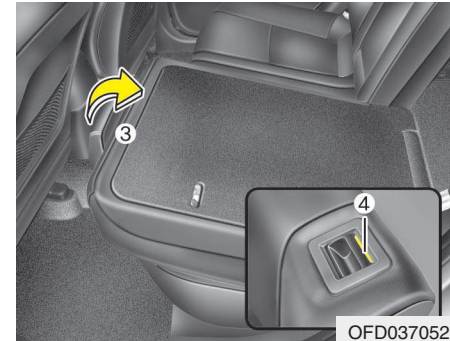

2. To use the rear seat, lift and push the seatback backward firmly until it clicks into place. Make sure the seatback is locked in place (red invisible).
3. Return the rear seat belt to the proper position.

WARNING

When you return the rear seatback to its upright position after being folded down:

Be careful not to damage the seat belt webbing or buckle. Do not allow the seat belt webbing or buckle to get caught or pinched in the rear seat. Ensure that the seatback is completely locked into its upright position by pushing on the top of the seatback. Otherwise, in an accident or sudden stop, the seat could fold down and allow cargo to enter the passenger compartment, which could result in serious injury or death.

CAUTION - Rear seat belts

When returning the rear seatbacks to the upright position, remember to return the rear shoulder belts to their proper position.

WARNING - Cargo

Cargo should always be secured to prevent it from being thrown about the vehicle in a collision and causing injury to the vehicle occupants. Special care should be taken of objects placed in the rear seats, since those may hit the front seat occupants in a frontal collision.

WARNING - Cargo loading

Make sure the engine is off, the transaxle is in P and the hand brake is applied whenever loading or unloading cargo. Failure to take these steps may allow the vehicle to move if shift lever is inadvertently moved to another position.

SEAT BELTS

C020100AUN-EA

Seat belt restraint system

The use of seat belts reduces the risk of accident injury by avoiding collision with the interior of the car and by preventing the occupants from being thrown out of the car. This makes them the most important safety feature available for you and your passengers. Adequate protection is afforded only when the belt is worn correctly. You should always fasten and adjust your seatbelts before the car is put in motion and encourage your passengers to do the same.

WARNING

- For maximum restraint system protection, the seat belts must always be used whenever the car is moving.
- Seat belts are most effective when seatbacks are in the upright position.
- Children age 12 and younger must always be properly restrained in the rear seat. Never allow children to ride in the front passenger seat. If a child over 12 must be seated in the front seat, he/she must be properly belted and the seat should be moved as far back as possible.
- Never wear the shoulder belt under your arm or behind your back. An improperly positioned shoulder belt can cause serious injuries in a crash. The shoulder belt should be positioned midway over your shoulder across your collarbone.

(Continued)

(Continued)

- Avoid wearing twisted seat belts. A twisted belt can't do its job as well. In a collision, it could even cut into you. Be sure the belt webbing is straight and not twisted.
- Be careful not to damage the belt webbing or hardware. If the belt webbing or hardware is damaged, replace it.

WARNING

Seat belts are designed to bear upon the bony structure of the body, and should be worn low across the front of the pelvis or the pelvis, chest and shoulders, as applicable; wearing the lap section of the belt across the abdominal area must be avoided.

Seat belts should be adjusted as firmly as possible, consistent with comfort, to provide the protection for which they have been designed. A slack belt will greatly reduce the protection afforded to the wearer.

(Continued)

(Continued)

Care should be taken to avoid contamination of the webbing with polishes, oils and chemicals, and particularly battery acid. Cleaning may safely be carried out using mild soap and water. The belt should be replaced if webbing becomes frayed, contaminated or damaged. It is essential to replace the entire assembly after it has been worn in a severe impact even if damage to the assembly is not obvious. Belts should not be worn with straps twisted. Each seat belt assembly must only be used by one occupant; it is dangerous to put a belt around a child being carried on the occupant's lap.

⚠ WARNING

No modifications or additions should be made by the user which will either prevent the seat belt adjusting devices from operating to remove slack, or prevent the seat belt assembly from being adjusted to remove slack.

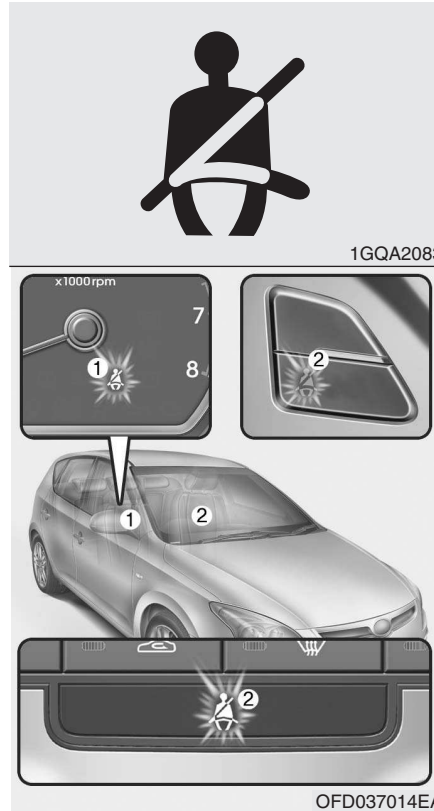

C020101AFD-EA

Seat belt warning

As a reminder to the driver and front passenger, the driver's and front passenger's seat belt warning lights will illuminate for approximately 6 seconds each time you turn the ignition switch ON regardless of belt fastening.

If the driver's or front passenger's seat belt is not fastened when the ignition switch is turned ON or if it is unfastened after the ignition switch is turned ON, the corresponding seat belt warning light will illuminate or blink until the belt is fastened.

If the driver's or front passenger's seat belt is not fastened when the ignition switch is turned ON and you drive over 20 km/h, the seat belt warning chime will sound for approximately 100 seconds.

If the driver's or front passenger's seat belt is unfastened after the ignition switch is turned ON and you drive over 20 km/h, the seat belt warning chime will sound for approximately 100 seconds.

After 100 seconds, if the seat belt is connected and disconnected again, the seat belt warning chime will sound again.

*** NOTICE**

- You can find the front passenger's seat belt warning light on the centre fascia panel.
- Although the front passenger seat is not occupied, the seat belt warning light will blink or illuminate for 6 seconds.
- The front passenger's seat belt warning may operate when luggage is placed on the front passenger seat.

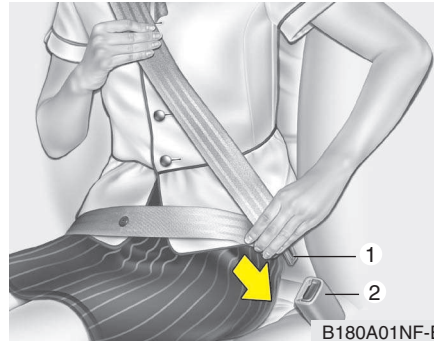

C020102AFD-EA

Lap/shoulder belt

To fasten your seat belt:

To fasten your seat belt, pull it out of the retractor and insert the metal tab (1) into the buckle (2). There will be an audible "click" when the tab locks into the buckle.

The seat belt automatically adjusts to the proper length only after the lap belt portion is adjusted manually so that it fits snugly around your hips. If you lean forward in a slow, easy motion, the belt will extend and let you move around. If there is a sudden stop or impact, however, the belt will lock into position. It will also lock if you try to lean forward too quickly.

*** NOTICE**

If you are not able to pull out the seat belt from the retractor, firmly pull the belt out and release it. Then you will be able to pull the belt out smoothly.

Safety system of your vehicle

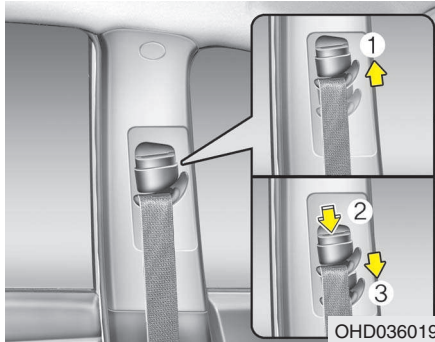

You can adjust the height of the shoulder belt anchor to one of 4 positions for maximum comfort and safety.

If the height of the adjusting seat belt is too near your neck, you will not be getting the most effective protection. The shoulder portion should be adjusted so that it lies across your chest and midway over your shoulder nearest the door and not your neck.

To adjust the height of the seat belt anchor, lower or raise the height adjuster into an appropriate position.

To raise the height adjuster, pull it up (1). To lower it, push it down (3) while pressing the height adjuster button (2).

Release the button to lock the anchor into position. Try sliding the height adjuster to make sure that it has locked into position.

⚠ WARNING

- **Verify the shoulder belt anchor is locked into position at the appropriate height. Never position the shoulder belt across your neck or face. Improperly positioned seat belts can cause serious injuries in an accident.**
- **Failure to replace seat belts after an accident could leave you with damaged seat belts that will not provide protection in the event of another collision leading to personal injury or death. Replace your seat belts after being in an accident as soon as possible.**

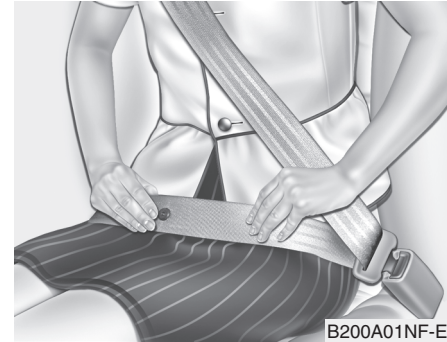

⚠ WARNING

You should place the lap belt portion as low as possible and snugly across your hips, not on your waist. If the lap belt is located too high on your waist, it may increase the chance of injury in the event of a collision. Both arms should not be under or over the belt. Rather, one should be over and the other under, as shown in the illustration. Never wear the seat belt under the arm nearest the door.

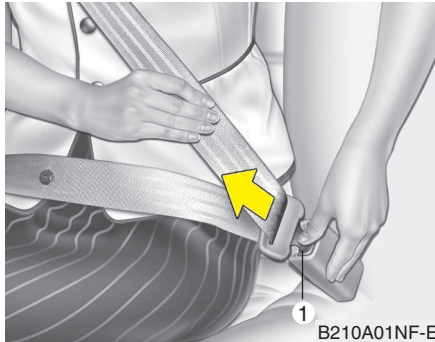

To release the seat belt:

The seat belt is released by pressing the release button (1) in the locking buckle. When it is released, the belt should automatically draw back into the retractor.

If this does not happen, check the belt to be sure it is not twisted, then try again.

If the seat belt does not draw back into the retractor after checking for any twists have the belt inspected by a HYUNDAI dealer.

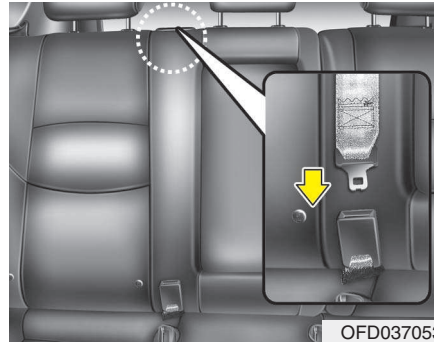

C020104AUN-EA

3-point rear centre seat belt (if equipped)

To fasten the rear centre seat belt:

1. Pull the webbing slowly out from the retractor on the top of the seatback to connect the rear centre belt.

⚠ CAUTION - Cargo

Be sure that cargo is securely loaded in the rear cargo area. Failing to do so may cause damage to the rear centre seat belt in sudden stops or collisions.

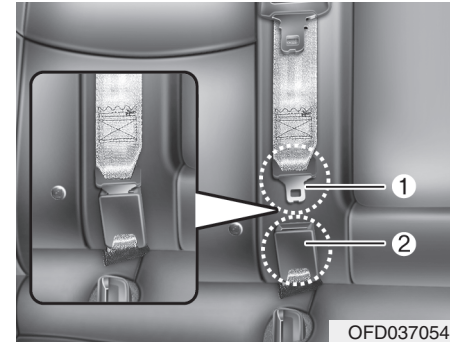

2. Insert the metal tab (1) into the open end of the anchor connector (2) until an audible “click” is heard, indicating the latch is locked. Make sure the belt is not twisted.

Safety system of your vehicle

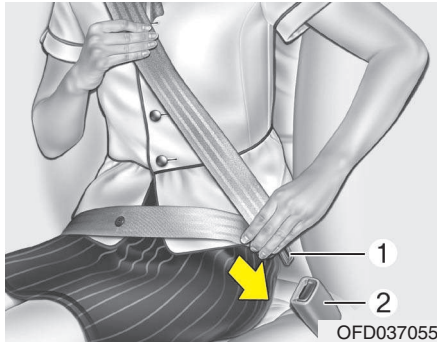

3. Pull the webbing and insert the tongue plate (1) into the open end of the buckle (2) until an audible “click” is heard, indicating the latch is locked. Make sure the belt is not twisted.

There will be an audible “click” when the tab locks in the buckle. The seat belt automatically adjusts to the proper length only after the lap belt is adjusted manually so that it fits snugly around your hips. If you lean forward in a slow, easy motion, the belt will extend and let you move around. If there is a sudden stop or impact, the belt will lock into position. It will also lock if you try to lean forward too quickly.

⚠ WARNING

Never let anyone ride in the rear centre seat without fastening all metal tab (or tongue plate) and anchor connector (or buckle) as described in this section. This seat belt is designed to function as a typical 3-point restraint (lap/shoulder belt). Using only the shoulder portion or lap portion of the belt can result in serious or fatal injuries in the event of a collision or sudden stop.

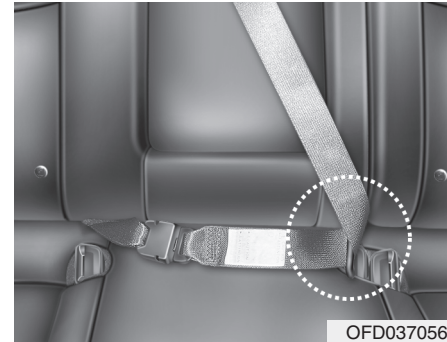

When using the rear centre seat belt, the buckle with the “CENTER” mark must be used.

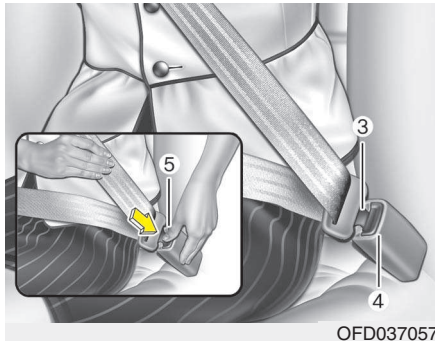

OFD037057

To unfasten the rear centre seat belt:

1. Press the release button (5) on the buckle (4) and remove the tongue plate (3) from the buckle (4).
2. Allow the webbing to draw back automatically into the retractor.

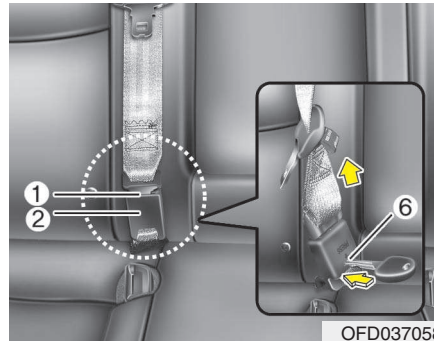

OFD037058

3. If necessary, disconnect the metal tab (1) from the anchor connector (2) by inserting a key or similar small rigid device into the release button (6) on the anchor connector (2) and allow the webbing to draw back automatically into the retractor.



OED030300/H

C020200AFD-EA

Pre-tensioner seat belt (if equipped)

Your vehicle is equipped with driver's and front passenger's pre-tensioner seat belts. The purpose of the pre-tensioner is to make sure that the seat belts fit tightly against the wearer's body in certain frontal collisions. The pre-tensioner seat belts can be activated, where the frontal collision is severe enough, together with the air bags.

When the vehicle stops suddenly, or if the occupant tries to lean forward too quickly, the seat belt retractor will lock into position. In certain frontal collisions, the pre-tensioner will activate and pull the seat belt into tighter contact against the occupant's body.

If the system senses excessive seat belt tension on the driver or passenger's seat belt when the pre-tensioner activates, the load limiter inside the pre-tensioner will release some of the pressure on the affected seat belt. (if equipped)

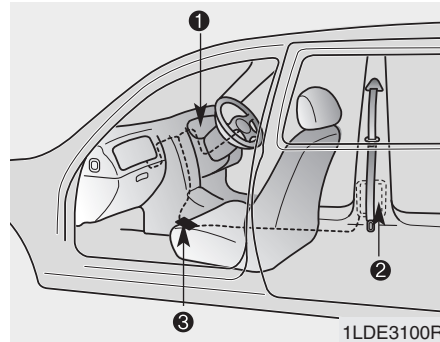

The seat belt pre-tensioner system consists mainly of the following components. Their locations are shown in the illustration:

1. SRS air bag warning light
2. Retractor pre-tensioner assembly
3. SRS control module

⚠ WARNING

To obtain maximum benefit from a pre-tensioner seat belt:

1. The seat belt must be working correctly and adjusted to the proper position. Please read and follow all of the important information and precautions about your vehicle's occupant safety features – including seat belts and air bags – that are provided in this manual.
2. Be sure you and your passengers always wear seat belts properly.

*** NOTICE**

- Both the driver's and front passenger's pre-tensioner seat belts will be activated in certain frontal collisions. The pre-tensioner seat belts can be activated where the frontal collision is severe enough, together with the air bags. The pre-tensioners will not be activated if the seat belts are not being worn at the time of the collision.
- When the pre-tensioner seat belts are activated, a loud noise may be heard and fine dust, which may appear to be smoke, may be visible in the passenger compartment. These are normal operating conditions and are not hazardous.
- Although it is harmless, the fine dust may cause skin irritation and should not be breathed for prolonged periods. Wash all exposed skin areas thoroughly after an accident in which the pre-tensioner seat belts were activated.

*** NOTICE**

Because the sensor that activates the SRS air bag is connected with the pre-tensioner seat belt, the SRS air bag warning light on the instrument panel will illuminate for approximately 6 seconds after the ignition switch has been turned to the "ON" position, and then it should turn off.

⚠ CAUTION

If the pre-tensioner seat belt is not working properly, this warning light will illuminate even if there is no malfunction of the SRS air bag. If the SRS air bag warning light does not illuminate when the ignition key is turned to "ON", or if it remains illuminated after illuminating for approximately 6 seconds, or if it illuminates while the vehicle is being driven, please have an authorised HYUNDAI dealer inspect the pre-tensioner seat belt or SRS air bag system as soon as possible.

⚠ WARNING

- Pre-tensioners are designed to operate only one time. After activation, pre-tensioner seat belts must be replaced. All seat belts, of any type, should always be replaced after they have been worn during a collision.
- The pre-tensioner seat belt assembly mechanisms become hot during activation. Do not touch the pre-tensioner seat belt assemblies for several minutes after they have been activated.
- Do not attempt to inspect or replace the pre-tensioner seat belts yourself. This must be done by an authorised HYUNDAI dealer.
- Do not strike the pre-tensioner seat belt assemblies.
- Improper handling of the pre-tensioner seat belt assemblies, and failure to heed the warnings not to strike, modify, inspect, replace, service or repair the pre-tensioner seat belt assemblies may lead to improper operation or inadvertent activation and serious injury.

(Continued)

(Continued)

- Always wear the seat belts when driving or riding in a motor vehicle.
- If the vehicle or pre-tensioner seat belt must be discarded, contact an authorised Hyundai dealer.

C020300AUN

Seat belt precautions

 WARNING

All occupants of the vehicle must wear their seat belts at all times. Seat belts and child restraints reduce the risk of serious or fatal injuries for all occupants in the event of a collision or sudden stop. Without a seat belt, occupants could be shifted too close to a deploying air bag, strike the interior structure or be thrown from the vehicle. Properly worn seat belts greatly reduce these hazards.

Always follow the precautions about seat belts, air bags and occupant seat contained in this manual.

C020306AUN

Infant or small child

You should be aware of the specific requirements in your country. Child and/or infant seats must be properly placed and installed in the rear seat. For more information about the use of these restraints, refer to “Child restraint system” in this section.

 WARNING

Every person in your vehicle needs to be properly restrained at all times, including infants and children. Never hold a child in your arms or lap when riding in a vehicle. The violent forces created during a crash will tear the child from your arms and throw the child against the interior. Always use a child restraint appropriate for your child's height and weight.

*** NOTICE**

Small children are best protected from injury in an accident when properly restrained in the rear seat by a child restraint system that meets the requirements of the Safety Standards of your country. Before buying any child restraint system, make sure that it has a label certifying that it meets Safety Standards of your country. The restraint must be appropriate for your child's height and weight. Check the label on the child restraint for this information. Refer to “Child restraint system” in this section.

C020301AUN-EA

Larger children

Children who are too large for child restraint systems should always occupy the rear seat and use the available lap/shoulder belts. The lap portion should be fastened snug on the hips and as low as possible. Check belt fit periodically. A child's squirming could put the belt out of position. Children are afforded the most safety in the event of an accident when they are restrained by a proper restraint system in the rear seat. If a larger child (over age 12) must be seated in the front seat, the child should be securely restrained by the available lap/shoulder belt and the seat should be placed in the rearmost position. Children age 12 and under should be restrained securely in the rear seat. NEVER place a child age 12 and under in the front seat. NEVER place a rear facing child seat in the front seat of a vehicle.

If the shoulder belt portion slightly touches the child's neck or face, try placing the child closer to the centre of the vehicle. If the shoulder belt still touches their face or neck they need to be returned to a child restraint system.

⚠ WARNING - Shoulder belts on small children

- Never allow a shoulder belt to be in contact with a child's neck or face while the vehicle is in motion.
- If seat belts are not properly worn and adjusted on children, there is a risk of death or serious injury.

C020302AKM

Restraint of pregnant women

Pregnant women should wear lap/shoulder belt assemblies whenever possible according to specific recommendations by their doctors. The lap portion of the belt should be worn AS SNUGLY AND LOW AS POSSIBLE.

⚠ WARNING - Pregnant women

Pregnant women must never place the lap portion of the safety belt over the area of the abdomen where the fetus is located or above the abdomen where the belt could crush the fetus during an impact.

C020303AUN

Injured person

A seat belt should be used when an injured person is being transported. When this is necessary, you should consult a physician for recommendations.

C020304AUN

One person per belt

Two people (including children) should never attempt to use a single seat belt. This could increase the severity of injuries in case of an accident.

C020305AFD-EA

Do not lie down

To reduce the chance of injuries in the event of an accident and to achieve maximum effectiveness of the restraint system, all passengers should be sitting up and the front seats should be in an upright position when the car is moving. A seat belt cannot provide proper protection if the person is lying down in the rear seat or if the front seat is in a reclined position.

WARNING

Riding with a reclined seatback increases your chance of serious or fatal injuries in the event of a collision or sudden stop. The protection of your restraint system (seat belts and air bags) is greatly reduced by reclining your seat. Seat belts must be snug against your hips and chest to work properly. The more the seatback is reclined, the greater the chance that a wearer's hips will slide under the lap belt causing serious internal injuries or the wearer's neck could strike the shoulder belt. Drivers and passengers should always sit well back in their seats, properly belted, and with the seatbacks upright.

C020400AUN-EA

Care of seat belts

Seat belt systems should never be disassembled or modified. In addition, care should be taken to assure that seat belts and belt hardware are not damaged by seat hinges, doors or other abuse.

WARNING

When you return the rear seatback to its upright position after the rear seatback was folded down, be careful not to damage the seat belt webbing or buckle. Be sure that the webbing or buckle does not get caught or pinched in the rear seat. A seat belt with damaged webbing or buckle will not be as strong and could possibly fail during a collision or sudden stop, resulting in serious injury.

Maintenance of seat belts

When cleaning the seat belts, as recommended, avoid getting solutions into the buckle where they may attack the lubricant or cause corrosion. Do not attempt to bleach or re-dye belts, as this may affect the webbing strength.

*** NOTICE**

Do not attempt any form of modifications or repairs to seat belt components. If the retractor or other components do not operate correctly, call an authorised HYUNDAI dealer, who will take the necessary corrective action. Your authorised dealer will inspect all seat belt components at regular intervals and advise if replacement is required. Between these inspections you should make regular checks to ensure that foreign objects are not preventing complete buckle engagement.

C020401AUN

Periodic inspection

It is recommended that all seat belts be inspected periodically for wear or damage of any kind. Any damaged parts should be replaced as soon as possible.

C020402AUN

Keep belts clean and dry

Seat belts should be kept clean and dry. If belts become dirty, they can be cleaned by using a mild soap solution and warm water. Bleach, dye, strong detergents or abrasives should not be used because they may damage and weaken the fabric.

C020403AFD-EA

When to replace seat belts

Entire in-use seat belt assembly or assemblies should be replaced if the vehicle has been involved in an accident. This should be done even if no damage is visible. Additional questions concerning seat belt operation should be directed to an authorised HYUNDAI dealer.

CHILD RESTRAINT SYSTEM

C030000BUN-EA

Children riding in the car should sit in the rear seat and must always be properly restrained to minimise the risk of injury in an accident, sudden stop or sudden manoeuvre. According to accident statistics, children are safer when properly restrained in the rear seats than in the front seat. Larger children not in a child restraint should use one of the seat belts provided.

If the child is old enough to sit alone and the car is not equipped with a proper child or infant seat, the child should be placed in the rear seat and restrained with a lap/sash belt.

You should be aware of the specific requirements in your country. Child and/or infant safety seats must be properly placed and installed in the rear seat. You must use a commercially available child restraint system that meets the requirements of the Safety Standards of your country. Child restraint systems are designed to be secured in vehicle seats by lap belts or the lap belt portion of a lap/shoulder belt, or by a tether anchor and/or ISOFIX anchors (if equipped).

Children could be injured or killed in a crash if their restraints are not properly secured. For small children and babies, a child seat or infant seat must be used. Before buying a particular child restraint system, make sure it fits your car seat and seat belts, and fits your child.

Follow all the instructions provided by the manufacturer when installing the child restraint system.

WARNING

- **A child restraint system must be placed in the rear seat. Never install a child or infant seat on the front passenger's seat. Should an accident occur and cause the passenger side air bag to deploy, it could severely injure or kill an infant or child seated in an infant or child seat. Thus only use a child restraint in the rear seat of your vehicle.**
- **A seat belt or child restraint system can become very hot if it is left in a closed vehicle on a sunny day, even if the outside temperature does not feel hot. Be sure to check the seat cover and buckles before placing a child there.**
- **When the child restraint system is not in use, store it in the luggage area or fasten it with a seat belt so that it will not be thrown forward in the case of a sudden stop or an accident.**

(Continued)

(Continued)

- **A child restraint system should be placed in the vehicle's rear seat since this can make an important contribution to safety.**
- **Unrestrained children should not be carried in the car. Holding a child in your arms is not a satisfactory substitute for a child restraint system. A child held in this manner can be crushed between your body and the interior of the car.**
- **Children may be seriously injured or killed by an inflating air bag. All children, even those too large for child restraints, must ride in the rear seat.**
- **Before installing Child Restraint System to vehicles fitted with Curtain Airbags, always refer to safety notices for Curtain Airbag systems on this manual. Whenever installing child restraints, use only approved devices and refer to "Child Restraint System" to ensure correct installation and occupant protection is maximised.**

⚠ WARNING

To reduce the chance of serious or fatal injuries:

- Children of all ages are safer when restrained in the rear seat. A child riding in the front passenger seat can be forcefully struck by an inflating air bag resulting in serious or fatal injuries.
- Always follow the instructions for installation and use of the child restraint manufacturer.
- Always make sure the child seat is secured properly in the car and your child is securely restrained in the child seat.
- Never hold a child in your arms or lap when riding in a vehicle. The violent forces created during a crash will tear the child from your arms and throw the child against the car's interior.
- Never put a seat belt over yourself and a child. During a crash, the belt could press deep into the child causing serious internal injuries.

(Continued)

(Continued)

- Never leave children unattended in a vehicle – not even for a short time. The car can heat up very quickly, resulting in serious injuries to children inside. Even very young children may inadvertently cause the vehicle to move, entangle themselves in the windows, or lock themselves or others inside the vehicle.
- Never allow two children, or any two persons, to use the same seat belt.
- Children often squirm and reposition themselves improperly. Never let a child ride with the shoulder belt under their arm or behind their back. Always properly position and secure children in rear seat.
- Never allow a child to stand-up or kneel on the seat or floorboard of a moving vehicle. During a collision or a sudden stop, the child can be violently thrown against the vehicles interior, resulting in serious injury.

(Continued)

(Continued)

- Never use an infant carrier or a child safety seat that "hooks" over a seatback, it may not provide adequate security in an accident.
- Under all circumstances the attaching bolt must be engaged at least 5 full threads in the anchorage. If you are in doubt with any aspect of this installation please contact an authorised HYUNDAI dealer.
- Seat belts can become very hot, especially when the car is parked in direct sunlight. Always check seat belt buckles before fastening them over a child.
- Always store or secure a child seat, even when it is not in use. During a collision or a sudden stop, the child seat could be thrown inside the vehicle.

Rearward-facing child restraint system

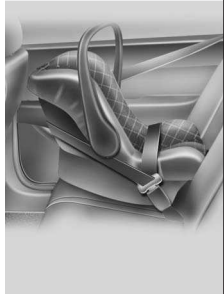

Forward-facing child restraint system



OCM019300

C030100AFD-EA

Using a child restraint system

For small children and babies, the use of a child seat or infant seat is required. This child seat or infant seat should be of appropriate size for the child and should be installed in accordance with the manufacturer's instructions. It is further required that the seat be placed in the vehicle's rear seat. Your vehicle is provided with child restraint anchorage points for installing the child seat or infant seat.

⚠ WARNING

Never place a rear-facing child restraint in the front passenger seat, because of the danger that an inflating passenger-side air bag could impact the rear-facing child restraint and kill the child.

⚠ WARNING - Child seat installation

- Before installing the child restraint system, read the instructions supplied by the child restraint system manufacturer.
- If the seat belt does not operate as described in this section, have the system checked immediately by your authorised HYUNDAI dealer.
- Failure to observe this manual's instructions regarding child restraint system and the instructions provided with the child restraint system could increase the chance and/or severity of injury in an accident.

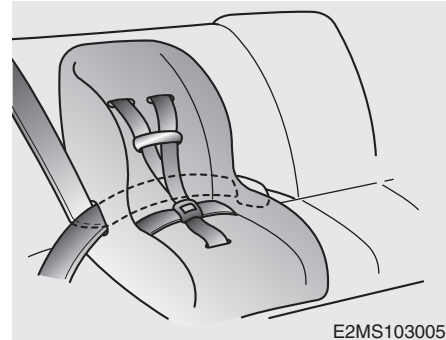

E2MS103005

C030102AUN-EA

Installing a child restraint system by lap/shoulder belt

To install a child restraint system on the outboard or centre rear seats, do the following:

1. Place the child restraint system in the seat and route the lap/shoulder belt around or through the restraint, following the restraint manufacturer's instructions. Be sure the seat belt webbing is not twisted.

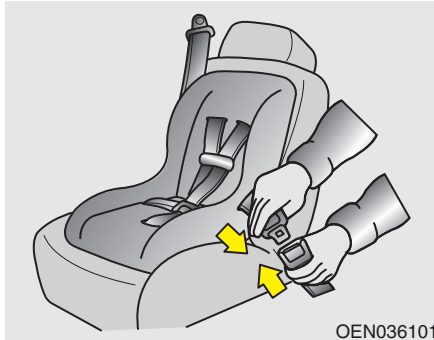

2. Fasten the lap/shoulder belt latch into the buckle. Listen for the distinct “click” sound.

Position the release button so that it is easy to access in case of an emergency.



3. Buckle the seat belt and allow the seat belt to take up any slack. After installation of the child restraint system, try to move it in all directions to be sure the child restraint system is securely installed.

If you need to tighten the belt, pull more webbing toward the retractor. When you unbuckle the seat belt and allow it to retract, the retractor will automatically revert back to its normal seated passenger emergency locking usage condition.

If the child seat moves, readjust the length of the seat belt. In Australia/NZ the child restraint manufacturer's instructions must be followed when fitting the unit to the vehicle.

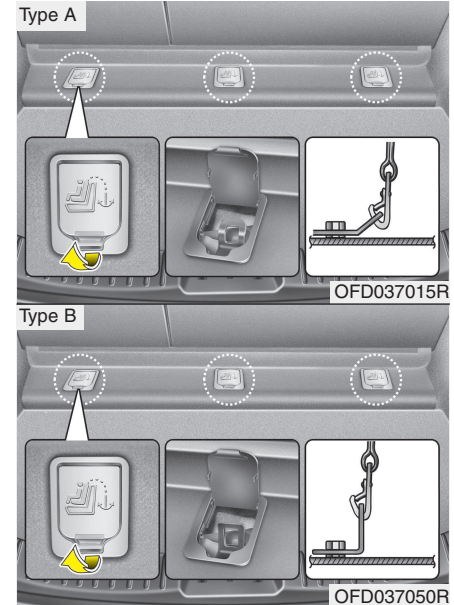

C030103AFD-EA

Securing a child restraint seat with “Anchorage Fitting Packages” system (if equipped)

Child restraint anchorage fitting packages are located on the floor behind the rear seats.

Safety system of your vehicle

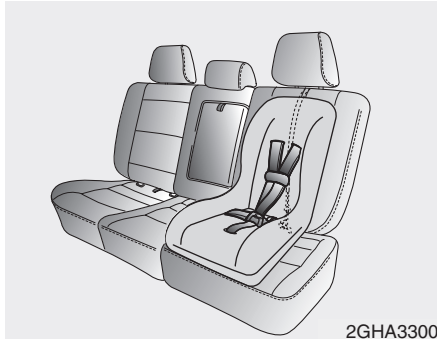

1. Route the child restraint seat strap over the seatback.
For vehicles with adjustable headrest, route the tether strap under the headrest and between the headrest posts, otherwise route the tether strap over the top of the seatback.
2. Connect the attaching clip to the appropriate child restraint hook holder and tighten to secure the seat.

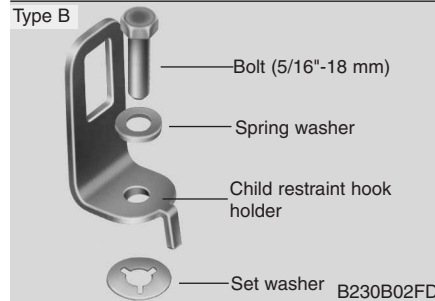
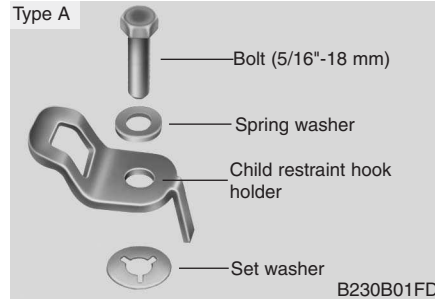

The anchor fitting package consists of:

- Bolt: 5/16 inch - 18 unc
18 mm thread length
- Spring washer : 1.5 mm thickness
- Set washer: 1 mm thickness
- Anchor fitting: Comforms to ADR 34/01

⚠ WARNING

A child can be seriously injured or killed in a collision if the child restraint is not properly anchored to the car and the child is not properly restrained in the child restraint. Always follow the child seat manufacturer's instructions for installation and use.

⚠ WARNING - Tether strap

Never mount more than one child restraint to a single tether or to a single lower anchorage point. The increased load caused by multiple seats may cause the tethers or anchorage points to break, causing serious injury or death.

⚠ WARNING - Child restraint check

Check that the child restraint system is secure by pushing and pulling it in different directions. Incorrectly fitted child restraints may swing, twist, tip or separate causing death or serious injury.

⚠ WARNING - Child restraint anchorage

- Child restraint anchorages are designed to withstand only those loads imposed by correctly fitted child restraints. Under no circumstances are they to be used for adult seat belts or harnesses or for attaching other items or equipment to the vehicle.
- The tether strap may not work properly if attached somewhere other than the correct tether anchor.

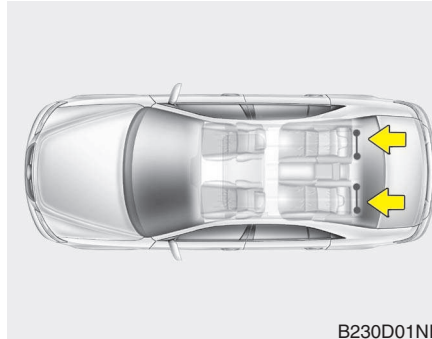

B230D01NF

C030104AFD-EA

Securing a child restraint system with “ISOFIX” system and “Anchorage Fitting Packages” system (if equipped)

ISOFIX is a standardised method of fitting child seats that eliminates the need to use the standard adult seat belt to secure the seat in the vehicle. This enables a much more secure and positive location with the added benefit of easier and quicker installation.

An ISOFIX-seat can only be installed if it has vehicle-specific approval in accordance with the requirements of relevant regulation.

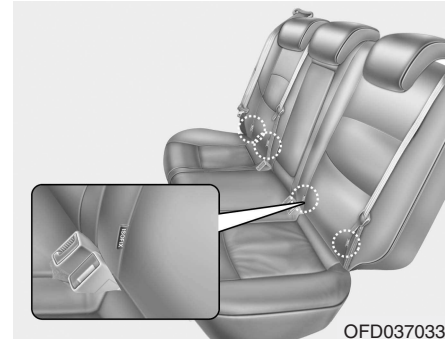

OFD037033

There are ISOFIX tags located on the lower portion of each side of the rear seatbacks. These tags indicate the position of the lower anchors for child restraints so equipped.

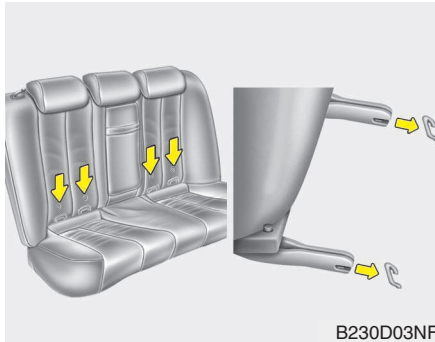

On each side of the rear seat, between the cushion and backrest, are located a pair of ISOFIX anchorage points together with a top tether mounting on the floor behind the rear seats. During the installation, the seat has to be engaged at the anchorage-points in a way you can hear it clicking (check by pulling!) and has to be fixed with the Top Tether-belt on the belonging point on the floor behind rear seats.

The installing and the use of a child-seat has to be done according to the installing-manual, which is added to the ISOFIX-seat.

⚠ WARNING

Install the child restraint seat fully rearward against the seatback with the seatback in a vertical position, not reclined.

⚠ WARNING

When using the vehicle's "ISOFIX" system to install a child restraint system in the rear seat, all unused vehicle rear seat belt metal latch plates or tabs must be latched securely in their seat belt buckles and the seat belt webbing must be retracted behind the child restraint to prevent the child from reaching and taking hold of unretracted seat belts. Unlatched metal latch plates or tabs may allow the child to reach the unretracted seat belts which may result in strangulation and a serious injury or death to the child in the child restraint.

To secure the child restraint seat

1. To engage the child restraint seat to the ISOFIX anchor, insert the child restraint seat latch into the ISOFIX anchor. Listen for the audible "click" sound.

⚠ CAUTION

Do not allow the rear seat belt webbing to get scratched or pinched by the ISOFIX-seat latch and ISOFIX anchor during the installation.

2. Connect the attaching clip to the child restraint hook holder and tighten to secure the seat. (Refer to the previous page.)

⚠ WARNING

- Do not install a child restraint seat at the centre of the rear seat using the vehicle's ISOFIX anchors. The ISOFIX anchors are only provided for the left and right outboard rear seating positions. Do not misuse the ISOFIX anchors by attempting to attach a child restraint seat in the middle of the rear seat to the ISOFIX anchors.

In a crash, the child restraint seat ISOFIX attachments may not be strong enough to secure the child restraint seat properly in the centre of the rear seat and may break, causing serious injury or death.

(Continued)

(Continued)

- Do not mount more than one child restraint to a child restraint lower anchorage point. The improper increased load may cause the anchorage points or tether anchor to break, causing serious injury or death.
- Attach the ISOFIX or ISOFIX-compatible child restraint seat only to the appropriate locations shown in the illustration.
- Always follow the installation and use instructions provided by the manufacturer of the child restraint.

AIR BAG - SUPPLEMENTAL RESTRAINT SYSTEM (IF EQUIPPED)

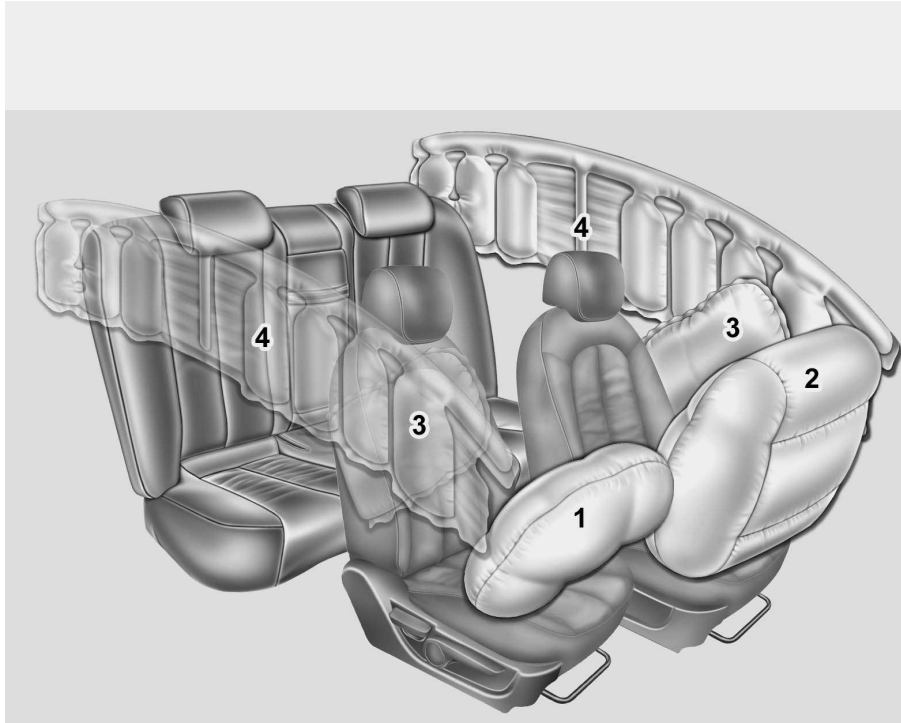

C040000AUN-EA

- (1) Driver's air bag
- (2) Passenger's air bag*
- (3) Side air bag*
- (4) Curtain air bag*

* : if equipped

⚠ WARNING

Even in vehicles with air bags, you and your passengers must always wear the safety belts provided in order to minimise the risk and severity of injury in the event of a collision or rollover.

* The actual air bags in the vehicle may differ from the illustration.

OHD036022R

C040100AFD-EA

SRS components and functions

The SRS consists of the following components:

1. Driver's front air bag module
2. Passenger's front air bag module*
3. Side air bag modules*
4. Curtain air bag modules*
5. Retractor pre-tensioner assemblies*
6. Air bag warning light
7. SRS control module (SRSCM)
8. Front impact sensors
9. Side impact sensors*
10. Passenger's front air bag OFF indicator (front passenger's seat only)*
11. Passenger's front air bag ON/OFF switch*

*: if equipped

The SRSCM continually monitors all elements while the ignition switch is ON to determine if a frontal or near-frontal impact is severe enough to require air bag deployment or pre-tensioner seat belt deployment.

The SRS air bag warning light on the instrument panel will illuminate for about 6 seconds after the ignition switch is turned to the ON position, after which the air bag warning light should go out.

If any of the following conditions occurs, this indicates a malfunction of the SRS. Have an authorised HYUNDAI dealer inspect the air bag system as soon as possible.

- The light does not turn on briefly when you turn the ignition ON.
- The light stays on after illuminating for approximately 6 seconds.
- The light comes on while the vehicle is in motion.

Driver's front air bag (1)

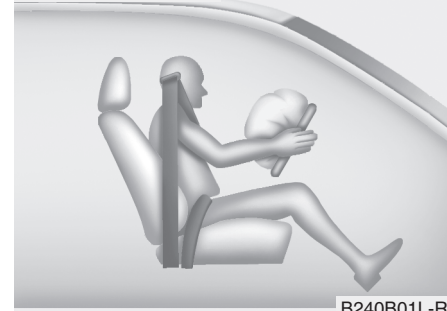

The air bag modules are located both in the centre of the steering wheel and in the front passenger's panel above the glove box. When the SRSCM detects a sufficiently severe impact to the front of the vehicle, it will automatically deploy the front air bags.

Safety system of your vehicle

Driver's front air bag (2)

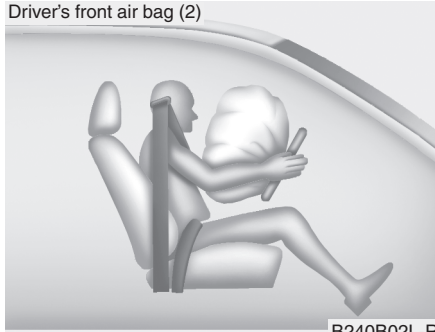

Upon deployment, tear seams molded directly into the pad covers will separate under pressure from the expansion of the air bags. Further opening of the covers then allows full inflation of the air bags.

Driver's front air bag (3)

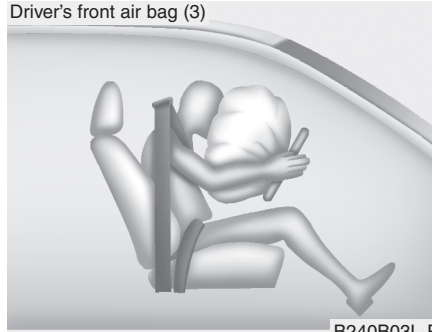

A fully inflated air bag, in combination with a properly worn seat belt, slows the driver's or the passenger's forward motion, reducing the risk of head and chest injury.

After complete inflation, the air bag immediately starts deflating, enabling the driver to maintain forward visibility and the ability to steer or operate other controls.

Passenger's front air bag



⚠ WARNING

- Do not install or place any accessories (drink holder, cassette holder, sticker, etc.) on the front passenger's panel above the glove box in a vehicle with a passenger's air bag. Such objects may become dangerous projectiles and cause injury if the passenger's air bag inflates.
- When installing a container of liquid air freshener inside the vehicle, do not place it near the instrument cluster nor on the instrument panel surface. It may become dangerous projectiles and cause injury if the passenger's air bag inflates.

⚠ WARNING

- If an air bag deploys, there may be a loud noise followed by a fine dust released in the vehicle. These conditions are normal and are not hazardous - the air bags are packed in this fine powder. The dust generated during air bag deployment may cause skin or eye irritation as well as aggravate asthma for some persons. Always wash all exposed skin areas thoroughly with lukewarm water and a mild soap after an accident in which the air bags were deployed.

(Continued)

(Continued)

- The SRS can function only when the ignition key is in the "ON" position. If the SRS air bag warning light does not illuminate, or continuously remains on after illuminating for about 6 seconds when the ignition key is turned to the ON position, or after the engine is started, comes on while driving, the SRS is not working properly. If this occurs, have your vehicle immediately inspected by an authorised HYUNDAI dealer.
- Before you replace a fuse or disconnect a battery terminal, turn the ignition switch to the LOCK position and remove the ignition key. Never remove or replace the air bag related fuse(s) when the ignition switch is in the ON position. Failure to heed this warning will cause the SRS air bag warning light to illuminate.



C040400AFD-EA

Driver's and passenger's front air bag (if equipped)

Your vehicle is equipped with a Supplemental Restraint (Air Bag) System and lap/shoulder belts at both the driver and passenger seating positions. The indications of the system's presence are the letters "SRS AIR BAG" embossed on the air bag pad cover in the steering wheel and the passenger's side front panel pad above the glove box.

The SRS consists of air bags installed under the pad covers in the centre of the steering wheel and the passenger's side front panel above the glove box.



The purpose of the SRS is to provide the vehicle's driver and/or the front passenger with additional protection than that offered by the seat belt system alone in case of a frontal impact of sufficient severity.

⚠ WARNING

Always use seat belts and child restraints – every trip, every time, everyone! Air bags inflate with considerable force and in the blink of an eye. Seat belts help keep occupants in proper position to obtain maximum benefit from the air bag. Even with air bags, improperly and unbelted occupants can be severely injured when the air bag inflates. Always follow the precautions about seat belts, air bags and occupant safety contained in this manual.

To reduce the chance of serious or fatal injuries and receive the maximum safety benefit from your restraint system:

- Never place a child in any child or booster seat in the front seat.
- ABC – Always Buckle Children in the back seat. It is the safest place for children of any age to ride.
- Front and side air bags can injure occupants improperly positioned in the front seats.

(Continued)

(Continued)

- Move your seat as far back as practical from the front air bags, while still maintaining control of the vehicle.
- You and your passengers should never sit or lean unnecessarily close to the air bags. Improperly positioned drivers and passengers can be severely injured by inflating air bags.
- Never lean against the door or centre console – always sit in an upright position.

(Continued)

(Continued)

- No objects should be placed over or near the air bag modules on the steering wheel, instrument panel, and the front passenger's panel above the glove box, because any such object could cause harm if the vehicle is in a crash severe enough to cause the air bags to deploy.
- Do not tamper with or disconnect SRS wiring or other components of the SRS system. Doing so could result in injury, due to accidental deployment of the air bags or by rendering the SRS inoperative.
- If the SRS air bag warning light remains illuminated while the vehicle is being driven, have an authorised HYUNDAI dealer inspect the air bag system as soon as possible.

(Continued)

(Continued)

- Air bags can only be used once – have an authorised HYUNDAI dealer replace the air bag immediately after deployment.
- The SRS is designed to deploy the airbags only when the impact is sufficiently severe and when the impact is in the front or frontal angle of the vehicle, and will not deploy in side, rear or rollover impacts. Additionally, the airbags will only deploy once. Thus, seat belts must be worn at all times.
- Front air bags are not intended to deploy in side-impact, rear-impact or rollover crashes. In addition, front air bags will not deploy in frontal crashes below the deployment threshold.

(Continued)

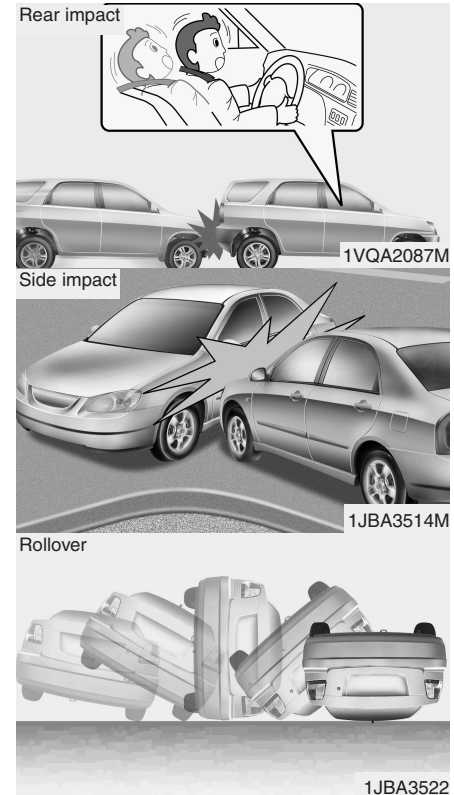

(Continued)

- A child restraint system must never be placed in the front seat. The infant or child could be severely injured or killed by an air bag deployment in case of an accident.
- Children age 12 and under must always be properly restrained in the rear seat. Never allow children to ride in the front passenger seat. If a child over 12 must be seated in the front seat, he or she must be properly belted and the seat should be moved as far back as possible.
- For maximum safety protection in all types of crashes, all occupants including the driver should always wear their seat belts whether or not an air bag is also provided at their seating position to minimise the risk of severe injury or death in the event of a crash. Do not sit or lean unnecessarily close to the air bag while the vehicle is in motion.

(Continued)

(Continued)

- Sitting improperly or out of position can result in serious or fatal injury in a crash. All occupants should sit upright with the seat back in an upright position, centred on the seat cushion with their seat belt on, legs comfortably extended and their feet on the floor until the vehicle is parked and the ignition key is removed.
- The SRS air bag system must deploy very rapidly to provide protection in a crash. If an occupant is out of position because of not wearing a seat belt, the air bag may forcefully contact the occupant causing serious or fatal injuries.

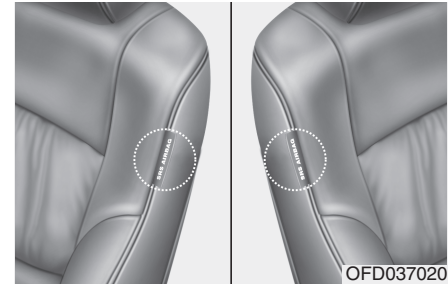

C040600AFD-EA

Side air bag (if equipped)

Your vehicle is equipped with a side air bag in each front seat. The purpose of the air bag is to provide the vehicle's driver and/or the front passenger with additional protection than that offered by the seat belt alone.

The side air bags are designed to deploy only during certain side-impact collisions, depending on the crash severity, angle, speed and point of impact. The side air bags are not designed to deploy in all side impact situations.

Important safety notes on the side air bag system

Following is a number of safety points concerning this system which should always be observed to ensure risk of injury is reduced in an accident.

 WARNING

- **The side air bag is supplemental to the driver's and the passenger's seat belt systems and is not a substitute for them. Therefore your seat belts must be worn at all times while the vehicle is in motion. The air bags deploy only in certain side impact conditions severe enough to cause significant injury to the vehicle occupants.**
- **For best protection from the side air bag system and to avoid being injured by the deploying side air bag, both front seat occupants should sit in an upright position with the seat belt properly fastened. The driver's hands should be placed on the steering wheel at the 9:00 and 3:00 positions. The passenger's arms and hands should be placed on their laps.**
- **Do not use any accessory seat covers.**
- **Use of seat covers could reduce or prevent the effectiveness of the system.**

(Continued)

(Continued)

- **Do not install any accessories on the side or near the side air bag.**
- **Do not place any objects over the air bag or between the air bag and yourself.**
- **Do not place any objects (an umbrella, bag, etc.) between the front door and the front seat. Such objects may become dangerous projectiles and cause injury if the supplemental side air bag inflates.**
- **To prevent unexpected deployment of the side air bag that may result in personal injury, avoid impact to the side impact sensor when the ignition key is on.**
- **If seat or seat cover is damaged, have the vehicle checked and repaired by an authorised HYUNDAI dealer. Inform that your vehicle is equipped with side air bags.**

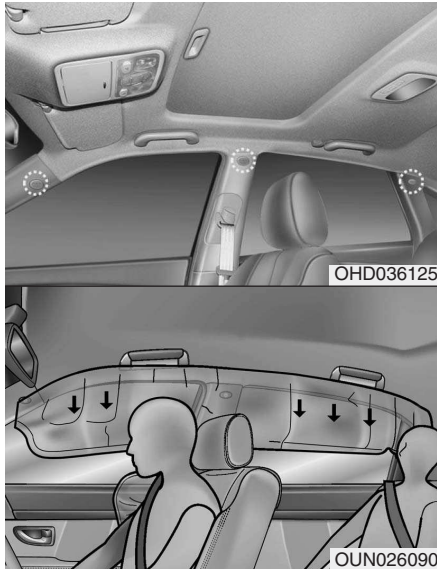

C040700AFD-EA

Curtain air bag (if equipped)

Curtain air bags are located along both sides of the roof rails above the front and rear doors.

They are designed to help protect the heads of the front seat occupants and the rear outboard seat occupants in certain side impact collisions.

The curtain air bags are designed to deploy only during certain side impact collisions, depending on the crash severity, angle, speed and impact. The curtain air bags are not designed to deploy in all side impact situations, collisions from the front or rear of the vehicle or in most rollover situations.

Important safety notes for curtain air bag systems

Following is a number of safety points concerning this system which should always be observed to ensure risk of injury is reduced in an accident.

⚠ WARNING

- Before installing child restraints, always refer to "Child Restraint System" to ensure correct installation and occupant protection is maximised.
- Make sure that the occupant does not have any body parts (head, arms & legs) protruding outside the restraining system. If an inflating airbag was to strike an infant child on the head, it may cause serious injury.

(Continued)

(Continued)

- Ensure the opening for the Curtain Airbag System remains unobstructed at all times, so that the airbags can inflate properly if needed.
- The built in coat hooks should only be used for light weight clothing, ensure that pockets are free of any heavy or sharp objects. When using coat hooks, do not hang clothes on coat hangers.
- The space between the occupant and the curtain airbag must never be occupied by children, passengers or pets. Occupants should never lean out or have any parts of their body protruding from the window whilst the engine is running.
- Do not move the sun visor out to cover the side window if there is an item attached to it such as garage door remote control, pens, air fresheners or the like. These objects may cause injury if the Curtain Airbag is deployed.

(Continued)

(Continued)

- Where sun blinds are fitted to the rear doors, these must not obstruct or impair the airbag in any way.
- Do not install any accessories or children's toys in the Curtain Airbag deployment zones, as this may impair the operation of the system or throw parts of them into the vehicle cabin causing injury to occupants if the system is deployed.
- To maintain the integrity of the Curtain Airbag system, any work, removal or installation of the airbag and associated components (such as roof lining and side trims) should always be performed by a qualified vehicle repairer.

 **WARNING**

- In order for side and curtain air bags to provide its best protection, both front seat occupants and both outboard rear occupants should sit in an upright position with the seat belts properly fastened. Importantly, children should sit in a proper child restraint system in the rear seat.
- When children are seated in the rear outboard seats, they must be seated in the proper child restraint system. Make sure to put the child restraint system as far away from the door side as possible, and secure the child restraint system in a locked position.

(Continued)

(Continued)

- Do not allow the passengers to lean their heads or bodies onto doors, put their arms on the doors, stretch their arms out of the window, or place objects between the doors and passengers when they are seated on seats equipped with side and/or curtain air bags.
- Never try to open or repair any components of the side curtain air bag system. This should only be done by an authorised HYUNDAI dealer.

Failure to follow the above mentioned instructions can result in injury or death to the vehicle occupants in an accident.

C040800AFD-EA

Why didn't my air bag go off in a collision? (Inflation and non-inflation conditions of the air bag)

There are many types of accidents in which the air bag would not be expected to provide additional protection.

These include rear impacts, second or third collisions in multiple impact accidents, as well as low speed impacts. In other words, just because your vehicle is damaged and even if it is totally unusable, don't be surprised that the air bags did not inflate.

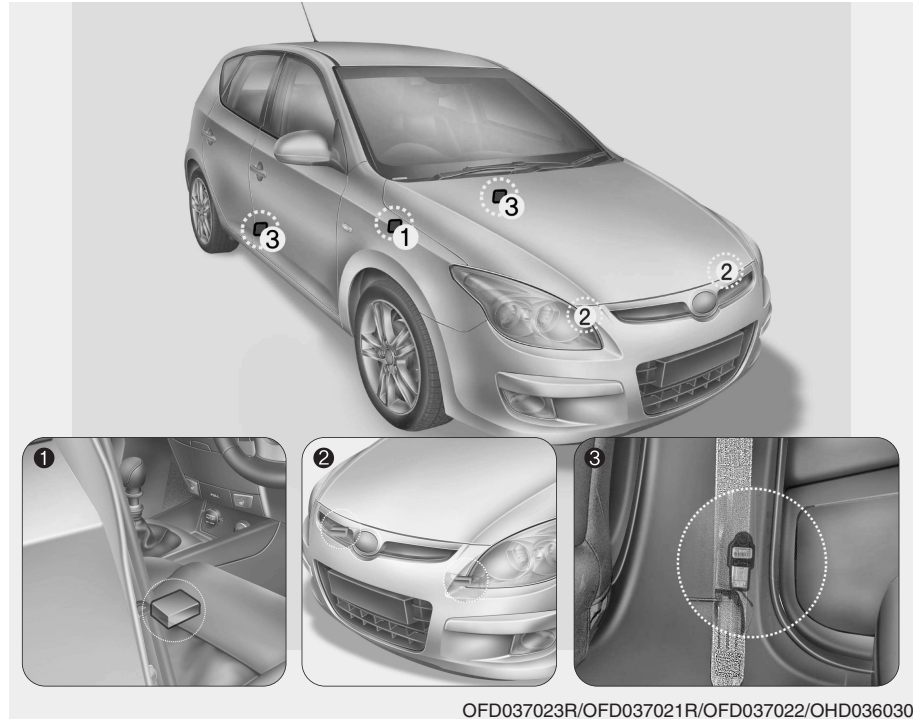

Air bag collision sensors

- (1) SRS control module
- (2) Front impact sensor

- (3) Side impact sensor (if equipped)

⚠ WARNING

- Do not hit or allow any objects to impact the locations where air bag or sensors are installed. This may cause unexpected air bag deployment, which could result in serious personal injury or death.
- If the installation location or angle of the sensors is altered in any way, the air bags may deploy when they should not or they may not deploy when they should, causing severe injury or death. Therefore, do not try to perform maintenance on or around the air bag sensors. Have the vehicle checked and repaired by an authorised HYUNDAI dealer.

(Continued)

(Continued)

- Problems may arise if the sensor installation angles are changed due to the deformation of the front bumper, body or B pillar where side collision sensors are installed. Have the vehicle checked and repaired by an authorised HYUNDAI dealer.
- Your vehicle has been designed to absorb impact and deploy the air bag(s) in certain collisions. Installing aftermarket bumper guards or replacing a bumper with non-genuine parts may adversely affect your vehicles collision and air bag deployment performance.



C040801AUN

Air bag inflation conditions

Front air bag

Front air bags are designed to inflate in a frontal collision depending on the intensity, speed or angles of impact of the front collision.



Side air bags (if equipped)

Side and/or curtain air bags are designed to inflate when an impact is detected by side collision sensors depending on the strength, speed or angles of impact resulting from a side impact collision or rollover.

Although the front air bags (driver's and front passenger's air bags) are designed to inflate only in frontal collisions, they also may inflate in other types of collisions if the front impact sensors detect a sufficient impact. Side air bags (side and/or curtain air bags) are designed to inflate only in side impact collisions, but they may inflate in other collisions if the side impact sensors detect a sufficient impact.

If the vehicle chassis is impacted by bumps or objects on unimproved roads or sidewalks, air bags may deploy. Drive carefully on unimproved roads or on surfaces not designed for vehicle traffic to prevent unintended air bag deployment.



C040802AUN

Air bag non-inflation conditions

- In certain low-speed collisions the air bags may not deploy. The air bags are designed not to deploy in such cases because they may not provide benefits beyond the protection of the seat belts in such collisions.

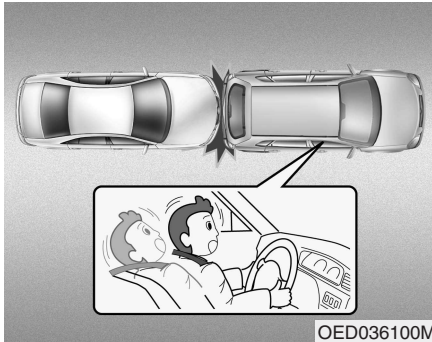

- Frontal air bags are not designed to inflate in rear collisions, because occupants are moved backward by the force of the impact. In this case, inflated air bags would not be able to provide any additional benefit.

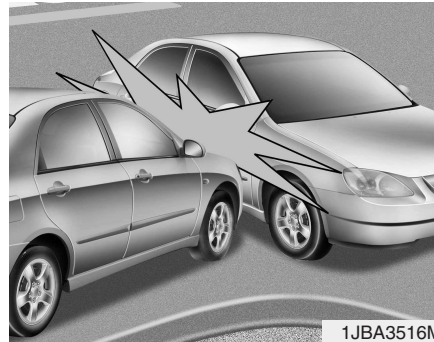

- Front air bags may not inflate in side impact collisions, because occupants move to the direction of the collision, and thus in side impacts, frontal air bag deployment would not provide additional occupant protection.
However, side or curtain air bags may inflate depending on the intensity, vehicle speed and angles of impact.

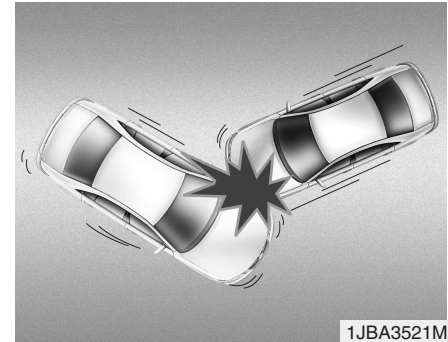

- In a slant or angled collision, the force of impact may direct the occupants in a direction where the air bags would not be able to provide any additional benefit, and thus the sensors may not deploy any air bags.

Safety system of your vehicle

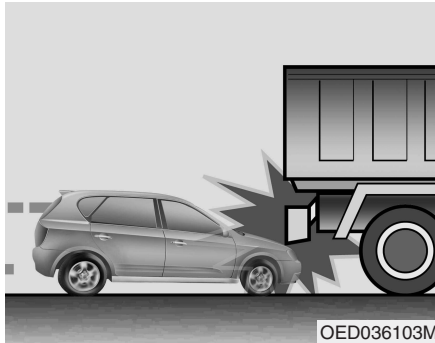

- Just before impact, drivers often brake heavily. Such heavy braking lowers the front portion of the vehicle causing it to “ride” under a vehicle with a higher ground clearance. Air bags may not inflate in this “under-ride” situation because deceleration forces that are detected by sensors may be significantly replaced by such “under-ride” collisions.

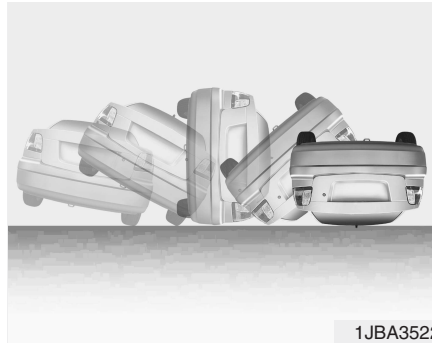

- Air bags may not inflate in rollover accidents because air bag deployment would not provide protection to the occupants. However, side and/or curtain air bags may inflate when the vehicle is rolled over by a side impact collision, if the vehicle is equipped with side air bags and curtain air bags.

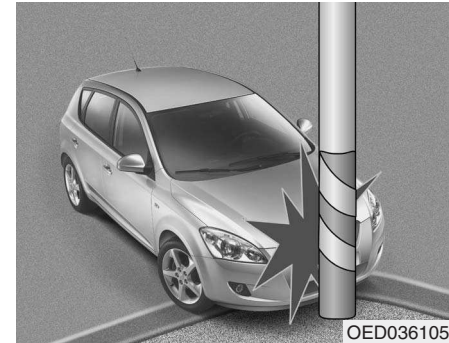

- Air bags may not inflate if the vehicle collides with objects such as utility poles or trees, where the point of impact is concentrated to one area and the full force of the impact is not delivered to the sensors.

C040900AUN

How does the air bag system operate

- Air bags are activated (able to inflate if necessary) only when the ignition switch is turned to the ON or START position.
- Air bags inflate instantly in the event of serious frontal or side collision (if equipped with side air bag or curtain air bag) in order to help protect the occupants from serious physical injury.
- There is no single speed at which the air bags will inflate.

Generally, air bags are designed to inflate by the severity of a collision and its direction. These two factors determine whether the sensors send out an electronic deployment/inflation signal.

- Air bag deployment depends on a number of factors including vehicle speed, angles of impact and the density and stiffness of the vehicles or objects which your vehicle hits in the collision. Though, factors are not limited to those mentioned above.
- The front air bags will completely inflate and deflate in an instant.

It is virtually impossible for you to see the air bags inflate during an accident. It is much more likely that you will simply see the deflated air bags hanging out of their storage compartments after the collision.

- In order to help provide protection in a severe collision, the air bags must inflate rapidly. The speed of air bag inflation is a consequence of the extremely short time in which a collision occurs and the need to get the air bag between the occupant and the vehicle structures before the occupant impacts those structures. This speed of inflation reduces the risk of serious or life-threatening injuries in a severe collision and is thus a necessary part of air bag design.

However, air bag inflation can also cause injuries which normally can include facial abrasions, bruises and broken bones, and sometimes more severe injuries because the inflation speed also causes the air bags to expand with a great deal of force.

- **There are even circumstances under which contact with the steering wheel air bag can cause fatal injuries, especially if the occupant is positioned excessively close to the steering wheel.**

WARNING

- **To avoid severe personal injury or death caused by deploying air bags in a collision, the driver should sit as far back from the steering wheel air bag as possible (at least 250 mm (10 inches) away). The front passenger should always move their seat as far back as possible and sit back in their seat.**
- **Air bag inflates instantly in an event of collision, passengers may be injured by the air bag expansion force if they are not in proper position.**
- **Air bag inflation may cause injuries which normally include facial or bodily abrasions, injuries from broken glasses or burns by the air bag inflation gasses.**

C040902AUN

Noise and smoke

When the air bags inflate, they make a loud noise and they leave smoke and powder in the air inside of the vehicle. This is normal and is a result of the ignition of the air bag inflator. After the air bag inflates, you may feel substantial discomfort in breathing due to the contact of your chest to both the seat belt and the air bag, as well as from breathing the smoke and powder. **We strongly urge you to open your doors and/or windows as soon as possible after impact in order to reduce discomfort and prevent prolonged exposure to the smoke and powder.**

Though smoke and powder are non-toxic, it may cause irritation to the skin (eyes, nose and throat etc). If this is the case, wash and rinse with the cold water immediately and consult the doctor if the symptom persists.

⚠ WARNING

When the air bags deploy, the air bag related parts in steering wheel and/or instrument panel and/or in both sides of the roof rails above the front and rear doors are very hot. To prevent injury, do not touch the air bag storage areas internal components immediately after an air bag has inflated.



C040903AUN

Installing a child restraint on a front passenger's seat is forbidden

Never place a rear-facing child restraint in the front passenger's seat. If the air bag deploys, it would impact the rear-facing child restraint, causing serious or fatal injury.

In addition, do not place front-facing child restraint in the front passenger's seat either. If the front passenger air bag inflates, it would cause serious or fatal injuries to the child.



(Continued)

- When children are seated in the rear outboard seats in which side air bags are equipped, be sure to put the child restraint system as far away from the door side as possible, and secure the child restraint system to be locked in position.

Inflation of side or curtain air bag could cause serious injury or death due to the expansion impact.



⚠ WARNING

- Extreme Hazard! Do not use a rearward facing child restraint on a seat protected by an air bag in front of it!
- Never put child restraint in the front passenger's seat. If the front passenger air bag inflates, it would cause serious or fatal injuries.

(Continued)

C041000AUN

Air bag warning light

The purpose of air bag warning light in your instrument panel is to alert you of a potential problem with your air bag - Supplemental Restraint System (SRS). When the ignition switch is turned ON, the indicator light should illuminate for approximately 6 seconds, then go off.

Have the system checked if:

- The light does not turn on briefly when you turn the ignition ON.
- The light stays on after illuminating for approximately 6 seconds.
- The light comes on while the vehicle is in motion.

C041100AFD-EA

SRS Care

The SRS is virtually maintenance-free and so there are no parts you can safely service by yourself. If the SRS air bag warning light does not illuminate, or continuously remains on, have your vehicle immediately inspected by an authorised HYUNDAI dealer.

Any work on the SRS system, such as removing, installing, repairing, or any work on the steering wheel must be performed by an authorised HYUNDAI dealer. Improper handling of the SRS system may result in serious personal injury.

WARNING

- **Modification to SRS components or wiring, including the addition of any kind of badges to the pad covers or modifications to the body structure, can adversely affect SRS performance and lead to possible injury.**
- **For cleaning the air bag pad covers, use only a soft, dry cloth or one which has been moistened with plain water. Solvents or cleaners could adversely affect the air bag covers and proper deployment of the system.**
- **No objects should be placed over or near the air bag modules on the steering wheel, instrument panel, and the front passenger's panel above the glove box, because any such object could cause harm if the vehicle is in a crash severe enough to cause the air bags to inflate.**

(Continued)

(Continued)

- **If the air bags inflate, they must be replaced by an authorised HYUNDAI dealer.**
- **Do not tamper with or disconnect SRS wiring, or other components of the SRS system. Doing so could result in injury, due to accidental inflation of the air bags or by rendering the SRS inoperative.**
- **If components of the air bag system must be discarded, or if the vehicle must be scrapped, certain safety precautions must be observed. An authorised HYUNDAI dealer knows these precautions and can give you the necessary information. Failure to follow these precautions and procedures could increase the risk of personal injury.**
- **If your car was flooded and has soaked carpeting or water on flooring, you shouldn't try to start the engine; have the car towed to an authorised HYUNDAI dealer.**

C041300AUN-EA

Additional safety precautions

- **Never let passengers ride in the cargo area or on top of a folded-down back seat.** All occupants should sit upright, fully back in their seats with their seat belts on and their feet on the floor.
- **Passengers should not move out of or change seats while the vehicle is moving.** A passenger who is not wearing a seat belt during a crash or emergency stop can be thrown against the inside of the vehicle, against other occupants, or out of the vehicle.
- **Each seat belt is designed to restrain one occupant.** If more than one person uses the same seat belt, they could be seriously injured or killed in a collision.
- **Do not use any accessories on seat belts.** Devices claiming to improve occupant comfort or reposition the seat belt can reduce the protection provided by the seat belt and increase the chance of serious injury in a crash.
- **Passengers should not place hard or sharp objects between themselves and the air bags.** Carrying hard or sharp objects on your lap or in your mouth can result in injuries if an air bag inflates.

- **Keep occupants away from the air bag covers.** All occupants should sit upright, fully back in their seats with their seat belts on and their feet on the floor. If occupants are too close to the air bag covers, they could be injured if the air bags inflate.
- **Do not attach or place objects on or near the air bag covers.** Any object attached to or placed on the front or side air bag covers could interfere with the proper operation of the air bags.
- **Do not modify the front seats.** Modification of the front seats could interfere with the operation of the supplemental restraint system sensing components or side air bags.
- **Do not place items under the front seats.** Placing items under the front seats could interfere with the operation of the supplemental restraint system sensing components and wiring harnesses.
- **Never hold an infant or child on your lap.** The infant or child could be seriously injured or killed in the event of a crash. All infants and children should be properly restrained in appropriate child safety seats or seat belts in the rear seat.

⚠ WARNING

- **Sitting improperly or out of position can cause occupants to be shifted too close to a deploying air bag, strike the interior structure or be thrown from the vehicle resulting in serious injury or death.**
- **Always sit upright with the seat-back in an upright position, centred on the seat cushion with your seat belt on, legs comfortably extended and your feet on the floor.**

C041400AUN

Adding equipment to or modifying your air bag-equipped vehicle

If you modify your vehicle by changing your vehicle's frame, bumper system, front end or side sheet metal or ride height, this may affect the operation of your vehicle's air bag system.

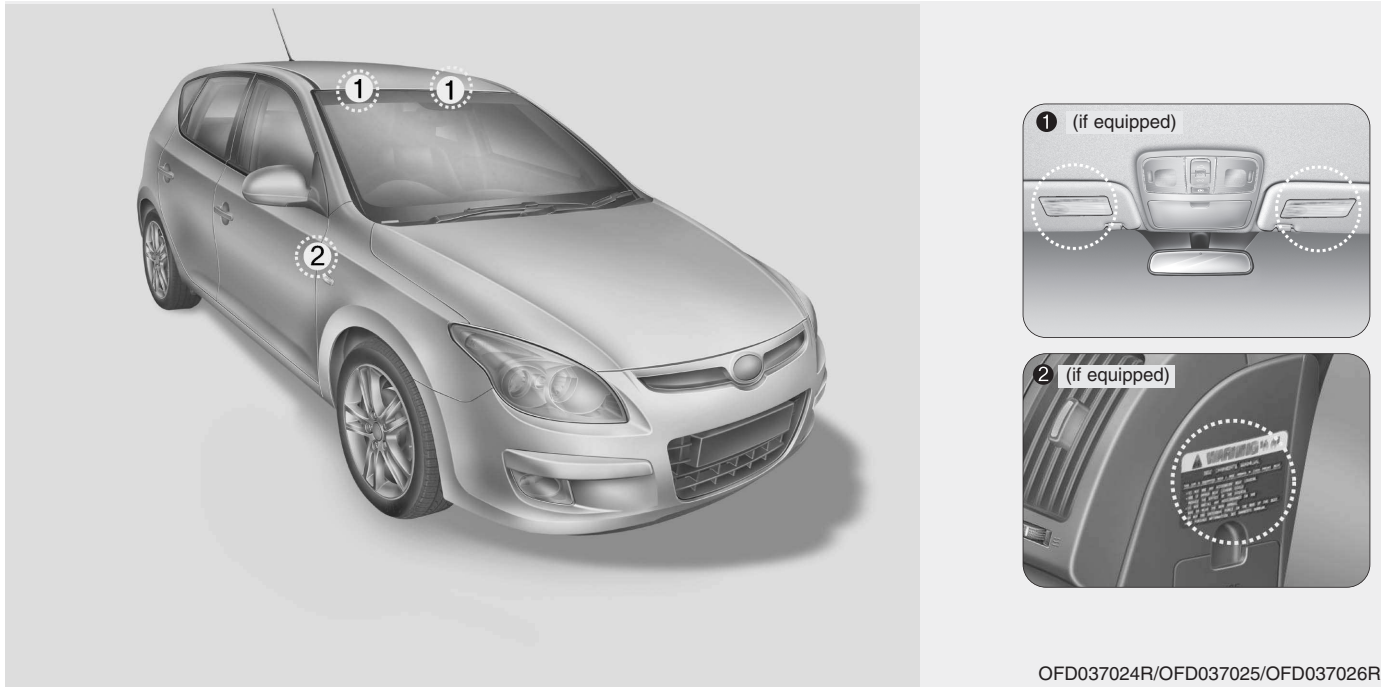

C041200AUN-EA

Air bag warning label

Air bag warning labels are attached to alert driver and passengers of potential risk of air bag system.

Note that these government warnings focus on the risk to children, and bring to your attention of the risks which adults are exposed to. These warnings have been described in previous pages.

Keys / 4-2
Remote keyless entry / 4-4
Theft-alarm system / 4-6
Door locks / 4-8
Tailgate / 4-12
Windows / 4-14
Bonnet / 4-19
Fuel filler lid / 4-21
Sunroof / 4-24

Features of your vehicle

4

Steering wheel / 4-28
Mirrors / 4-30
Instrument cluster / 4-34
Rear parking assist system / 4-48
Hazard warning flasher / 4-50
Lighting / 4-51
Wipers and washers / 4-56
Interior light / 4-60
Defroster / 4-62
Manual climate control system / 4-64
Automatic climate control system / 4-73
Windshield defrosting and defogging / 4-81
Storage compartment / 4-85
Interior features / 4-89
Exterior features / 4-99
Audio system / 4-101

KEYS



OFD047001UK

D010100AFD-EA

Record your key number

The key code number is stamped on the bar code tag attached to the key set. Should you lose your keys, this number will enable an authorised HYUNDAI dealer to duplicate the keys easily. Remove the bar code tag and store it in a safe place. Also, record the code number and keep it in a safe and handy place, but not in the vehicle.

D010200AFD

Key operations

Used to start the engine, lock and unlock the doors.

⚠ WARNING - Ignition key

Leaving children unattended in a vehicle with the ignition key is dangerous even if the key is not in the ignition. Children copy adults and they could place the key in the ignition. The ignition key would enable children to operate power windows or other controls, or even make the vehicle move, which could result in serious bodily injury or even death. **Never leave the keys in your vehicle with unsupervised children.**

⚠ WARNING

Use only HYUNDAI original parts for the ignition key in your vehicle. If an aftermarket key is used, the ignition switch may not return to ON after START. If this happens, the starter will continue to operate causing damage to the starter motor and possible fire due to excessive current in the wiring.



OFD047001-B

D010300AFD-EA

Immobiliser system

Your vehicle is equipped with an electronic engine immobiliser system to reduce the risk of unauthorised vehicle use.

Your immobiliser system is comprised of a small transponder in the ignition key, and antenna coil in the key cylinder and Immobiliser Control Unit (or Smartra Unit).

With this system, whenever you insert your ignition key into the ignition switch and turn it to ON, the antenna coil in the ignition switch receives a signal from the transponder in the ignition key and then sends the signal to the ECU (Engine Control Unit).

The ECU checks the signal whether the ignition key is valid. If the key is determined to be valid, the engine will start. If the key is determined to be invalid, the engine will not start.

To deactivate the immobiliser system:

Insert the ignition key into the key cylinder and turn it to the ON position.

To activate the immobiliser system:

Turn the ignition key to the OFF position. The immobiliser system activates automatically. Without a valid ignition key for your vehicle, the engine will not start.

 WARNING

In order to prevent theft of your vehicle, do not leave spare keys anywhere in your vehicle.

*** NOTICE**

When starting the engine, do not use the key with other immobiliser keys around. Otherwise the engine may not start or may stop soon after it starts. Keep each key separately not to have any malfunction after you receive your new vehicle.

 CAUTION

Do not put metal accessories near the ignition switch.

The engine may not start as the metal accessories may interrupt the transponder signal from normally transmitting.

*** NOTICE**

If you need additional keys or lose your keys, consult an authorised HYUNDAI dealer.

 CAUTION

The transponder in your ignition key is an important part of the immobiliser system. It is designed to give years of trouble-free service, however you should avoid exposure to moisture, static electricity and rough handling. Immobiliser system malfunction could occur.

 CAUTION

Do not change, alter or adjust the immobiliser system because it could cause the immobiliser system to malfunction and should only be serviced by an authorised HYUNDAI dealer.

Malfunctions caused by improper alterations, adjustments or modifications to the immobiliser system are not covered by your vehicle manufacturer warranty.

REMOTE KEYLESS ENTRY (IF EQUIPPED)

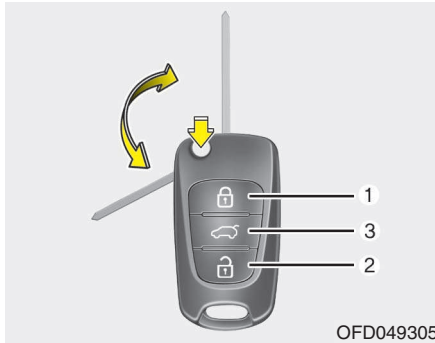

Remote keyless entry system operations

To unfold the key, press the release button then the key will unfold automatically. To fold the key, fold the key manually while pressing the release button.

CAUTION

Do not fold the key without pressing the release button. This may damage the key.

D020101AUN-EE

Lock (1)

All doors are locked if the lock button is pressed.

If all doors are closed, the hazard warning lights blink once to indicate that all doors are locked. However, if any door remains open, the hazard warning lights will not blink. If all doors are closed after the lock button is pressed, the hazard warning lights blink.

D020102AUN-EA

Unlock (2)

All doors are unlocked if the unlock button is pressed.

The hazard warning lights will blink twice to indicate that all doors are unlocked.

After depressing this button, the doors will relock automatically unless you open any door within 30 seconds.

D020104AUN-EA

Tailgate unlock (3)

The tailgate is unlocked if the button is pressed (for more than 0.5 seconds).

The hazard warning lights will blink twice to indicate that the tailgate is unlocked.

After depressing this button, the tailgate will relock automatically unless you open the tailgate within 30 seconds.

Also, once the tailgate is opened and then closed, the tailgate will lock automatically.

D020200AFD-EA

Transmitter precautions*** NOTICE**

The transmitter will not work if any of following occur:

- The ignition key is in ignition switch.
- You exceed the operating distance limit (about 10 m [30 feet]).
- The battery in the transmitter is weak.
- Other vehicles or objects may be blocking the signal.
- The weather is extremely cold.
- The transmitter is close to a radio transmitter such as a radio station or an airport which can interfere with normal operation of the transmitter.

When the transmitter does not work correctly, open and close the door with the ignition key. If you have a problem with the transmitter, contact an authorised HYUNDAI dealer.

⚠ CAUTION

Keep the transmitter away from water or any liquid. If the keyless entry system is inoperative due to exposure to water or liquids, it will not be covered by your manufacturer vehicle warranty.



OFD047003

D020300BFD-EA

Battery replacement

The transmitter uses a 3 volt lithium battery which will normally last for several years. When replacement is necessary, use the following procedure.

1. Insert a slim tool into the slot and gently pry open the transmitter centre cover (1).
2. Replace the battery with new one. When replacing the battery, make sure the battery positive “+” symbol faces up as indicated in the illustration.
3. Install the battery in the reverse order of removal.

For replacement transmitters, see an authorised HYUNDAI dealer for reprogramming.

⚠ CAUTION

- *The keyless entry system transmitter is designed to give you years of trouble-free use, however it can malfunction if exposed to moisture or static electricity. If you are unsure how to use your transmitter or replace the battery, contact an authorised HYUNDAI dealer.*
- *Using the wrong battery can cause the transmitter to malfunction. Be sure to use the correct battery.*
- *To avoid damaging the transmitter, don't drop it, get it wet, or expose it to heat or sunlight.*

⚠ CAUTION

An inappropriately disposed battery can be harmful to the environment and human health. Dispose the battery according to your local law(s) or regulation.

THEFT-ALARM SYSTEM (IF EQUIPPED)

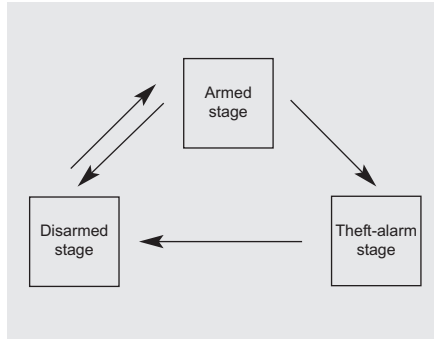

D030000AUN-EA

This system is designed to provide protection from unauthorised entry into the car. This system is operated in three stages: the first is the "Armed" stage, the second is the "Theft-alarm" stage, and the third is the "Disarmed" stage. If triggered, the system provides an audible alarm with blinking of the hazard warning lights.

D030100AUN-EA

Armed stage

Park the car and stop the engine. Arm the system as described below.

1. Remove the ignition key from the ignition switch and exit the vehicle.
2. Make sure that all doors (and tailgate) and the engine bonnet are closed and latched.
3. Lock the doors using the transmitter of the keyless entry system.

After completion of the steps above, the hazard warning lights will blink once to indicate that the system is armed.

If any door (or tailgate) or engine bonnet remains open, the hazard warning lights will not blink and the theft-alarm will not arm. If all doors (and tailgate) and engine bonnet are closed after the lock button is pressed, the hazard warning lights blink once.

- **Do not arm the system until all passengers have left the vehicle. If the system is armed while a passenger(s) remains in the vehicle, the alarm may be activated when the remaining passenger(s) leave the vehicle. If any door (or tailgate) or engine bonnet is opened within 30 seconds after the system enters the armed stage, the system is disarmed to prevent unnecessary alarm.**

D030200AFD-EA

Theft-alarm stage

The alarm will be activated if any of the following occurs while the system is armed.

- A front or rear door is opened without using the transmitter.
- The tailgate is opened without using the transmitter.
- The engine bonnet is opened.

The siren will sound and the hazard warning lights will blink continuously for 27 seconds, unless the system is disarmed. To turn off the system, unlock the doors with the ignition key (*) or transmitter.

(*) : To enable the ignition key to function, consult your authorised HYUNDAI dealer.

D030400AFD-EA

Disarmed stage

The system will be disarmed when the doors are unlocked by depressing the unlock button on the transmitter.

After depressing unlock button, the hazard warning lights will blink twice to indicate that the system is disarmed.

After depressing unlock button, if any door is not opened within 30 seconds, the system will be rearmed.

*** NOTICE**

- **If the system is not disarmed with the transmitter, insert the key into the ignition switch and start the engine. Then the system will be disarmed.**
- **If you lose your keys, consult your authorised HYUNDAI dealer.**

**CAUTION**

Do not change, alter or adjust the theft-alarm system because it could cause the theft-alarm system to malfunction and should only be serviced by an authorized HYUNDAI dealer.

Malfunctions caused by improper alterations, adjustments or modifications to the theft-alarm system are not covered by your vehicle manufacturer warranty.

DOOR LOCKS

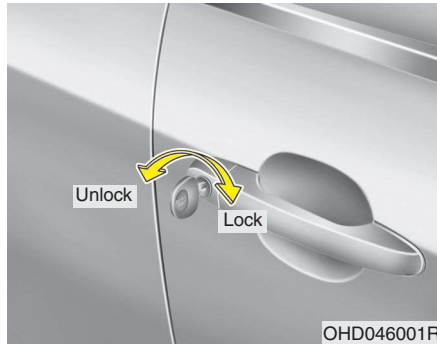

D050100AUN-EA

Operating door locks from outside the vehicle

- Turn the key towards the rear of vehicle to unlock and towards the front of vehicle to lock.
- If you lock/unlock the door with a key, all vehicle doors will lock/unlock automatically.

- Doors can also be locked and unlocked with the transmitter key (if equipped).
- Once the doors are unlocked, they may be opened by pulling the door handle.
- When closing the door, push the door by hand. Make sure that doors are closed securely.

※ If your vehicle is equipped with the remote keyless entry system, there is no key lock on the front passenger's door.

* NOTICE

- In cold and wet climates, door lock and door mechanisms may not work properly due to freezing conditions.
- If the door is locked/unlocked multiple times in rapid succession with either the vehicle key or door lock switch, the system may stop operating temporarily in order to protect the circuit and prevent damage to system components.

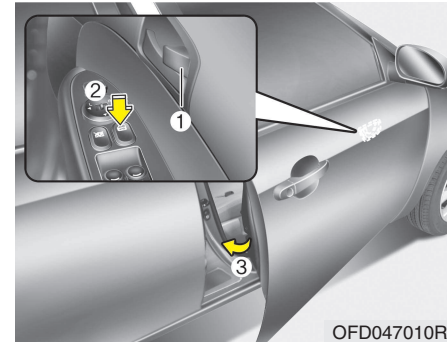

- To lock a door without the key, push the inside door lock button (1) or central door lock switch (2) to the "Lock" position and close the door (3).
- If you lock the door with the central door lock switch, all vehicle doors will lock automatically.

* NOTICE

Always remove the ignition key, engage the hand brake, close all windows and lock all doors when leaving your vehicle unattended.

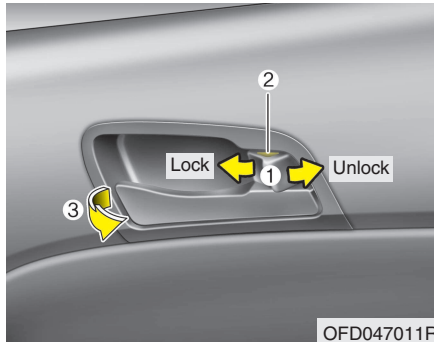

Operating door locks from inside the vehicle

D050201AFD

With the door lock button

- To unlock a door, push the door lock button (1) to the “Unlock” position. The red mark (2) on the button will be visible.
- To lock a door, push the door lock button (1) to the “Lock” position. If the door is locked properly, the red mark (2) on the door lock button will not be visible.
- To open a door, pull the door handle (3) outward.
- If the inner door handle of the front door is pulled when the door lock button is in lock position, the button is unlocked and door opens. (if equipped)

- Front doors cannot be locked if the ignition key is in the ignition switch and any front door is open.

⚠ WARNING - Door lock malfunction

If a power door lock ever fails to function while you are in the vehicle, try one or more of the following techniques to exit:

- Operate the door unlock feature repeatedly (both electronic and manual) while simultaneously pulling on the door handle.
- Operate the other door locks and handles, front and rear.
- Lower a front window and use the key to unlock the door from outside.
- Move to the cargo area and open the tailgate.



D050202AUN-EA

With central door lock switch

Operate by depressing the central door lock switch.

- When pushing down on the front portion (1) of the switch, all vehicle doors will lock.
- When pushing down on the rear portion (2) of the switch, all vehicle doors will unlock.
- However, if the key is in the ignition switch and any front door is open, the doors will not lock when the front portion of central door lock switch is pressed.

WARNING - Doors

- The doors should always be fully closed and locked while the vehicle is in motion to prevent accidental opening of the door. Locked doors will also discourage potential intruders when the vehicle stops or slows.
- Be careful when opening doors and watch for vehicles, motorcycles, bicycles or pedestrians approaching the vehicle in the path of the door. Opening a door when something is approaching can cause damage or injury.

WARNING - Unlocked vehicles

Leaving your vehicle unlocked can invite theft or possible harm to you or others from someone hiding in your vehicle while you are gone. Always remove the ignition key, engage the hand brake, close all windows and lock all doors when leaving your vehicle unattended.

WARNING - Unattended children

An enclosed vehicle can become extremely hot, causing death or severe injury to unattended children or animals who cannot escape the vehicle. Furthermore, children might operate features of the vehicle that could injure them, or they could encounter other harm, possibly from someone gaining entry to the vehicle. Never leave children or animals unattended in your vehicle.

D050600ANF

Deadlocks (if equipped)

Some vehicles are equipped with a deadlocking system. Deadlocks prevent opening of a door from either inside or outside the vehicle once the deadlocks have been activated providing an additional measure of vehicle security.

To lock the vehicle using the deadlock function, the doors must be locked using the key or the Remote Keyless Entry transmitter. To unlock the vehicle, the key or the transmitter must again be used.

To lock a vehicle without using the deadlock function, the doors should be locked by depressing the central door lock switch and closing the doors.

WARNING

Occupants must not be allowed to remain in the vehicle when the deadlocking system is activated since it will not be possible for them, or persons outside the vehicle, to open the doors and leave the vehicle in case of an emergency.

D050300AUN-EA

Impact sensing door unlock system (if equipped)

All doors will automatically unlock when an impact is acknowledged by the impact sensors while the ignition is switch ON. However, the doors may not be unlocked if mechanical problems occur with the door lock system or battery.

D050400AFD-EA

Speed sensing door lock system (if equipped)

Type A

When the speed of the vehicle reaches above 40 km/h for 1 second, it will automatically lock all doors. For activation of this feature, contact an authorised HYUNDAI dealer.

Type B

When the speed of the vehicle reaches above 15 km/h for 1 second, it will automatically lock all doors. For activation of this feature, contact an authorised HYUNDAI dealer.

* NOTICE

An authorised HYUNDAI dealer can select some auto door lock/unlock features as follows;

- Speed sensing auto door locking
- Auto door unlock when the ignition key is removed from the ignition switch

If you want to select a door lock/unlock feature, consult an authorised HYUNDAI dealer.

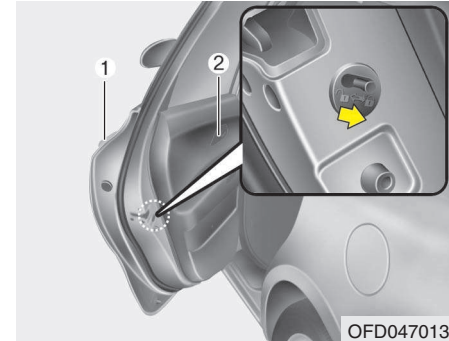

D050500AUN

Child-protector rear door lock

The child safety lock is provided to help prevent children from accidentally opening the rear doors from inside the vehicle. The rear door safety locks should be used whenever children are in the vehicle.

1. Open the rear door.
2. Push the child safety lock located on the rear edge of the door to the “Lock” position. When the child safety lock is in the “Lock (🔒)” position, rear door will not open even when the inner door handle is pulled inside the vehicle.
3. Close the rear door.

To open the rear door, pull the outside door handle (1).

Even though the doors may be unlocked, the rear door will not open by pulling the inner door handle (2) until rear door child safety lock is unlocked ().

WARNING - Rear door locks

If children accidentally open the rear doors while the vehicle is in motion, they could fall out of the vehicle, resulting in severe injury or death. To prevent children from opening the rear doors from the inside, the rear door safety locks should be used whenever children are in the vehicle.

TAILGATE

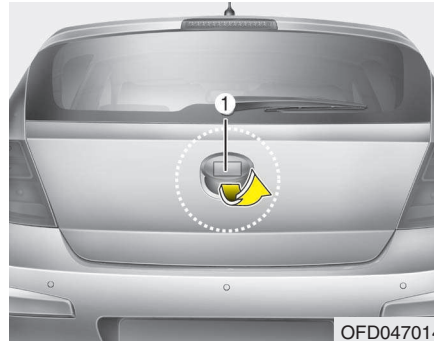

D070100AFD

Opening the tailgate

- The tailgate is locked or unlocked together if all doors are locked or unlocked with the key, transmitter or central door lock switch.
- The tailgate is unlocked alone for 30 seconds if the tailgate unlock button on the transmitter is pressed. Once the tailgate is opened and then closed, the tailgate is locked automatically.
- If unlocked, the tailgate can be opened by pressing the handle and pulling it up.

* NOTICE

In cold and wet climates, door lock and door mechanisms may not work properly due to freezing conditions.

WARNING

The tailgate swings upward. Make sure no objects or people are near the rear of the vehicle when opening the tailgate.

CAUTION

Make certain that you close the tailgate before driving your vehicle. Possible damage may occur to the tailgate lift cylinders and attaching hardware if the tailgate is not closed prior to driving.

D070200AUN

Closing the tailgate

To close the tailgate, lower and push down the tailgate firmly. Make sure that the tailgate is securely latched.

⚠ WARNING - Exhaust fumes

If you drive with the tailgate open, you will draw dangerous exhaust fumes into your vehicle which can cause serious injury or death to vehicle occupants.

If you must drive with the tailgate open, keep the air vents and all windows open so that additional outside air comes into the vehicle.

⚠ WARNING - Rear cargo area

Occupants should never ride in the rear cargo area where no restraints are available. To avoid injury in the event of an accident or sudden stops, occupants should always be properly restrained.

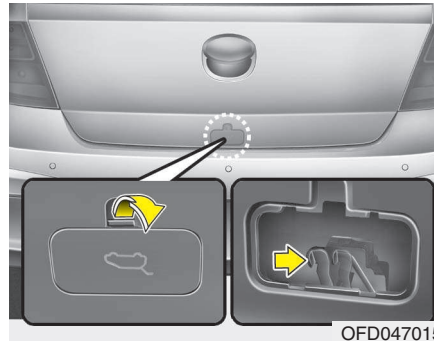

OFD047015

D070300AUN

Emergency tailgate safety release

Your vehicle is equipped with emergency tailgate safety release lever located on the bottom of the tailgate. When someone is inadvertently locked in the luggage compartment, if the lever is pushed, the tailgate latch mechanism is released and the tailgate is opened by pushing backward.

⚠ WARNING

- For emergency, be fully aware of the location of the emergency tailgate safety release lever in their vehicle and how to open the tailgate if you are accidentally locked in the luggage compartment.
- No one should be allowed to occupy the luggage compartment of the vehicle at any time. The luggage compartment is a highly dangerous location in the event of a crash.
- Use the release lever for emergency only. Use extreme caution while the vehicle is in motion.

WINDOWS

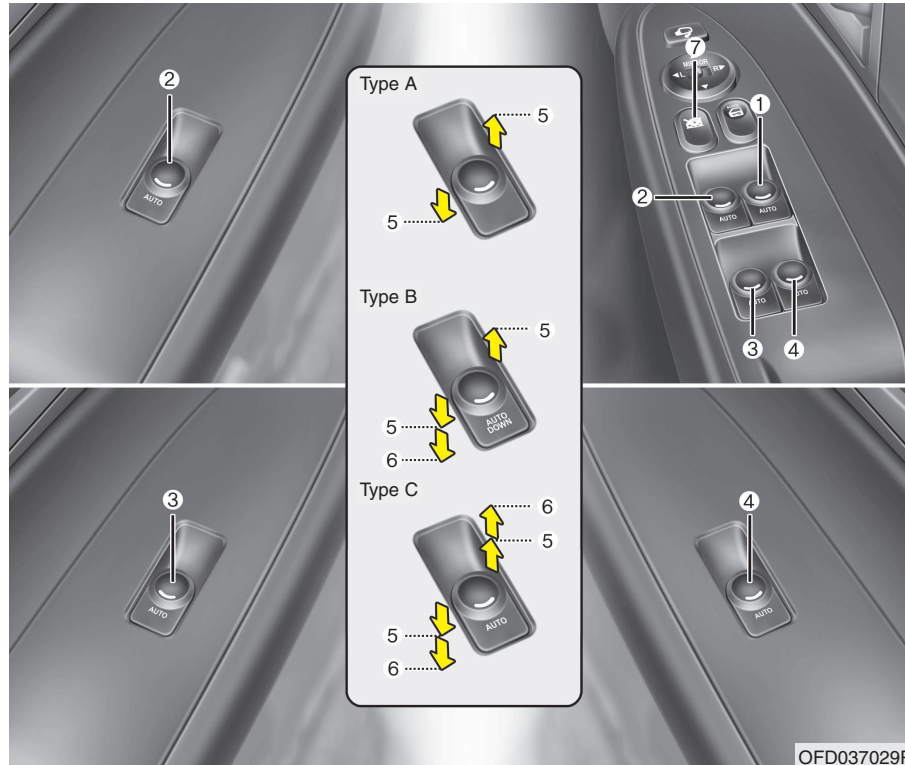

D080000AFD

- (1) Driver's door power window switch
- (2) Front passenger's door power window switch
- (3) Rear door (left) power window switch
- (4) Rear door (right) power window switch
- (5) Window opening and closing
- (6) Automatic power window up*/down*
- (7) Power window lock switch

*: if equipped

* NOTICE

In cold and wet climates, power windows may not work properly due to freezing conditions.

D080100BFD

Power windows

The ignition switch must be in the ON position for power windows to operate. Each door has a power window switch that controls the door's window. The driver has a power window lock switch which can block the operation of rear passenger windows.

The power windows can be operated for approximately 30 seconds after the ignition key is removed or turned to the ACC or LOCK position. However, if the front doors are opened, the power windows cannot be operated even within the 30 seconds period after the ignition key removal.

* NOTICE

While driving with the rear windows down or with the sunroof (if equipped) in an open (or partially open) position, your vehicle may demonstrate a wind buffeting or pulsation noise. This noise is a normal occurrence and can be reduced or eliminated by taking the following actions. If the noise occurs with one or both of the rear windows down, partially lower both front windows approximately one inch. If you experience the noise with the sunroof open, slightly reduce the size of the sunroof opening.

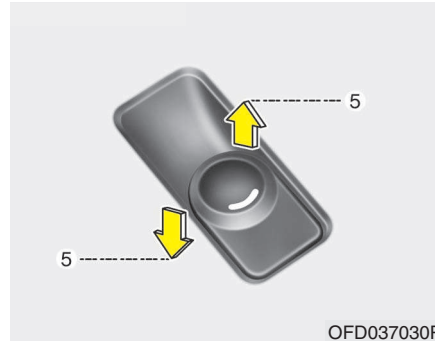

OFD037030R

D080101AUN

Window opening and closing (if equipped)

The driver's door has a master power window switch that controls all the windows in the vehicle.

To open or close a window, press down or pull up the front portion of the corresponding switch to the first detent position (5).



OFD037031R

D080102AUN

Auto down window (if equipped)

Depressing the power window switch momentarily to the second detent position (6) completely lowers the driver's window even when the switch is released. To stop the window at the desired position while the window is in operation, momentarily pull the switch in the direction opposite of the window's movement.

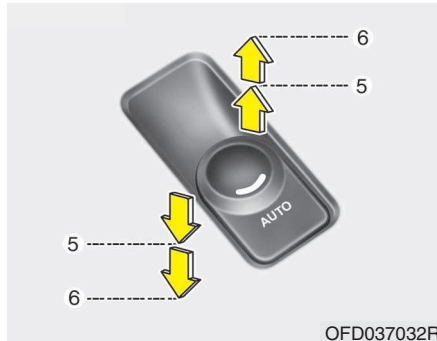

D080103AUN

Auto up/down window (if equipped)

Depressing or pulling up the power window switch momentarily to the second detent position (6) completely lowers or lifts the window even when the switch is released. To stop the window at the desired position while the window is in operation, pull up or depress and release the switch to the opposite direction of the movement.

If the power window is not operated correctly, the automatic power window system must be reset as follows:

1. Turn the ignition switch to the ON position.
2. Close driver's window and continue pulling up on driver's power window switch for at least 1 second after the window is completely closed.

Automatic reversal

If the upward movement of the window is blocked by an object or part of the body, the window will detect the resistance and will stop upward movement. The window will then lower approximately 30 cm (11.8 in.) to allow the object to be cleared.

If the window detects the resistance while the power window switch is pulled up continuously, the window will stop upward movement then lower approximately 2.5 cm (1 in.). And if the power window switch is pulled up continuously again within 5 seconds after the window is lowered by the automatic window reversal feature, the automatic window reversal will not operate.

*** NOTICE**

The automatic reverse feature for the driver's window is only active when the "auto up" feature is used by fully pulling up the switch. The automatic reverse feature will not operate if the window is raised using the halfway position on the power window switch.

⚠ WARNING

Always check for obstructions before raising any window to avoid injuries or vehicle damage. If an object less than 4 mm (0.16 in.) in diameter is caught between the window glass and the upper window channel, the automatic reverse window may not detect the resistance and will not stop and reverse direction.



D080104AUN

Power window lock button

- The driver can disable the power window switches on a rear passenger door by depressing the power window lock switch located on the driver's door to LOCK (pressed).
- **When the power window lock switch is ON, the driver's master control cannot operate the rear passenger door power windows.**

⚠ CAUTION

- *To prevent possible damage to the power window system, do not open or close two windows or more at the same time. This will also ensure the longevity of the fuse.*
- *Never try to operate the main switch on the driver's door and the individual door window switch in opposing directions at the same time. If this is done, the window will stop and cannot be opened or closed.*

⚠ WARNING - Windows

- **NEVER** leave the ignition key in the vehicle.
- **NEVER** leave any child unattended in the vehicle. Even very young children may inadvertently cause the vehicle to move, entangle themselves in the windows, or otherwise injure themselves or others.
- Always double check to make sure all arms, hands, head and other obstructions are safely out of the way before closing a window.
- Do not allow children to play with the power windows. Keep the driver's door power window lock switch in the LOCK position (depressed). Serious injury can result from unintentional window operation by the child.
- Do not extend any head or arms outside through the window opening while driving.

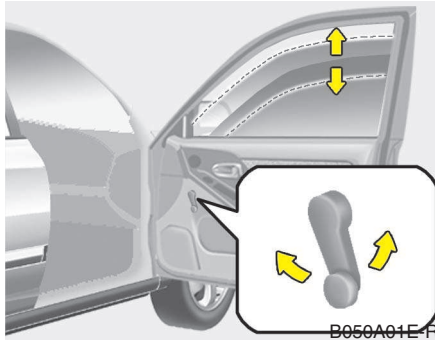

D080200AFD

Manual windows (if equipped)

To raise or lower the window, turn the window regulator handle clockwise or counterclockwise.

⚠ WARNING

When opening or closing the windows, make sure your passenger's arms, hands and body are safely out of the way.

BONNET

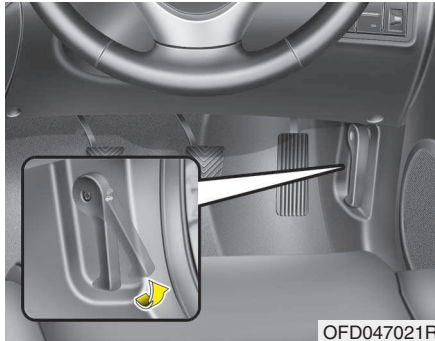

OFD047021R

D090100AUN-EA

Opening the bonnet

1. Pull the release lever to unlatch the bonnet. The bonnet should pop open slightly.

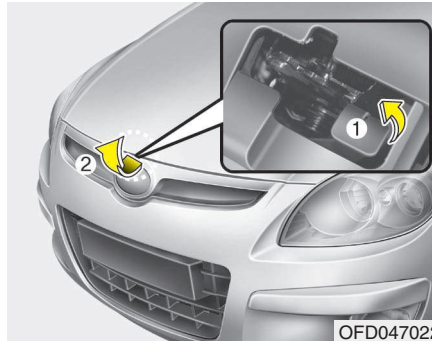

OFD047022

2. Go to the front of the vehicle, raise the bonnet slightly, pull the secondary latch (1) inside of the bonnet centre and lift the bonnet (2).

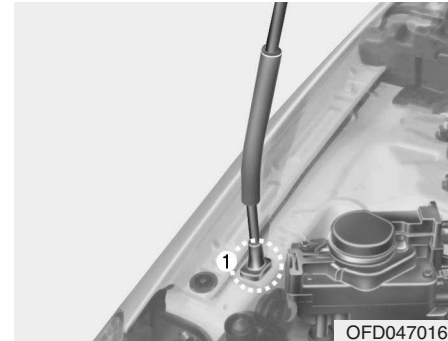

OFD047016

3. Pull the support rod from the bonnet.
4. Hold the bonnet open with the support rod.

⚠ WARNING - Hot parts

Grasp the support rod in the area wrapped in rubber. The rubber will help prevent you from being burned by hot metal when the engine is hot.

D090200AUN-EA

Closing the bonnet

1. Before closing the bonnet, check the following:
 - All filler caps in engine compartment must be correctly installed.
 - Gloves, rags or any other combustible material must be removed from the engine compartment.
2. Return the support rod to its clip to prevent it from rattling.
3. Lower the bonnet until it is about 30 cm (1 ft.) above the closed position and let it drop. Make sure that it locks into place.

WARNING - Bonnet

- Before closing the bonnet, ensure that all obstructions are removed from the bonnet opening. Closing the bonnet with an obstruction present in the bonnet opening may result in property damage or severe personal injury.
- Do not leave gloves, rags or any other combustible material in the engine compartment. Doing so may cause a heat-induced fire.

WARNING

- Always double check to be sure that the bonnet is firmly latched before driving away. If it is not latched, the bonnet could fly open while the vehicle is being driven, causing a total loss of visibility, which might result in an accident.
- The support rod must be inserted completely into the hole provided in the bonnet whenever you inspect the engine compartment. This will prevent the bonnet from falling and possibly injuring you.
- Do not move the vehicle with the bonnet in the raised position, as vision is obstructed and the bonnet could fall or be damaged.

FUEL FILLER LID

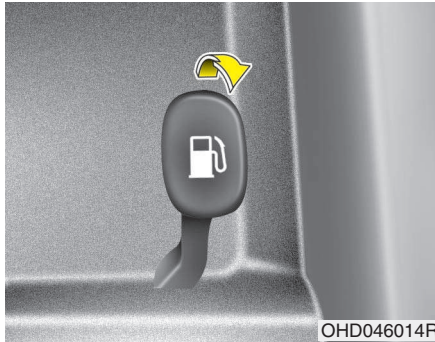

OHD046014R

D100100AFD

Opening the fuel filler lid

The fuel-filler lid must be opened from inside the vehicle by pulling up on the fuel-filler lid opener located on the front floor area on the driver's seat.

* NOTICE

If the fuel-filler lid will not open because ice has formed around it, tap lightly or push on the lid to break the ice and release the lid. Do not pry on the lid. If necessary, spray around the lid with an approved de-icer fluid (do not use radiator anti-freeze) or move the vehicle to a warm place and allow the ice to melt.

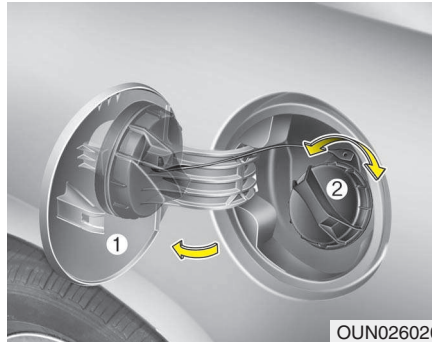

OUN026020

D100200AUN

Closing the fuel filler lid

1. To install the cap, turn it clockwise until it "clicks". This indicates that the cap is securely tightened.
2. Close the fuel filler lid and push it in lightly making sure that it is securely closed.

1. Stop the engine.
2. To open the fuel filler lid, pull the fuel filler lid opener up.
3. Pull the fuel filler lid (1) out to fully open.
4. To remove the cap (2), turn the fuel tank cap counterclockwise.
5. Refuel as needed.

D100300AFD-EA

WARNING - Refuelling

- If pressurized fuel sprays out, it can cover your clothes or skin and thus subject you to the risk of fire and burns. Always remove the fuel cap carefully and slowly. If the cap is venting fuel or if you hear a hissing sound, wait until the condition stops before completely removing the cap.
- Do not "top off" after the nozzle automatically shuts off when refuelling.
- Always check that the fuel cap is installed securely to prevent fuel spillage in the event of an accident.

WARNING - Refuelling dangers

Automotive fuels are flammable materials. When refuelling, please note the following guidelines carefully. Failure to follow these guidelines may result in severe personal injury, severe burns or death by fire or explosion.

- Read and follow all warnings posted at the petrol station facility.
- Before refuelling, note the location of the Emergency Fuel Shut-Off, if available, at the petrol station facility.
- Before touching the fuel nozzle, you should eliminate potentially dangerous static electricity discharge by touching another metal part of the vehicle, a safe distance away from the fuel filler neck, nozzle, or other petrol source.

(Continued)

(Continued)

- Do not get back into a vehicle once you have begun refuelling since you can generate static electricity by touching, rubbing or sliding against any item or fabric (polyester, satin, nylon, etc.) capable of producing static electricity. Static electricity discharge can ignite fuel vapours resulting in rapid burning. If you must re-enter the vehicle, you should once again eliminate potentially dangerous static electricity discharge by touching a metal part of the vehicle, away from the fuel filler neck, nozzle or other petrol source.
- When using a portable fuel container be sure to place the container on the ground prior to refuelling. Static electricity discharge from the container can ignite fuel vapours causing a fire. Once refuelling has begun, contact with the vehicle should be maintained until the filling is complete.

(Continued)

(Continued)

- Use only portable plastic fuel containers designed to carry and store petrol.
- Do not use mobile phones while refuelling. Electric current and/or electronic interference from mobile phones can potentially ignite fuel vapours causing a fire.
- When refuelling, always shut the engine off. Sparks produced by electrical components related to the engine can ignite fuel vapours causing a fire. Once refuelling is complete, check to make sure the filler cap and filler door are securely closed, before starting the engine.
- DO NOT use matches or a lighter and DO NOT SMOKE or leave a lit cigarette in your vehicle while at a petrol station especially during refuelling. Automotive fuel is highly flammable and can, when ignited, result in fire.

(Continued)

(Continued)

- If a fire breaks out during refuelling, leave the vicinity of the vehicle, and immediately contact the manager of the petrol station and then contact the local fire department. Follow any safety instructions they provide.

 **CAUTION**

- *Make sure to refuel your vehicle according to the "Fuel requirements" suggested in section 1.*
- *If the fuel filler cap requires replacement, use only a genuine HYUNDAI cap or the equivalent specified for your vehicle. An incorrect fuel filler cap can result in a serious malfunction of the fuel system or emission control system.*

(Continued)

(Continued)

- *Do not spill fuel on the exterior surfaces of the vehicle. Any type of fuel spilled on painted surfaces may damage the paint.*
- *After refuelling, make sure the fuel cap is installed securely to prevent fuel spillage in the event of an accident.*

SUNROOF (IF EQUIPPED)



OFD047023

D110000AUN

If your vehicle is equipped with this feature, you can slide or tilt your sunroof with the sunroof control buttons located on the overhead console.

1. Slide button
2. Tilt button
3. Close button

The sunroof can only be opened, closed, or tilted when the ignition switch is in the ON position.

* NOTICE

- In cold and wet climates, sunroof may not work properly due to freezing conditions.
- After washing the car or after there is rain, be sure to wipe off any water that is on the sunroof before operating it.

! CAUTION

Do not continue to press the sunroof control button(s) after the sunroof is in the fully open, closed, or tilt position(s). Damage to the motor or system components could occur.

* NOTICE

The sunroof cannot slide when it is in the tilt position nor can it be tilted while in an open or slide position.

! WARNING

Never adjust the sunshade while driving. This could result in loss of control and an accident that may cause death, serious injury, or property damage.



OFD047024

D110100AFD

Sliding the sunroof

To open the sunroof (autoslide feature), press the slide button (1) on the overhead console for more than 0.5 second.

The sunroof will slide to the recommended open position (about 50mm before the maximum slide open position).

To stop the sunroof sliding at any point, press any sunroof control button.

To open the sunroof to the maximum slide open position, press the slide button (1) once again and hold it until the sunroof slide all the way open.

*** NOTICE**

To reduce wind noise while driving, we recommend you to drive at the recommended position (about 50mm before the maximum slide open position).

To close the sunroof (autoslide feature), press the close button (3) on the overhead console for more than 0.5 second. The sunroof will slide all the way close. To stop the sunroof sliding at any point, press any sunroof control button.

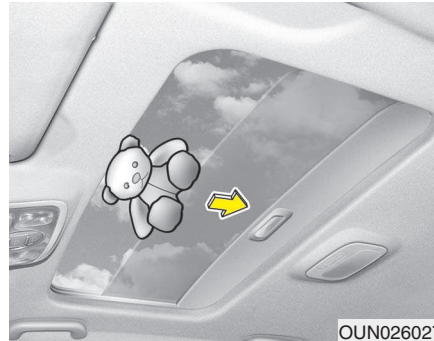

D110101AUN

OUN026027

Automatic reversal

If an object or part of the body is detected while the sunroof is closing automatically, it will reverse direction, and then stop.

Auto reverse function does not work if a tiny obstacle is between the sliding glass and the sunroof sash. You should always check that all passengers and objects are away from the sunroof before closing it.

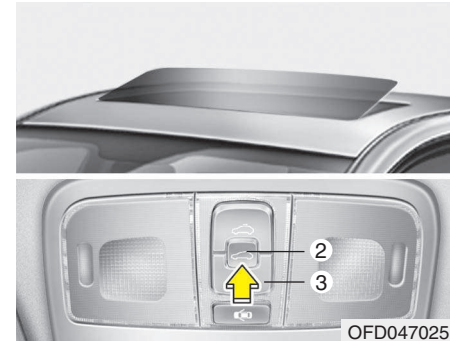

D110200AUN

OFD047025

Tilting the sunroof

To open the sunroof (autotilt feature), press the tilt button (2) on the overhead console for more than 0.5 second.

The sunroof will tilt all the way open. To stop the sunroof tilting at any point, press any sunroof control button.

To close the sunroof, press the close button (3) on the overhead console and hold it until the sunroof is closed.

⚠ WARNING - Sunroof

- Be careful that no heads, hands and body parts are obstructing a closing sunroof.
- Do not extend the face, neck, arms or body outside the sunroof while driving.
- Make sure your hands and head are safely out of the way before closing a sunroof.

⚠ CAUTION

- *Periodically remove any dirt that may accumulate on the guide rail.*
- *If you try to open the sunroof when the temperature is below freezing or when the sunroof is covered with snow or ice, the glass or the motor could be damaged.*
- *While using sunroof for a long time, a dust between sunroof and roof panel can make a noise.
Open the sunroof and remove regularly the dust using clean cloth.*
- *The sunroof is made to slide together with sunshade. Do not leave the sunshade closed while the sunroof is open.*



D110300AUN

Sunshade

The sunshade will be opened with the glass panel automatically when the glass panel is slid. You will have to close it manually if you want it closed.

Resetting the sunroof

Whenever the vehicle battery is disconnected or discharged, or related fuse is blown, you must reset your sunroof system as follows:

1. Turn the ignition switch to the ON position and close the sunroof completely.
2. Release the control button.
3. Press and hold the close button until the sunroof tilts and slightly moves up and down. Then, release the button.
4. Press and hold the close button until the sunroof is operated as follows;

TILT DOWN → SLIDE OPEN →
SLIDE CLOSE

Then, release the control button.

When this is complete, the sunroof system is reset.

※ For more detailed information, contact an authorized HYUNDAI dealer.

CAUTION

If the sunroof is not reset when the vehicle battery is disconnected or discharged, or related fuse is blown, the sunroof may operate improperly.

STEERING WHEEL

D130200BFD-EA

Electric power steering

Power steering uses a motor to assist you in steering the vehicle. If the engine is off or if the power steering system becomes inoperative, the vehicle may still be steered, but it will require increased steering effort.

The motor driven power steering is controlled by power steering control unit which sense the steering wheel torque, steering wheel position and vehicle speed to command the motor.

The steering wheel becomes heavier as the vehicle's speed increases and becomes lighter as the vehicle's speed decreases for the better control of the steering wheel.

Should you notice any change in the effort required to steer during normal vehicle operation, have the power steering checked by an authorised HYUNDAI dealer.

* NOTICE

The following symptoms may occur during normal vehicle operation:

- The EPS warning light does not illuminate.
- The steering wheel becomes heavier after turning the ignition switch on. This happens as the system performs the EPS system diagnostics. When the diagnostics is completed, the steering wheel will return to its normal condition.
- A click noise may be heard from the EPS relay after the ignition switch is turned to the ON or LOCK position.
- Motor noise may be heard when the vehicle is at a stop or at a low driving speed.
- If the Electric Power Steering System does not operate normally, the warning light will illuminate on the instrument cluster. The steering wheel may become difficult to control or operate abnormally. Take your vehicle to an authorised HYUNDAI dealer and have the vehicle checked as soon as possible.
- When you operate the steering wheel in low temperature, abnormal noise could occur. If temperature rises, the noise will disappear. This is a normal condition.

D130300AFD

Tilt steering

A tilt steering wheel allows you to adjust the steering wheel before you drive. You can also raise it to give your legs more room when you exit and enter the vehicle (if equipped).

The steering wheel should be positioned so that it is comfortable for you to drive, while permitting you to see the instrument panel warning lights and gauges.

⚠ WARNING

- Never adjust the angle and height of steering wheel while driving. You may lose your steering control and cause severe personal injury or accidents.
- After adjusting, push the steering wheel both up and down to be certain it is locked in position.

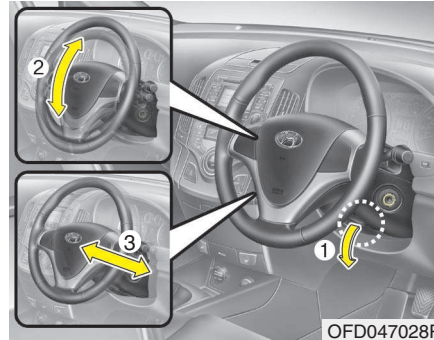

To change the steering wheel angle, pull down the lock release lever (1), adjust the steering wheel to the desired angle (2) and height (if equipped) (3), then pull up the lock-release lever to lock the steering wheel in place. Be sure to adjust the steering wheel to the desired position before driving.

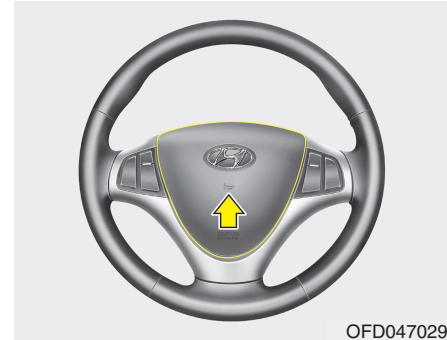

D130500AUN

Horn

To sound the horn, press the horn symbol on your steering wheel. Check the horn regularly to be sure it operates properly.

*** NOTICE**

To sound the horn, press the area indicated by the horn symbol on your steering wheel (see illustration). The horn will operate only when this area is pressed.

⚠ CAUTION

Do not strike the horn severely to operate it, or hit it with your fist. Do not press on the horn with a sharp-pointed object.

MIRRORS

D140100AUN-EA

Inside rearview mirror

Adjust the rearview mirror to centre on the view through the rear window. Make this adjustment before you start driving.

⚠ WARNING - Rear visibility
Do not place objects in the rear seat or cargo area which would interfere with your vision out the rear window.

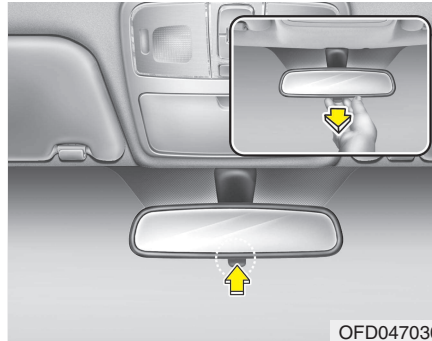

OFD047030

D140101AUN

Day/night rearview mirror

Make this adjustment before you start driving and while the day/night lever is in the day position.

Pull the day/night lever toward you to reduce glare from the headlights of vehicles behind you during night driving.

Remember that you lose some rearview clarity in the night position.

D140102AUN

Electric chromic mirror (ECM) (if equipped)

The electric rearview mirror automatically controls the glare from the headlights of the car behind you in nighttime or low light driving conditions. The sensor mounted in the mirror senses the light level around the vehicle, and automatically controls the headlight glare from vehicles behind you.

When the engine is running, the glare is automatically controlled by the sensor mounted in the rearview mirror.

Whenever the shift lever is shifted into reverse (R), the mirror will automatically go to the brightest setting in order to improve the drivers view behind the vehicle.

⚠ CAUTION

When cleaning the mirror, use a paper towel or similar material dampened with glass cleaner. Do not spray glass cleaner directly on the mirror as that may cause the liquid cleaner to enter the mirror housing.



D140200AUN

Outside rearview mirror

Be sure to adjust mirror angles before driving.

Your vehicle is equipped with both left-hand and right-hand outside rearview mirrors. The mirrors can be adjusted remotely with the remote switch. The mirror heads can be folded back to prevent damage during an automatic car wash or when passing in a narrow street.

To operate the electric rearview mirror

- Press the ON/OFF button (1) to turn the automatic dimming function on. The mirror indicator light will illuminate. Press the ON/OFF button to turn the automatic dimming function off. The mirror indicator light will turn off.
- The mirror defaults to the ON position whenever the ignition switch is turned on.

⚠ WARNING - Rearview mirrors

- **The right outside rearview mirror is convex. In some countries, the left outside rearview mirror is also convex. Objects seen in the mirror are closer than they appear.**
- **Use your interior rearview mirror or direct observation to determine the actual distance of following vehicles when changing lanes.**

⚠ CAUTION

Do not scrape ice off the mirror face; this may damage the surface of the glass. If ice should restrict movement of the mirror, do not force the mirror for adjustment. To remove ice, use a deicer spray, or a sponge or soft cloth with very warm water.

CAUTION

If the mirror is jammed with ice, do not adjust the mirror by force. Use an approved spray de-icer (not radiator antifreeze) to release the frozen mechanism or move the vehicle to a warm place and allow the ice to melt.

WARNING

Do not adjust or fold the outside rearview mirrors while the vehicle is moving. This could result in loss of control, and an accident which could cause death, serious injury or property damage.

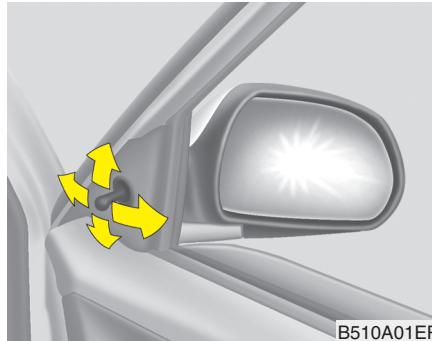

D140201AFD-EA

Remote control

Manual type

The outside rearview mirrors are equipped with a remote control for your convenience. It is operated by the control lever in the bottom front corner of the window.

Before driving away, always check that your mirrors are positioned so you can see behind you, both to the left and right sides, as well as directly behind your vehicle. When using the mirror, always exercise caution when attempting to judge the distance of vehicles behind or along side of you.



Electric type (if equipped)

The electric remote control mirror switch allows you to adjust the position of the left and right outside rearview mirrors. To adjust the position of either mirror, move the lever (1) to R or L to select the right side mirror or the left side mirror, then press a corresponding point on the mirror adjustment control to position the selected mirror up, down, left or right.

After adjustment, put the lever into neutral position to prevent the inadvertent adjustment.

⚠ CAUTION

- *The mirrors stop moving when they reach the maximum adjusting angles, but the motor continues to operate while the switch is depressed. Do not depress the switch longer than necessary, the motor may be damaged.*
- *Do not attempt to adjust the outside rearview mirror by hand. Doing so may damage the internal mirror mechanism.*

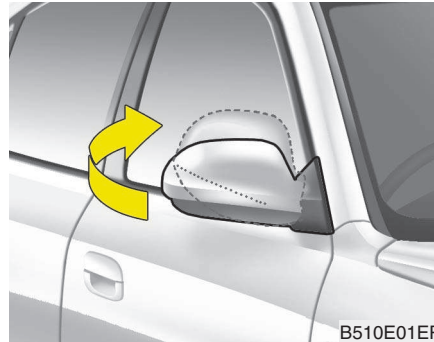

B510E01ER

D140202AFD

Folding the outside rearview mirror

Manual type

To fold outside rearview mirror, grasp the housing of mirror and then fold it toward the rear of the vehicle.



OFD047033R

Electric type (if equipped)

To fold the outside rearview mirror, depress the button.

To unfold it, depress the button again.

⚠ CAUTION

In case of the electric type of outside rearview mirror, don't fold it by hand. It could cause the failure of the motor.

INSTRUMENT CLUSTER



1. Tachometer
2. Engine temperature gauge
3. Fuel gauge
4. Speedometer
5. Turn signal indicators
6. Warning and indicator lights (if equipped)
7. Odometer/Trip computer (if equipped)

* The actual cluster in the vehicle may differ from the illustration.
For more details refer to the "Gauges" in the next pages.

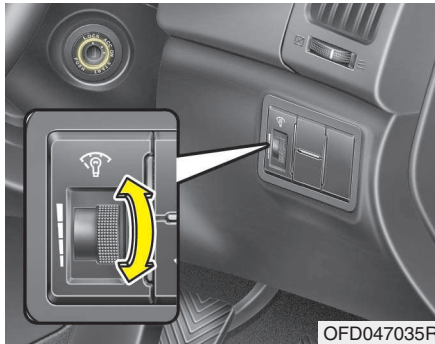

OFD047035R

D150100AFD

Instrument panel illumination (if equipped)

When the vehicle's parking lights or headlights are on, rotate the illumination control knob to adjust the brightness of the instrument panel illumination.

The instrument cluster illumination intensity can be adjusted by rotating the control knob with the headlight switch in any position when the ignition switch is in ON position.



OFD047036

Gauges

D150201AUN-EA

Speedometer

The speedometer indicates the forward speed of the vehicle.

The speedometer is calibrated in kilometers per hour.

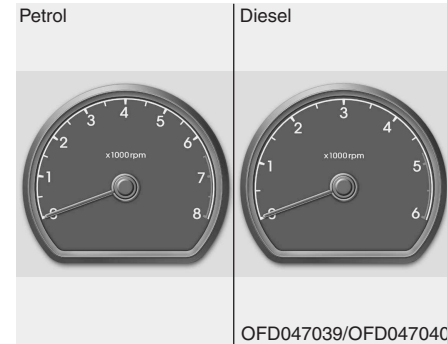

OFD047039/OFD047040

D150202AFD

Tachometer

The tachometer indicates the approximate number of engine revolutions per minute (rpm).

Use the tachometer to select the correct shift points and to prevent lugging and/or over-revving the engine.

The tachometer pointer may move slightly when the ignition switch is in ACC or ON position with the engine OFF. This movement is normal and will not affect the accuracy of the tachometer once the engine is running.

CAUTION

Do not operate the engine within the tachometer's RED ZONE. This may cause severe engine damage.

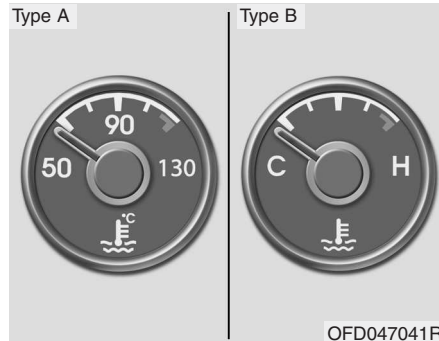

D150203AFD

Engine temperature gauge

This gauge shows the temperature of the engine coolant when the ignition switch is ON.

Do not continue driving with an overheated engine. If your vehicle overheats, refer to “If the engine overheats” in section 6.

CAUTION

If the gauge pointer moves beyond the normal range area toward the “H” or “130°C” position, it indicates overheating that may damage the engine.

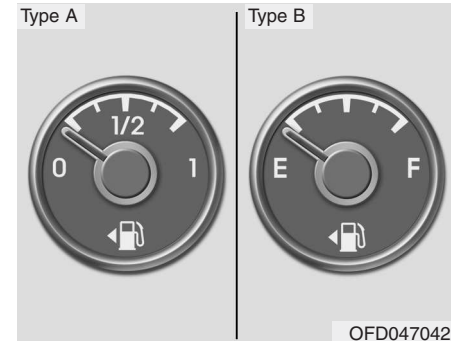
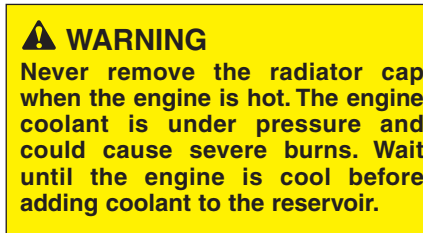

D150204AFD

Fuel gauge

The fuel gauge indicates the approximate amount of fuel remaining in the fuel tank. The fuel tank capacity is given in section 9. The fuel gauge is supplemented by a low fuel warning light, which will illuminate when the fuel tank is nearly empty.

On inclines or curves, the fuel gauge pointer may fluctuate or the low fuel warning light may come on earlier than usual due to the movement of fuel in the tank.

⚠ WARNING - Fuel gauge
 Running out of fuel can expose vehicle occupants to danger. You must stop and obtain additional fuel as soon as possible after the warning light comes on or when the gauge indicator comes close to the E or "0" level.

⚠ CAUTION
 Avoid driving with a very low fuel level. If you run out of fuel, it could cause the engine to misfire and result in excessive loading of the catalytic converter.



OFD047043

D150205AFD

Odometer/Tripmeter (if equipped)

Odometer (km or MI)

The odometer indicates the total distance the vehicle has been driven.

You will also find the odometer useful to determine when periodic maintenance should be performed.

*** NOTICE**

It is forbidden that alteration of the odometer of any vehicle with the intent to change the mileage registered on the odometer. The alteration may void your warranty coverage.



OFD047049

Tripmeter (km or MI)

The tripmeter indicates the distance of individual trip selected by the driver. Tripmeter can be reset to 0 by pressing the TRIP button for 1 second or more, and then releasing.

Features of your vehicle

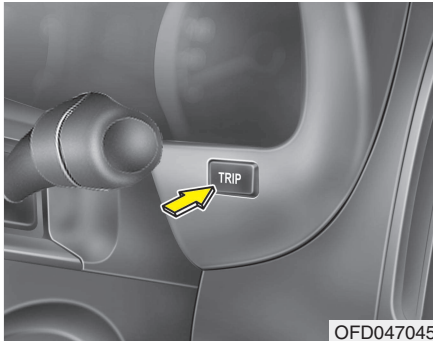

D150206AFD-EA

Trip computer (if equipped)

The trip computer is a microcomputer-controlled driver information system that displays information related to driving, including distance to empty, tripmeter, average fuel consumption and average speed on the display when the ignition switch is in the ON position. All stored driving information (except odometer) is reset if the battery is disconnected. The odometer is always displayed until the display is turned off.

Push the TRIP button for less than 1 second to select distance to empty, average fuel consumption, average speed or tripmeter function as follows :

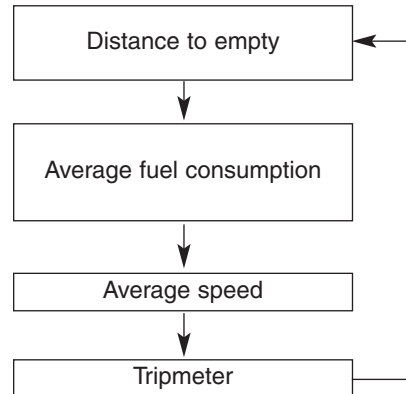

Distance to empty (km or MI)

This mode indicates the estimated distance to empty based on the current fuel in the fuel tank and the amount of fuel delivered to the engine. When the remaining distance is below 50 km (30 miles), "--" will be displayed and the distance to empty indicator will blink.

The meter's working range is from 50 to 999 km (30 to 999 miles).

*** NOTICE**

- If the vehicle is not on level ground or the battery power has been interrupted, the “Distance to empty” function may not operate correctly. The trip computer may not register additional fuel if less than 6 litres (1.6 gallons) of fuel are added to the vehicle.
- The fuel consumption and distance to empty values may vary significantly based on driving conditions, driving habits, and condition of the vehicle.
- The distance to empty value is an estimate of the available driving distance. This value may differ from the actual driving distance available.



Average fuel consumption (l/100 km or MPG)

This mode calculates the average fuel consumption from the total fuel used and the distance since the last average consumption reset. The total fuel used is calculated from the fuel consumption input. For an accurate calculation, drive more than 50 m (0.03 mile).

The meter's working range is from 0.1 to 99.9 l/100 km (0.1 to 99.9 miles per gallon).

Pressing the TRIP button for more than 1 second, when the average fuel consumption is being displayed, clears the average fuel consumption to zero (---).

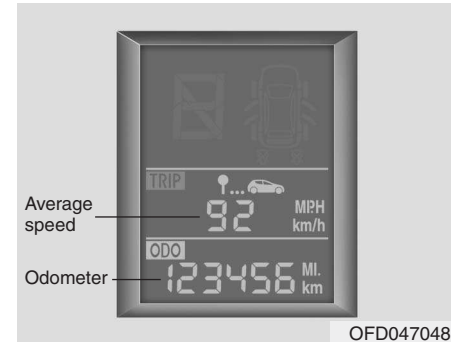

Average speed (km/h or MPH)

This mode calculates the average speed of the vehicle since the last average speed reset.

Even if the vehicle is not in motion, the average speed keeps going while the engine is running.

The meter's working range is from 0 to 240 km/h (0 to 150 mph).

Pressing the TRIP button for more than 1 second, when the average speed is being displayed, clears the average speed to zero (---).



Tripmeter (km or MI)

This mode indicates the distance of individual trip since the last tripmeter reset. The meter's working range is from 0.0 to 999.9 km (miles).

Pressing the TRIP button for more than 1 second when the tripmeter is being displayed clears the tripmeter to zero (0.0).

D150300AFD-EA

Warnings and indicators

All warning lights are checked by turning the ignition switch ON (do not start the engine). Any light that does not illuminate should be checked by an authorised HYUNDAI dealer.

After starting the engine, check to make sure that all warning lights are off. If any are still on, this indicates a situation that needs attention. When releasing the hand brake, the brake system warning light should go off. The fuel warning light will stay on if the fuel level is low.

D150302AFD-EA

Air bag warning light (if equipped)



This warning light will illuminate for approximately 6 seconds each time you turn the ignition switch to the ON position.

This light also comes on when the SRS is not working properly. If the AIRBAG warning light does not come on, or continuously remains on after operating for about 6 seconds when you turned the ignition switch to the ON position or started the engine, or if it comes on while driving, have the SRS inspected by an authorised HYUNDAI dealer.

D150303AFD-EA

Anti-lock brake system (ABS) warning light (if equipped)



This light illuminates if the ignition switch is turned to ON and goes off in approximately 3 seconds if the system is operating normally.

If the ABS warning light remains on, comes on while driving, or does not come on when the ignition switch is turned to the ON position, this indicates that there may be a problem with the ABS.

If this occurs, have your vehicle checked by an authorised HYUNDAI dealer as soon as possible. The normal braking system will still be operational, but without the assistance of the anti-lock brake system.

Electronic brake force distribution (EBD) system warning light



If these two warning lights illuminate at the same time while driving, your vehicle may have a malfunction with ABS and EBD system.

In this case, your ABS and regular brake system may not work normally. Have the vehicle checked by an authorised HYUNDAI dealer as soon as possible.

⚠ WARNING

If the both ABS and Brake warning lights are on and stay on, your vehicle's brake system will not work normally. So you may experience an unexpected and dangerous situation during sudden braking. In this case, avoid high speed driving and abrupt braking. Have your vehicle checked by an authorised HYUNDAI dealer as soon as possible.

D150304AFD-EA

Seat belt warning



As a reminder to the driver and front passenger, the driver's and front passenger's seat belt warning lights will illuminate for approximately 6 seconds each time you turn the ignition switch ON, regardless of belt fastening.

If the driver's or front passenger's seat belt is not fastened when the ignition switch is turned ON or if it is disconnected after the ignition switch is turn ON, the corresponding seat belt warning light will illuminate or blink until the belt is fastened.

If the driver's or front passenger's seat belt is not fastened when the ignition switch is turned ON and you drive over 20 km/h, the seat belt warning chime will sound for approximately 100 seconds.

If the driver's or front passenger's seat belt is disconnected after the ignition switch is turn ON and you drive over 20 km/h, the seat belt warning chime will sound for approximately 100 seconds.

After 100 seconds, if the seat belt is connected and disconnected again, the seat belt warning chime will sound again.

Features of your vehicle

D150305AFD

Turn signal indicator lights

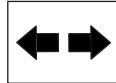

The blinking green arrows on the instrument panel show the direction indicated by the turn signals. If the arrow comes on but does not blink, blinks more rapidly than normal, or does not illuminate at all, a malfunction in the turn signal system is indicated. Your dealer should be consulted for repairs.

This indicator also blinks when the hazard warning switch is turned on.

D150306AUN

High beam indicator

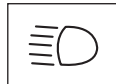

This indicator illuminates when the headlights are on and in the high beam position or when the turn signal lever is pulled into the Flash-to-Pass position.

D150307AFD-EA

Engine oil pressure warning



This warning light indicates the engine oil pressure is low. If the warning light illuminates while driving:

1. Drive safely to the side of the road and stop.
2. With the engine off, check the engine oil level. If the level is low, add oil as required.

If the warning light remains on after adding oil or if oil is not available, call an authorised HYUNDAI dealer.

⚠ CAUTION

If the engine is not stopped immediately after the engine oil pressure warning light is illuminated, severe damage could result.

⚠ CAUTION

If the oil pressure warning light stays on while the engine is running, serious engine damage may result. The oil pressure warning light comes on whenever there is insufficient oil pressure. In normal operation, it should come on when the ignition switch is turned on, then go out when the engine is started. If the oil pressure warning light stays on while the engine is running, there is a serious malfunction.

If this happens, stop the car as soon as it is safe to do so, turn off the engine and check the oil level. If the oil level is low, fill the engine oil to the proper level and start the engine again. If the light stays on with the engine running, turn the engine off immediately. In any instance where the oil light stays on when the engine is running, the engine should be checked by an authorised HYUNDAI dealer before the car is driven again.

D150308AFD-EA

Hand brake & brake fluid warning



Hand brake warning

This light is illuminated when the hand brake is applied with the ignition switch in the START or ON position. The warning light should go off when the hand brake is released.

Low brake fluid level warning

If the warning light remains on, it may indicate that the brake fluid level in the reservoir is low.

If the warning light remains on:

1. Drive carefully to the nearest safe location and stop your vehicle.
2. With the engine stopped, check the brake fluid level immediately and add fluid as required. Then check all brake components for fluid leaks.
3. Do not drive the vehicle if leaks are found, the warning light remains on or the brakes do not operate properly. Have it towed to any authorised HYUNDAI dealer for a brake system inspection and necessary repairs.

Your vehicle is equipped with dual-diagonal braking systems. This means you still have braking on two wheels even if one of the dual systems should fail. With only one of the dual systems working, more than normal pedal travel and greater pedal pressure are required to stop the car. Also, the car will not stop in as short a distance with only a portion of the brake system working. If the brakes fail while you are driving, shift to a lower gear for additional engine braking and stop the car as soon as it is safe to do so.

To check bulb operation, check whether the hand brake and brake fluid warning light illuminates when the ignition switch is in the ON position.

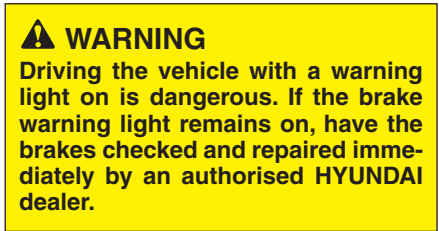

D150309AUN

Front fog light indicator (if equipped)



This light comes on when the front fog lights are ON.

D150310AFD

Rear fog light Indicator (if equipped)



This light comes on when the rear fog lights are ON.

D150312AUN

Shift pattern indicators (if equipped)



The indicator displays which automatic transaxle shift position is selected.

Features of your vehicle

D150313AFD-EA

Charging system warning

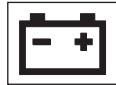

This warning light indicates a malfunction of either the generator or electrical charging system.

If the warning light comes on while the vehicle is in motion:

1. Drive to the nearest safe location.
2. With the engine off, check the generator drive belt for looseness or breakage.
3. If the belt is adjusted properly, a problem exists somewhere in the electrical charging system. Have an authorised HYUNDAI dealer correct the problem as soon as possible.

D150315AUN

Tailgate open warning light



This warning light blinks when the tailgate is not closed securely with the ignition in any position.

D150316AUN

Door ajar warning light



This warning light illuminates when a door is not closed securely with the ignition in any position.

D150317AFD-EA

Immobiliser indicator (if equipped)



This light illuminates when the immobiliser key is inserted and turned to the ON position to start the engine.

At this time, you can start the engine. The light goes out after the engine is running. If this light blinks when the ignition switch is in the ON position before starting the engine, have the system checked by an authorised HYUNDAI dealer.

D150318AFD

Low fuel level warning



This warning light indicates the fuel tank is nearly empty. When it comes on, you should add fuel as soon as possible. Driving with the fuel level warning light on or with the fuel level below “E” (or 0) can cause the engine to misfire and damage the catalytic converter.

D150319AUN

Low washer fluid level warning indicator (if equipped)



This warning light indicates the washer fluid reservoir is near empty. Refill the washer fluid as soon as possible.

D150320AFD-EA

Malfunction indicator lamp (MIL) (check engine light)



This indicator light is part of the Engine Control System which monitors various emission control system components. If this light illuminates while driving, it indicates that a potential problem has been detected somewhere in the emission control system.

This light will also illuminate when the ignition switch is turned to the ON position, and will go out in a few seconds after the engine is started. If it illuminates while driving, or does not illuminate when the ignition key is turned to the ON position, take your vehicle to your nearest authorised HYUNDAI dealer and have the system checked.

Generally, your vehicle will continue to be drivable, but have the system checked by an authorised HYUNDAI dealer promptly.

⚠ CAUTION

- *Prolonged driving with the Emission Control System Malfunction Indicator Light illuminated may cause damage to the emission control systems which could effect drivability and/or fuel economy.*
- *If the Emission Control System Malfunction Indicator Light illuminates, potential catalytic converter damage is possible. This could result in loss of engine power. Have the Engine Control System inspected as soon as possible by an authorised HYUNDAI dealer.*

⚠ CAUTION - Diesel engine (if equipped with DPF)

When the malfunction indicator light is blinks, it may stop blinking after driving the vehicle at more than 60km/h (37 mph) or at more than second gear with 1500 ~ 2000 engine rpm for a certain time (for about 25 minutes).

If the malfunction indicator light continues to be blinked in spite of the procedure, please visit an authorised HYUNDAI dealer and then check the DPF system.

If you continue to drive with the malfunction indicator light blinking for a long time, the DPF system can be damaged and fuel consumption can be worsen.

D150323AUN-EE

ESP indicator (Electronic Stability Program) (if equipped)

ESP

The ESP indicator will illuminate when the ignition switch is turned ON, but should go off after approximately 3 seconds. When the ESP is on, it monitors the driving conditions and under normal driving conditions, the ESP light will remain off. When a slippery or low traction condition is encountered, the ESP will operate, and the ESP indicator will blink to indicate the ESP is operating.

Features of your vehicle

D150324AFD-EA

**ESP OFF indicator
(if equipped)**



The ESP OFF indicator will illuminate when the ignition switch is turned ON, but should go off after approximately 3 seconds. To switch to ESP OFF mode, press the ESP OFF button. The ESP OFF indicator will illuminate indicating the ESP is deactivated. If this indicator stays on when ESP OFF is not selected, the ESP may have a malfunction. Take your car to an authorised HYUNDAI dealer and have the system checked.

* NOTICE

After reconnecting or recharging a discharged battery, the ESP OFF indicator may illuminate. In this case, turn the steering wheel 360 degrees to the left and 360 degrees to the right while the ignition switch is in the ON position. Then, restart the engine after the ignition is off. If the ESP OFF indicator does not turn off, have the system checked by an authorised HYUNDAI dealer as soon as possible.

D150325AFD

**Cruise indicator (if equipped)
CRUISE indicator**



The indicator light illuminates when the cruise control system is enabled.

The cruise indicator light in the instrument cluster is illuminated when the cruise control ON/OFF button on the steering wheel is pushed.

The indicator light turns off when the cruise control ON/OFF button is pushed again. For more Information about the use of cruise control, refer to section 5, "Cruise control system".

Cruise SET indicator



The indicator light illuminates when the cruise function switch (COAST/SET or RES/ACCEL) is ON.

The cruise SET indicator light in the instrument cluster is illuminated when the cruise control switch (COAST/SET or RES/ACCEL) is pushed. The cruise SET indicator light does not illuminate when the cruise control switch (CANCEL) is pushed or the system is disengaged.

D150327AUN

**Key reminder warning chime
(if equipped)**

If the driver's door is opened while the ignition key is left in the ignition switch (ACC or LOCK position), the key reminder warning chime will sound. This is to prevent you from locking your keys in the vehicle. The chime sounds until the key is removed from the ignition switch or the driver's door is closed.

D150328AFD-EA

**Glow indicator
(Diesel engine)**



The indicator light illuminates when the ignition switch is placed at the ON position. The engine can be started after the preheat indicator light goes off. The illuminating time varies with the water temperature, air temperature and battery condition.

*** NOTICE**

If the engine was not started within 10 seconds after the preheating is completed, turn the ignition key once more to the LOCK position during 10 seconds, and then to the ON position, in order to preheat again.

⚠ CAUTION

If the preheat indicator light continues to illuminate or flash on and off after the engine has warmed up or while driving, check the system by an authorised HYUNDAI dealer as soon as possible.

D150329AFD-EA

**Fuel filter warning light
(Diesel engine)**



This warning light illuminates for 3 seconds after the ignition switch is set to the ON position and then it will go out. If it lights up while the engine is running, it indicates that water has accumulated inside the fuel filter. If this happens, remove the water from the fuel filter. For more Information, refer to section 7, "Fuel filter".

⚠ CAUTION

When the fuel filter warning light is illuminated, engine power (vehicle speed & idle speed) may decrease. If you keep driving with the warning light on, you can damage your vehicle's engine parts and injection system of the Common Rail. If this occurs, have your vehicle checked by an authorised HYUNDAI dealer as soon as possible.

D150334AFD-EA

**Electric power steering
(EPS) system warning light**



This indicator light comes on after the ignition key is turned to the ON position and then it will go out after the engine is started.

This light also comes on when the EPS has some troubles. If it comes on while driving, have your vehicle inspected by an authorised HYUNDAI dealer.

REAR PARKING ASSIST SYSTEM (IF EQUIPPED)

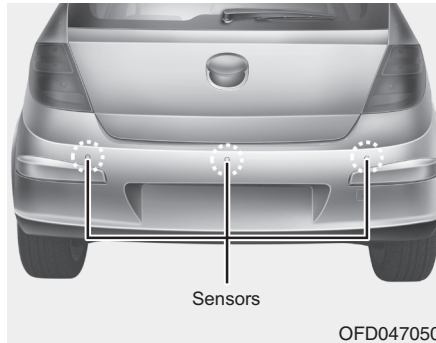

D170000AEN

The rear parking assist system assists the driver during backward movement of the vehicle by chiming if any object is sensed within a distance of 120 cm (47 in.) behind the vehicle. This system is a supplemental system and it is not intended to nor does it replace the need for extreme care and attention of the driver. The sensing range and objects detectable by the back sensors are limited. Whenever backing-up, pay as much attention to what is behind you as you would in a vehicle without a rear parking assist system.

⚠ WARNING

The rear parking assist system is a supplementary function only. The operation of the rear parking assist system can be affected by several factors (including environmental conditions). It is the responsibility of the driver to always check the area behind the vehicle before and while backing up.

Operation of the rear parking assist system

D170101AEN

Operating condition

- This system will activate when backing up with the ignition switch ON.
If the vehicle is moving at a speed over 5 km/h (3 mph), the system may not be activated correctly.
- The sensing distance while the rear parking assist system is in operation is approximately 120 cm (47 in.).
- When more than two objects are sensed at the same time, the closest one will be recognized first.

D170102AEN

Types of warning sound

- When an object is 120 cm to 81 cm (47 in. to 32 in.) from the rear bumper: Buzzer beeps intermittently.
- When an object is 80 cm to 41 cm (31 in. to 16 in.) from the rear bumper: Buzzer beeps more frequently.
- When an object is within 40 cm (15 in.) of the rear bumper: Buzzer sounds continuously.

D170200AEN

Non-operational conditions of rear parking assist system

The rear parking assist system may not operate properly when:

1. Moisture is frozen to the sensor. (It will operate normally when the moisture has been cleared.)
2. The sensor is covered with foreign matter, such as snow or water, or the sensor cover is blocked. (It will operate normally when the material is removed or the sensor is no longer blocked.)
3. Driving on uneven road surfaces (unpaved roads, gravel, bumps, gradient).
4. Objects generating excessive noise (vehicle horns, loud motorcycle engines, or truck air brakes) are within range of the sensor.

5. Heavy rain or water spray exists.
6. Wireless transmitters or mobile phones are within range of the sensor.
7. The sensor is covered with snow.
8. Trailer towing

The detecting range may decrease when:

1. The sensor is stained with foreign matter such as snow or water. (The sensing range will return to normal when removed.)
2. Outside air temperature is extremely hot or cold.

The following objects may not be recognized by the sensor:

1. Sharp or slim objects such as ropes, chains or small poles.
2. Objects which tend to absorb the sensor frequency such as clothes, spongy material or snow.
3. Undetectable objects smaller than 1 m (40 in.) in height and narrower than 14 cm (6 in.) in diameter.

D170300AEN

Rear parking assist system precautions

- The rear parking assist system may not sound sequentially depending on the speed and shapes of the objects detected.
- The rear parking assist system may malfunction if the vehicle bumper height or sensor installation has been modified or damaged. Any non-factory installed equipment or accessories may also interfere with the sensor performance.
- The sensor may not recognize objects less than 40 cm (15 in.) from the sensor, or it may sense an incorrect distance. Use caution.
- When the sensor is frozen or stained with snow, dirt, or water, the sensor may be inoperative until the stains are removed using a soft cloth.
- Do not push, scratch or strike the sensor. Sensor damage could occur.

*** NOTICE**

This system can only sense objects within the range and location of the sensors; It can not detect objects in other areas where sensors are not installed. Also, small or slim objects, such as poles or objects located between sensors may not be detected by the sensors. Always visually check behind the vehicle when backing up. Be sure to inform any drivers of the vehicle that may be unfamiliar with the system regarding the systems capabilities and limitations.

 WARNING

Pay close attention when the vehicle is driven close to objects on the road, particularly pedestrians, and especially children. Be aware that some objects may not be detected by the sensors, due to the object's distance, size or material, all of which can limit the effectiveness of the sensor. Always perform a visual inspection to make sure the vehicle is clear of all obstructions before moving the vehicle in any direction.

D170400AFD-EA

Self-diagnosis

If you don't hear an audible warning sound or if the buzzer sounds intermittently when shifting the gear to the R (Reverse) position, this may indicate a malfunction in the rear parking assist system. If this occurs, have your vehicle checked by an authorised HYUNDAI dealer as soon as possible.

⚠ WARNING

Your new vehicle warranty does not cover any accidents or damage to the vehicle or injuries to its occupants due to a rear parking assist system malfunction. Always drive safely and cautiously.

HAZARD WARNING FLASHER

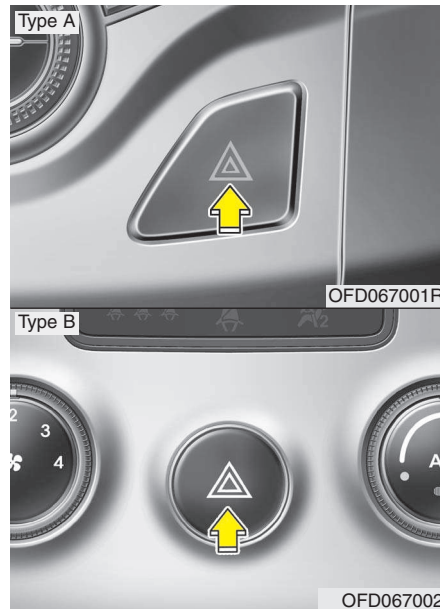

D180000AUN

The hazard warning flasher should be used whenever you find it necessary to stop the car in a hazardous location. When you must make such an emergency stop, always pull off the road as far as possible.

The hazard warning lights are turned on by pushing in the hazard switch. This causes all turn signal lights to blink. The hazard warning lights will operate even though the key is not in the ignition switch.

To turn the hazard warning lights off, push the switch a second time.

LIGHTING

D190100AUN-EA

Battery saver function

- The purpose of this feature is to prevent the battery from being accidentally discharged. The system automatically turns off the parking lights when the driver removes the ignition key and opens the driver's door.
- If required, to keep the parking lights on when the ignition key is removed, perform the following :
 - 1) Open the driver's door.
 - 2) Turn the parking lights OFF and ON again using the light switch on the steering column.

Headlight escort function (if equipped)

If you turn the ignition switch to the ACC or LOCK position with the headlights ON, the headlights remain on for about 20 minutes. However, if the driver's door is opened and closed, the headlights are turned off after 30 seconds.

The headlights can be turned off by pressing the lock button on the transmitter twice or turning the light switch to the OFF position.

For deactivation or activation of this feature, contact an authorized HYUNDAI dealer.

CAUTION

If the driver gets out of the vehicle through other doors (except driver's door), the battery saver function does not operate and the headlight escort function does not turn off automatically. Therefore, it causes the battery to be discharged. In this case, make sure to turn off the lamp before getting out of the vehicle.

Headlight welcome function (if equipped)

If you press the door unlock button on the transmitter when the light switch is in the headlight or AUTO (in the dark outside) position and all doors (and tailgate) are closed, the headlight will come on for about 15 seconds. At this time, if you press the door lock or unlock button on the transmitter, the headlights will turn off immediately.

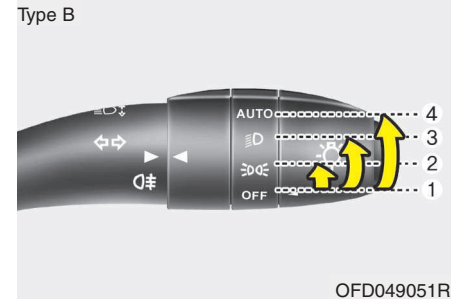
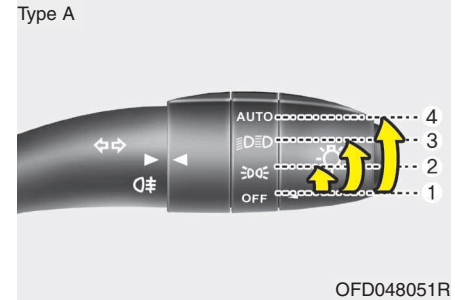

D190400AUN

Lighting control

The light switch has a Headlight and a Parking light position. To operate the lights, turn the knob at the end of the control lever to one of the following positions:

- (1) OFF position
- (2) Parking light position
- (3) Headlight position
- (4) Auto light position (if equipped)

Features of your vehicle

Type A

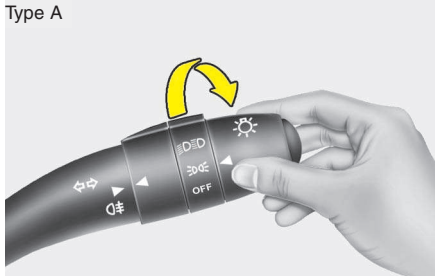

OFD048052R

Type B

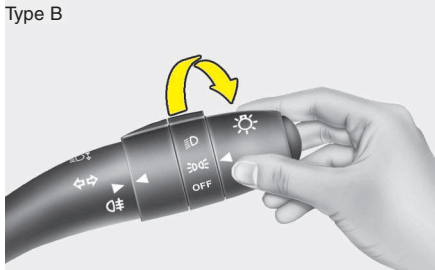

OFD049052R

D190401AUN

Parking light position (☀)

When the light switch is in the parking light position (1st position), the tail, position, license and instrument panel lights are ON.

Type A



OFD048053R

Type B

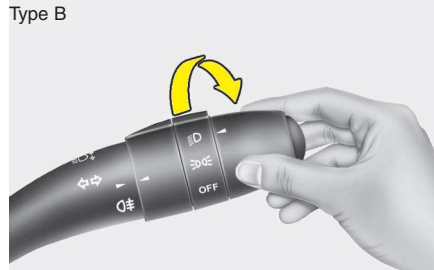

OFD049053R

D190402AUN

Headlight position (☀ or ☀)

When the light switch is in the headlight position (2nd position) the head, tail, position, license and instrument panel lights are ON.

*** NOTICE**

The ignition switch must be in the ON position to turn on the headlights.

Type A

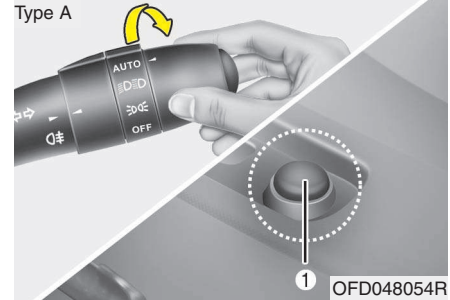

OFD048054R

Type B

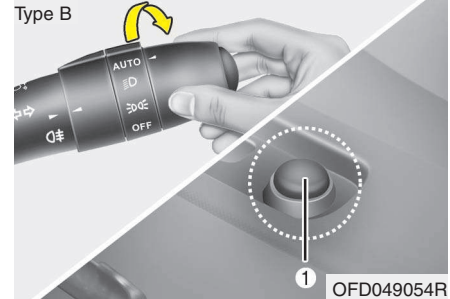

OFD049054R

D190403AUN

Auto light position (if equipped)

When the light switch is in the AUTO light position, the taillights and headlights will be turned ON or OFF automatically depending on the amount of light outside the vehicle.

CAUTION

- *Never place anything over sensor (1) located on the instrument panel, this will ensure better auto-light system control.*
- *Don't clean the sensor using a window cleaner, the cleaner may leave a light film which could interfere with sensor operation.*
- *If your vehicle has window tint or other types of metallic coating on the front windshield, the Auto light system may not work properly.*

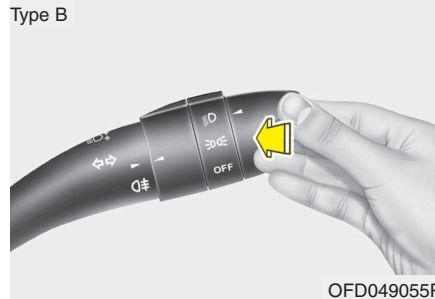
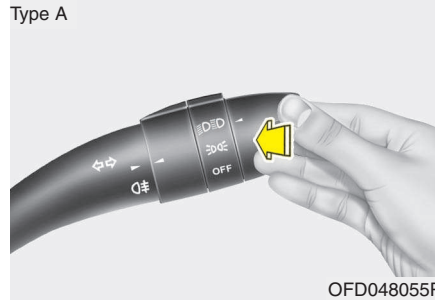

D190500AUN

High - beam operation

To turn on the high beam headlights, push the lever away from you. Pull it back for low beams. The high-beam indicator will light when the headlight high beams are switched on. To prevent the battery from being discharged, do not leave the lights on for a prolonged time while the engine is not running.

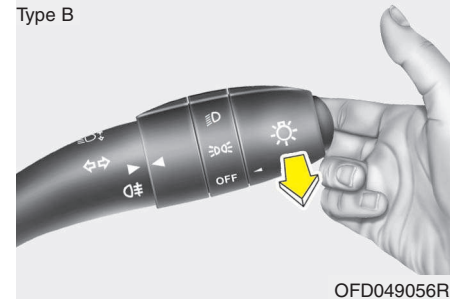
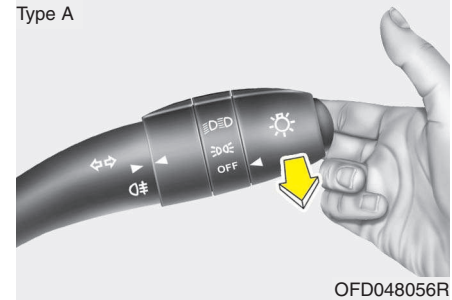

Flashing headlights

To flash the headlights, pull the lever towards you. It will return to the normal (low-beam) position when released. The headlight switch does not need to be on to use this flashing feature.

Features of your vehicle

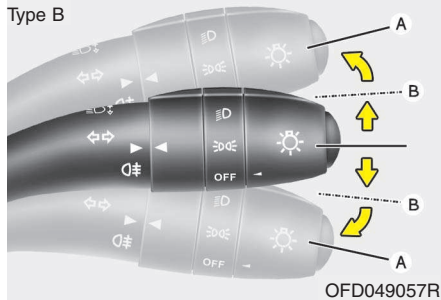
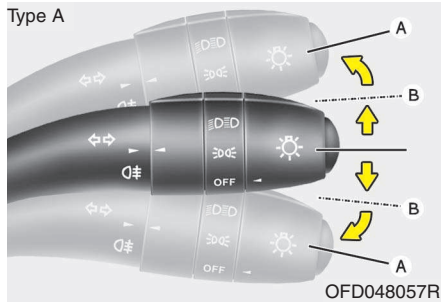

D190600AUN

Turn signals and lane change signals

The ignition switch must be on for the turn signals to function. To turn on the turn signals, move the lever up or down (A). Green arrow indicators on the instrument panel indicate which turn signal is operating.

They will self-cancel after a turn is completed. If the indicator continues to flash after a turn, manually return the lever to the OFF position.

To signal a lane change, move the turn signal lever slightly and hold it in position (B). The lever will return to the OFF position when released.

If an indicator stays on and does not flash or if it flashes abnormally, one of the turn signal bulbs may be burned out and will require replacement.

One-touch triple turn signal (if equipped)

To activate an one-touch triple turn signal move the turn signal lever slightly and then release it. The lane change signals will blink 3 times.

*** NOTICE**

If an indicator flash is abnormally quick or slow, bulb may be burned out or have a poor electrical connection in the circuit.



D190700AFD

Front fog light (if equipped)

Fog lights are used to provide improved visibility and avoid accidents when visibility is poor due to fog, rain or snow etc. The fog lights will turn on when fog light switch (1) is turned to on position (2) after the parklight is turned on.

To turn off the fog lights, turn the switch to on position (2) again.

WIPERS AND WASHERS

Windshield wiper/washer

Type A

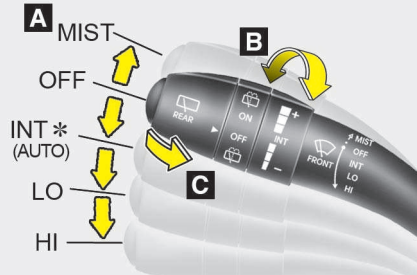

Type B

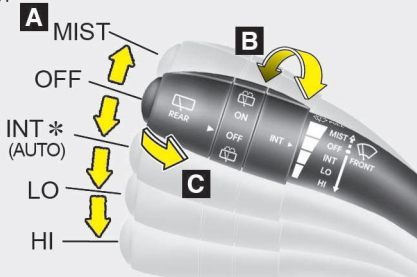

Rear window wiper/washer (if equipped)

Type A

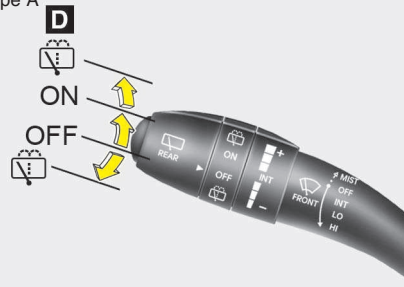

Type B

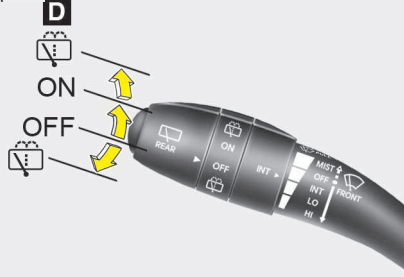



A : Wiper speed control

- MIST – Single wipe
- OFF – Off
- INT / AUTO – Intermittent wipe/
Auto control wipe*
- LO – Normal wiper speed
- HI – Fast wiper speed

B : Intermittent or Auto control wipe time adjustment

C : Wash with brief wipes

D : Rear wiper/washer control

-  – Spraying washer fluid
- ON – Normal wipe operation
- OFF – Off
-  – Wash with brief wipes

*: if equipped

OFD047900R/OFD049900R/OFD0489001R/OFD0499001R

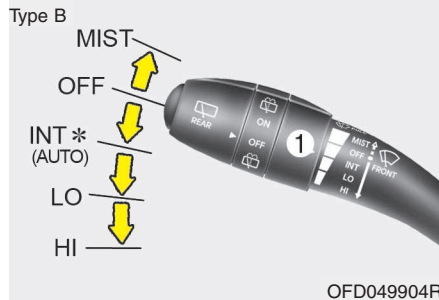
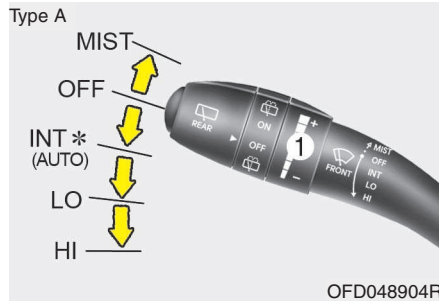

D200100AFD

Windshield wipers

Operates as follows when the ignition switch is turned ON.

MIST : For a single wiping cycle, push the lever upward and release it with the lever in the OFF position. The wipers will operate continuously if the lever is pushed upward and held.

OFF : Wiper is not in operation.

INT / AUTO* : Wiper operates intermittently at the same wiping intervals. Use this mode in a light rain or mist. To vary the speed setting, turn the speed control knob(1).

LO : Normal wiper speed

HI : Fast wiper speed

* NOTICE

If there is heavy accumulation of snow or ice on the windshield, defrost the windshield for about 10 minutes, or until the snow and/or ice is removed before using the windshield wipers to ensure proper operation.

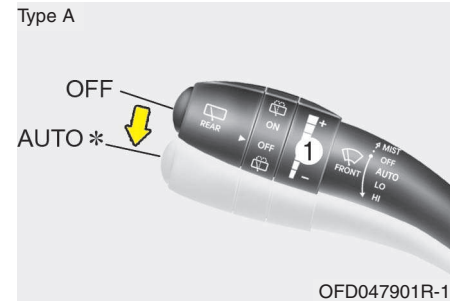

D200101AEN

Auto control (if equipped)

The rain sensor located on the upper end of the windshield glass senses the amount of rainfall and controls the wiping cycle for the proper interval. The more it rains, the faster the wiper operates. When the rain stops, the wiper stops. To vary the speed setting, turn the speed control knob (1).

If the ignition switch is turned ON when the wiper switch is set in AUTO mode, or the wiper switch is set in AUTO mode when the ignition switch is ON, or the speed control knob is turned upward when the wiper switch is in AUTO mode, the wiper will operate once to perform a self-check of the system. Set the wiper to 0 position when the wiper is not in use.

CAUTION

When the ignition switch is ON and the windshield wiper switch is placed in the AUTO mode, use caution in the following situations to avoid any injury to the hands or other parts of the body:

- *Do not touch the upper end of the windshield glass facing the rain sensor.*
- *Do not wipe the upper end of the windshield glass with a damp or wet cloth.*
- *Do not put pressure on the windshield glass.*

CAUTION

When washing the vehicle, set the wiper switch in the OFF position to stop the auto wiper operation.

The wiper may operate and be damaged if the switch is set in the AUTO mode while washing the vehicle.

Do not remove the sensor cover located on the upper end of the passenger side windshield glass. Damage to system parts could occur and may not be covered by your vehicle warranty.

When starting the vehicle in winter, set the wiper switch in the OFF position. Otherwise, wipers may operate and ice may damage the windshield wiper blades. Always remove all snow and ice and defrost the windshield properly prior to operating the windshield wipers.

Type A

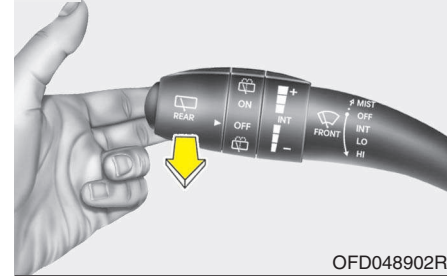

OFD048902R

Type B

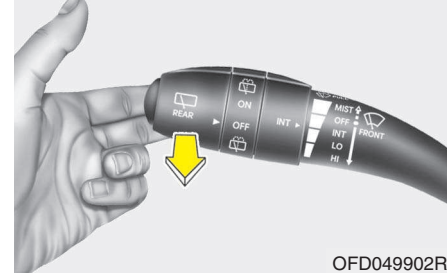

OFD049902R

D200200AUN-EA

Windshield washers

In the OFF position, pull the lever gently toward you to spray washer fluid on the windshield and to run the wipers 1-3 cycles.

Use this function when the windshield is dirty.

The spray and wiper operation will continue until you release the lever.

If the washer does not work, check the washer fluid level. If the fluid level is not sufficient, you will need to add appropriate non-abrasive windshield washer fluid to the washer reservoir.

The reservoir filler neck is located in the front of the engine compartment on the driver side.

CAUTION

To prevent possible damage to the washer pump, do not operate the washer when the fluid reservoir is empty.

WARNING

Do not use the washer in freezing temperatures without first warming the windshield with the defrosters; the washer solution could freeze on contact with the windshield and obscure your vision.

CAUTION

- To prevent possible damage to the wipers or windshield, do not operate the wipers when the windshield is dry.
- To prevent damage to the wiper blades, do not use petrol, kerosene, paint thinner, or other solvents on or near them.
- To prevent damage to the wiper arms and other components, do not attempt to move the wipers manually.

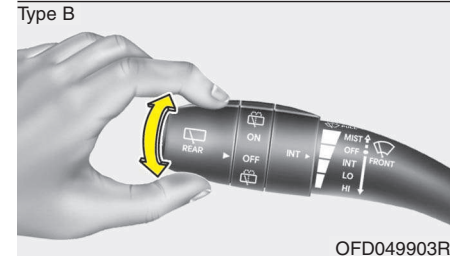

D200300AFD

Rear window wiper and washer switch (if equipped)

The rear window wiper and washer switch is located at the end of the wiper and washer switch lever. Turn the switch to desired position to operate the rear wiper and washer.

- Spraying washer fluid and wiping
- ON - Normal wiper operation
- OFF - Wiper is not in operation
- Spraying washer fluid and wiping

INTERIOR LIGHT

D210000AUN

CAUTION

Do not use the interior lights for extended periods when engine is not running. It may cause battery discharge.

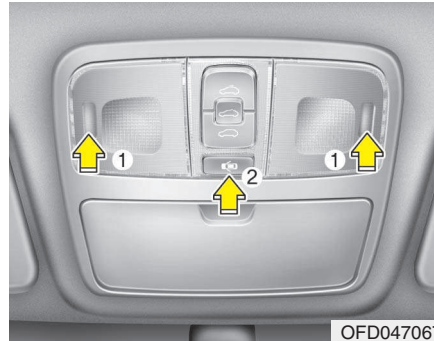

OFD047067

D210100AFD

Map lamp (if equipped)

Push in the map lamp lens (1) to turn the light on or off. This light produces a spot beam for convenient use as a map lamp at night or as a personal lamp for the driver and the passenger.

• DOOR (2) :

In the DOOR position, the light comes on when any door is opened regardless of the ignition switch position.

When doors are unlocked by the transmitter, the light comes on for approximately 30 seconds as long as any door is not open. The light goes out gradually after approximately 30 seconds if the door is closed. However, if the ignition switch is ON or all doors are locked, the light will turn off immediately.

If a door is opened with the ignition switch in the ACC or LOCK position, the light stays on for about 20 minutes. However, if a door is opened with the ignition switch in the ON position, the light stays on continuously.



OFD047068

D210200AFD

Dome lamp

• OFF (1) :

In the OFF position, the light stays off at all times even when a door is open.

• DOOR (2) :

In the DOOR position, the light comes on when any door is opened regardless of the ignition switch position.

When doors are unlocked by the transmitter, the light comes on for approximately 30 seconds as long as any door is not open. The light goes out gradually after approximately 30 seconds if the door is closed. However, if the ignition switch is ON or all doors are locked, the light will turn off immediately.

If a door is opened with the ignition switch in the ACC or LOCK position, the light stays on for about 20 minutes. However, if a door is opened with the ignition switch in the ON position, the light stays on continuously.

• ON (3):

In the ON position, the light stays on at all times.

CAUTION

Do not leave the switch in this position for an extended period of time when the vehicle is not running.

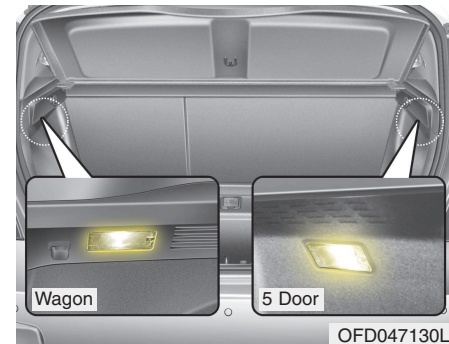

OFD047130L

D210300AFD

Luggage room lamp

The luggage room lamp comes on when the tailgate is opened.

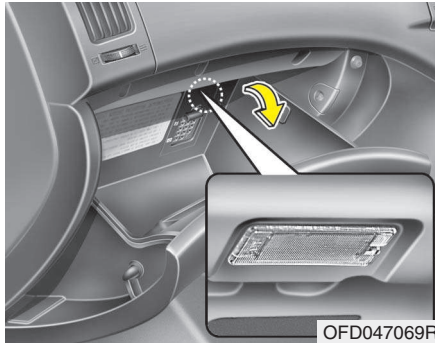

D210500AUN

Glove box lamp (if equipped)

The glove box lamp comes on when the glove box is opened.

The parking lights or headlights must be ON for the glove box lamp to function.

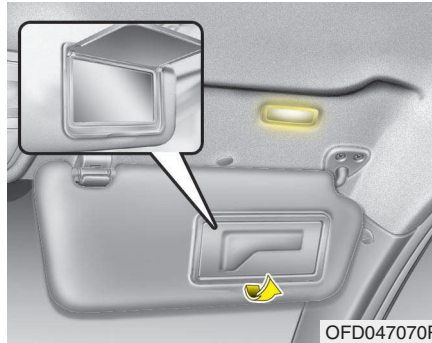

D210600AUN

Vanity mirror lamp (if equipped)

Opening the lid of the vanity mirror will automatically turn on the mirror light.

DEFROSTER

D220000AUN

CAUTION

To prevent damage to the conductors bonded to the inside surface of the rear window, never use sharp instruments or window cleaners containing abrasives to clean the window.

* NOTICE

If you want to defrost and defog on the front windshield, refer to “Windshield Defrosting and Defogging” in this section.

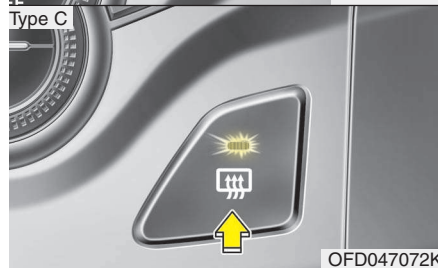
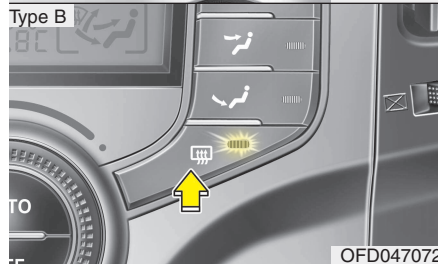
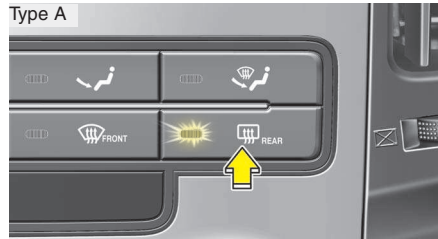

D220100AUN-EA

Rear window defroster

The defroster heats the window to remove frost, fog and thin ice from the interior and exterior of the rear window, while engine is running.

To activate the rear window defroster, press the rear window defroster button located in the centre facia switch panel. The indicator on the rear window defroster button illuminates when the defroster is ON.

If there is heavy accumulation of snow on the rear window, brush it off before operating the rear defroster.

The rear window defroster automatically turns off after approximately 20 minutes or when the ignition switch is turned off. To turn off the defroster, press the rear window defroster button again.

D220101AUN

**Outside mirror defroster
(if equipped)**

If your vehicle is equipped with the outside mirror defrosters, they will operate at the same time you turn on the rear window defroster.

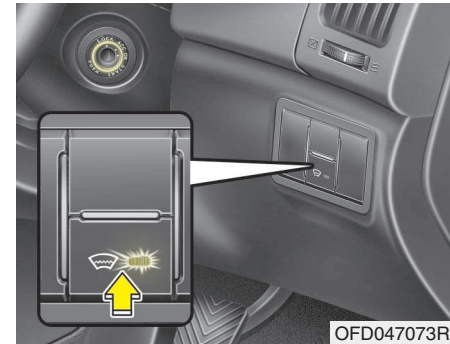

D220200AUN

**Front windshield deicer
(if equipped)**

The engine must be running to enable this feature. To activate the front windshield deicer, press the front windshield deicer button. The indicator on the button illuminates when the deicer is ON. The front windshield deicer automatically turns off after 20 minutes or when the ignition switch is turned off. To turn off the deicer, press the front windshield deicer button again.

MANUAL CLIMATE CONTROL SYSTEM (IF EQUIPPED)

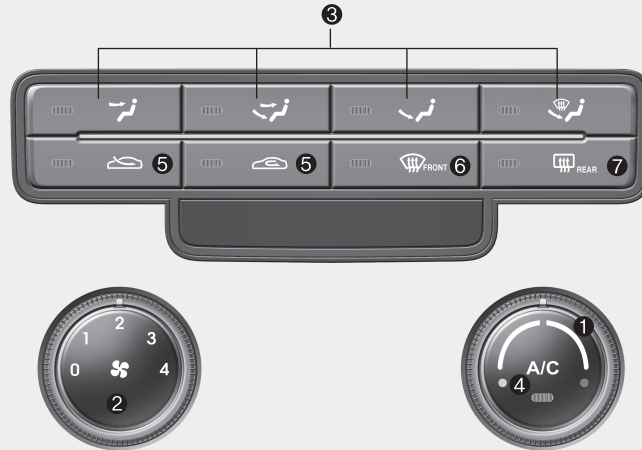

1. Temperature control knob
2. Fan speed control knob
3. Mode buttons

4. Air conditioning button (if equipped)
5. Air intake control buttons
6. Front window defroster button
7. Rear window defroster button

OFD040074

D230100AUN

Heating and air conditioning

1. Start the engine.
2. Set the mode to the desired position.
3. Set the temperature control to the desired position.
4. Set the air intake control to the outside (fresh) air position.
5. Set the fan speed control to the desired speed.
6. If air conditioning is desired, turn the air conditioning system (if equipped) on.

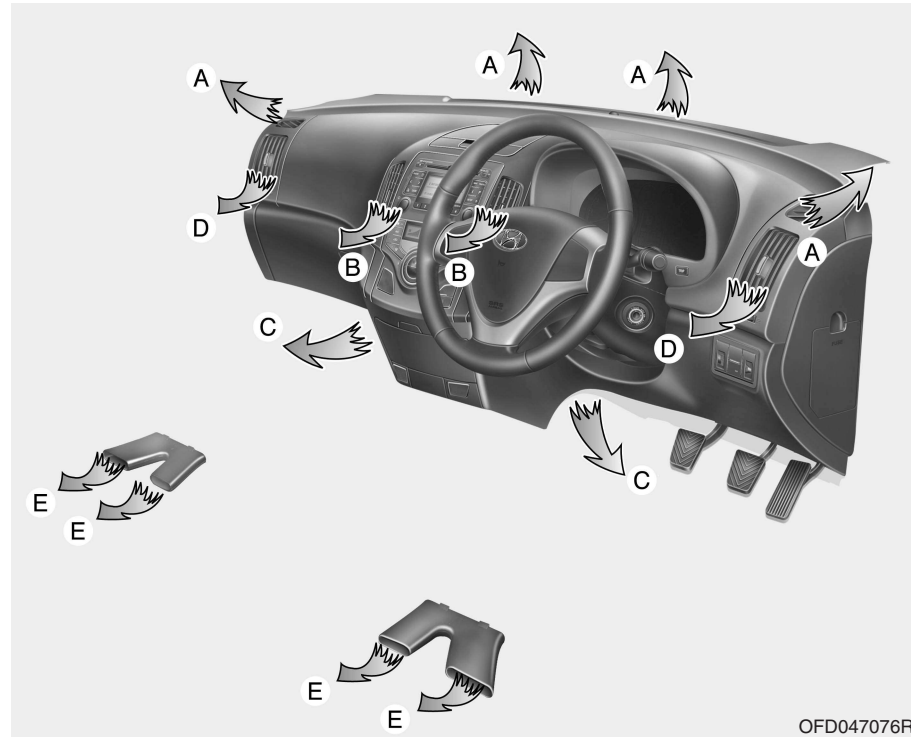

OFD047076R

Features of your vehicle

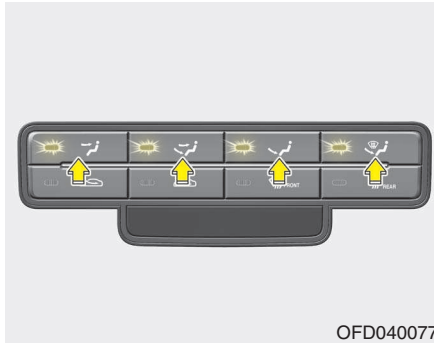

D230101AFD

Mode selection

The mode buttons control the direction of the air flow through the ventilation system.

Air can be directed to the floor, dashboard outlets, or windshield. Five symbols are used to represent Face, Bi-Level, Floor, Floor-Defrost and Defrost air position.

Face-Level (B,D)

Air flow is directed toward the upper body and face. Additionally, each outlet can be controlled to direct the air discharged from the outlet.

Bi-Level (B, D, C, E)

Air flow is discharged towards the face and floor.

Floor-Level (C, E, A, D)

Most of the air flow is directed to the floor, with a small amount of the air being directed to the windshield and side window defroster.

Floor/Defrost-Level (A, C, E, D)

Most of the air flow is directed to the floor and the windshield with a small amount directed to the side window defrosters.

Defrost-Level (A, D)

Most of the air flow is directed to the windshield with a small amount of air directed to the side window defrosters.

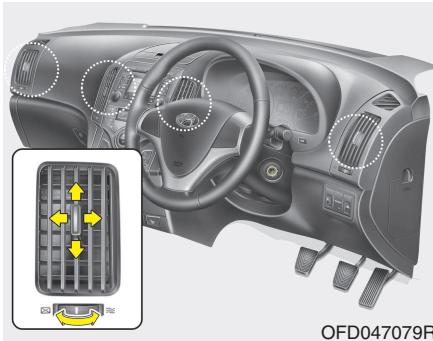

OFD047079R

Instrument panel vents

The outlet port can be opened or closed separately using the horizontal thumbwheel. To close the vent, rotate it left to the maximum position. To open the vent, rotate it right to the desired position. Also, you can adjust the direction of air delivery from these vents using the vent control lever as shown.

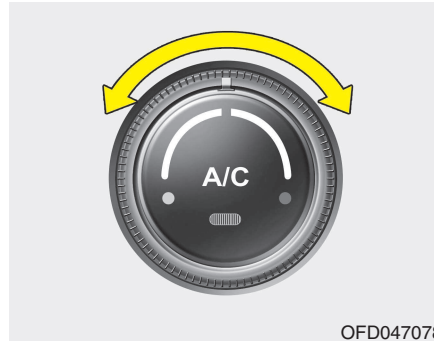

OFD047078

D230102AFD

Temperature control

The temperature control knob allows you to control the temperature of the air flowing from the ventilation system. To change the air temperature in the passenger compartment, turn the knob to the right position for warm air or left position for cooler air.

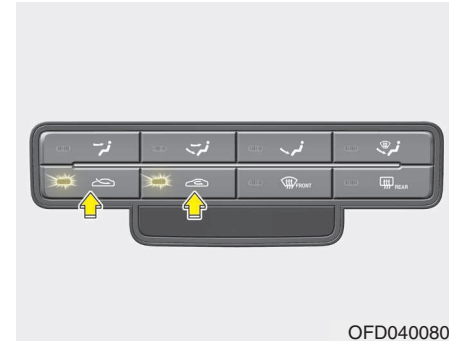

OFD040080

D230103AFD

Air intake control

This is used to select outside (fresh) air position or recirculated air position. To change the air intake control position, push the control button.

Recirculated air position



The indicator light on the button is illuminated when the recirculated air position is selected.

With the recirculated air position selected, air from passenger compartment will be drawn through the heating system and heated or cooled according to the function selected.

Outside (fresh) air position



The indicator light on the button is illuminated when the outside (fresh) air position is selected.

With the outside (fresh) air position selected, air enters the vehicle from outside and is heated or cooled according to the function selected.

* NOTICE

Prolonged operation of the heater in the recirculated air position (without air conditioning selected) may cause fogging of the windshield and side windows and the air within the passenger compartment may become stale.

In addition, prolonged use of the air conditioning with the recirculated air position selected will result in excessively dry air in the passenger compartment.

WARNING

- Continued use of the climate control system operation in the recirculated air position may allow humidity to increase inside the vehicle which may fog the glass and obscure visibility.
- Do not sleep in a vehicle with the air conditioning or heating system on. It may cause serious harm or death due to a drop in the oxygen level and/or body temperature.
- Continued use of the climate control system operation in the recirculated air position can cause drowsiness or sleepiness, and loss of vehicle control. Set the air intake control to the outside (fresh) air position as much as possible while driving.



OFD047081

D230104AUN

Fan speed control

The ignition switch must be in the ON position for fan operation.

The fan speed control knob allows you to control the fan speed of the air flowing from the ventilation system. To change the fan speed, turn the knob to the right for higher speed or left for lower speed.

Setting the fan speed control knob to the "0" position turns off the fan.

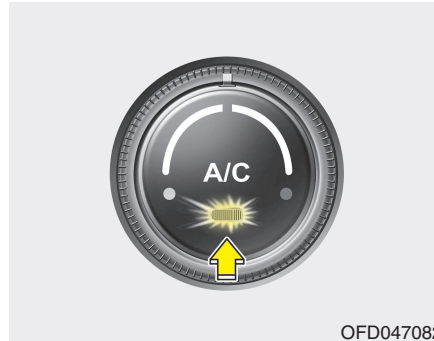

OFD047082

D230105AUN

Air conditioning (if equipped)

Push the A/C button to turn the air conditioning system on (indicator light will illuminate). Push the button again to turn the air conditioning system off.

System operation

D230501AUN

Ventilation

1. Set the mode to the position.
2. Set the air intake control to the outside (fresh) air position.
3. Set the temperature control to the desired position.
4. Set the fan speed control to the desired speed.

D230502AUN

Heating

1. Set the mode to the position.
2. Set the air intake control to the outside (fresh) air position.
3. Set the temperature control to the desired position.
4. Set the fan speed control to the desired speed.
5. If dehumidified heating is desired, turn the air conditioning system (if equipped) on.
 - If the windshield fogs up, set the mode to the , position.

Operation Tips

- To keep dust or unpleasant fumes from entering the car through the ventilation system, temporarily set the air intake control to the recirculated air position. Be sure to return the control to the fresh air position when the irritation has passed to keep fresh air in the vehicle. This will help keep the driver alert and comfortable.
- Air for the heating/cooling system is drawn in through the grilles just ahead of the windshield. Care should be taken that these are not blocked by leaves, snow, ice or other obstructions.
- To prevent interior fog on the windshield, set the air intake control to the fresh air position and fan speed to the desired position, turn on the air conditioning system, and adjust temperature control to desired temperature.

D230503AFD

Air conditioning (if equipped)

All HYUNDAI Air Conditioning Systems are filled with environmentally friendly R-134a refrigerant which does not damage to the ozone layer.

1. Start the engine. Push the air conditioning button.
 2. Set the mode to the  position.
 3. Set the air intake control to the outside air or recirculated air position.
 4. Adjust the fan speed control and temperature control to maintain maximum comfort.
- When maximum cooling is desired, set the temperature control to the extreme left position then set the fan speed control to the highest speed.

*** NOTICE**

- When using the air conditioning system, monitor the temperature gauge closely while driving up hills or in heavy traffic when outside temperatures are high. Air conditioning system operation may cause engine overheating. Continue to use the blower fan but turn the air conditioning system off if the temperature gauge indicates engine overheating.
- When opening the windows in humid weather air conditioning may create water droplets inside the vehicle. Since excessive water droplets may cause damage to electrical equipment, air conditioning should only be run with the windows closed.

Air conditioning system operation tips

- If the vehicle has been parked in direct sunlight during hot weather, open the windows for a short time to let the hot air inside the vehicle escape.
- To help reduce moisture inside of windows on rainy or humid days, decrease the humidity inside the vehicle by operating the air conditioning system.
- During air conditioning system operation, you may occasionally notice a slight change in engine speed as the air conditioning compressor cycles. This is a normal system operation characteristic.
- Use the air conditioning system every month if only for a few minutes to ensure maximum system performance.
- When using the air conditioning system, you may notice clear water dripping (or even puddling) on the ground under the passenger side of the vehicle. This is a normal system operation characteristic.
- Operating the air conditioning system in the recirculated air position provides maximum cooling, however, continual operation in this mode may cause the air inside the vehicle to become stale.
- During cooling operation, you may occasionally notice a misty air flow because of rapid cooling and humid air intake. This is a normal system operation characteristic.

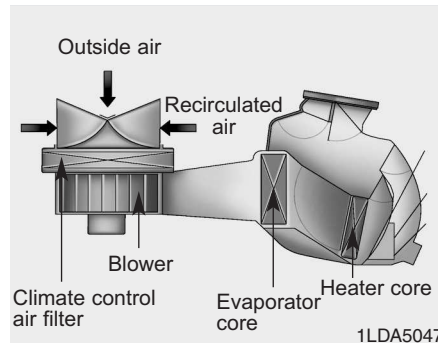

D230300AFD-EA

Climate control air filter (if equipped)

The climate control air filter installed behind the glove box filters the dust or other pollutants that come into the vehicle from the outside through the heating and air conditioning system. If dust or other pollutants accumulate in the filter over a period of time, the air flow from the air vents may decrease, resulting in moisture accumulation on the inside of the windshield even when the outside (fresh) air position is selected. If this happens, have the climate control air filter replaced by an authorised HYUNDAI dealer.

* NOTICE

- Replace the filter according to the Maintenance Schedule. If the car is being driven in severe conditions such as dusty, rough roads, more frequent climate control air filter inspections and changes are required.
- When the air flow rate is suddenly decreased, the system should be checked at an authorised HYUNDAI dealer.

D230400AFD-EA

Checking the amount of air conditioner refrigerant and compressor lubricant

When the amount of refrigerant is low, the performance of the air conditioning is reduced. Overfilling also has a bad influence on the air conditioning system.

Therefore, if abnormal operation is found, have the system inspected by an authorised HYUNDAI dealer.

*** NOTICE**

It is important when servicing the air conditioning system that the correct type and amount of oil and refrigerant is used. Otherwise, damage to the compressor and abnormal system operation may occur.

WARNING

The air conditioning system should be serviced by an authorised HYUNDAI dealer. Improper service may cause serious injury to the person performing the service.

AUTOMATIC CLIMATE CONTROL SYSTEM (IF EQUIPPED)

Type A



- 1. Fan speed control button
- 2. Air conditioning button
- 3. Air intake control button
- 4. Front windshield defrost button

- 5. AUTO (automatic control) button
- 6. OFF button
- 7. Temperature control knob
- 8. Rear window defrost button

- 9. Mode selection button
- 10. A/C display

OFD0471100

D240000AFD

Features of your vehicle

Type B

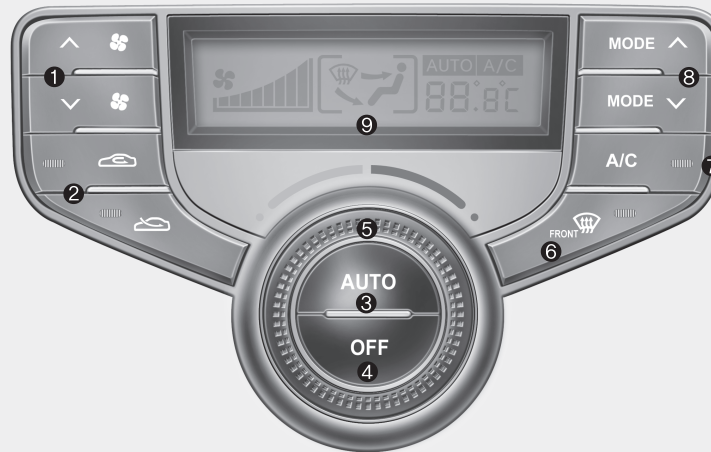

1. Fan speed control button
2. Air intake control button
3. AUTO (automatic control) button

4. OFF button
5. Temperature control knob
6. Front windshield defrost button

7. Air conditioning button
8. Mode selection button
9. A/C display

OFD0471101

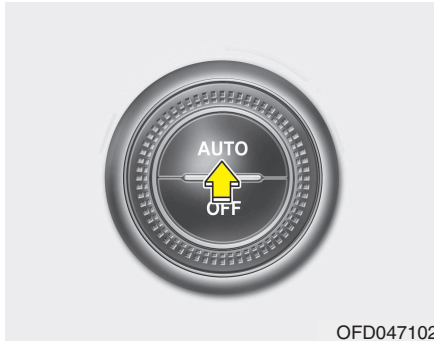

OFD047102

D240100AFD

Automatic heating and air conditioning

The automatic climate control system is controlled by simply setting the desired temperature.

The Full Automatic Temperature Control (FATC) system automatically controls the heating and cooling system as follows;

1. Push the AUTO button. It is indicated by AUTO on the display. The modes, fan speeds, air intake and air-conditioning will be controlled automatically by temperature setting.

2. Turn the temperature control knob to set the desired temperature.

If the temperature is set to the lowest setting (Lo), the air conditioning system will operate continuously.

3. To turn the automatic operation off, press any button except temperature control knob. If you press the mode selection button, air-conditioning button*, defrost button, air intake control button* or fan speed button, the selected function will be controlled manually while other functions operate automatically. (* : type B only)

Regardless of the temperature setting, when using automatic operation, the air conditioning system can automatically turn on to decrease the humidity inside the vehicle, even if the temperature is set to warm.

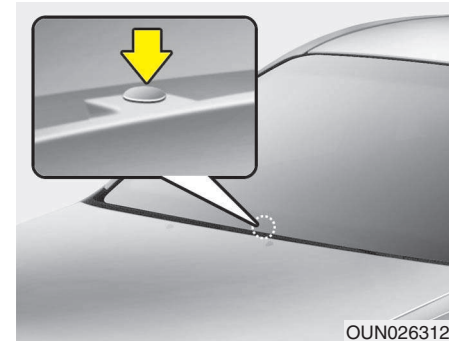

OUN026312

* NOTICE

Never place anything over the sensor located on the instrument panel to ensure better control of the heating and cooling system.

D240200AUN

Manual heating and air conditioning

The heating and cooling system can be controlled manually by pushing buttons other than the AUTO button. In this case, the system works sequentially according to the order of buttons selected.

When pressing any button (or turning any knob) except AUTO button while automatic operation, the functions not selected will be controlled automatically.

1. Start the engine.
2. Set the mode to the desired position.
3. Set the temperature control to the desired position.
4. Set the air intake control to the outside (fresh) air position.
5. Set the fan speed control to the desired speed.
6. If air conditioning is desired, turn the air conditioning system on.

Press the AUTO button in order to convert to full automatic control of the system.

Type A

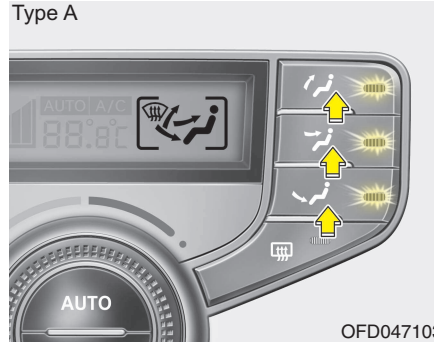

OFD047103

D240201AFD

Mode selection

The mode selection button controls the direction of the air flow through the ventilation system.

Refer to the illustration in the “Manual climate control system”.

Type A :

If you push the button once, the corresponding switch will turn on, and if you push the button again, the switch will turn off.



Face-Level (B, D)

Air flow is directed toward the upper body and face. Additionally, each outlet can be controlled to direct the air discharged from the outlet.



Floor-Level (C, E, A, D)

Most of the air flow is directed to the floor.



Defrost-Level (A, D)

Most of the air flow is directed to the windshield.

Also you may select 2~3 modes at the same time for desired air flow.

- face (٠) + floor (٠) mode
- face (٠) + defrost (٠) mode
- floor (٠) + defrost (٠) mode
- face (٠) + floor (٠) + defrost (٠) mode

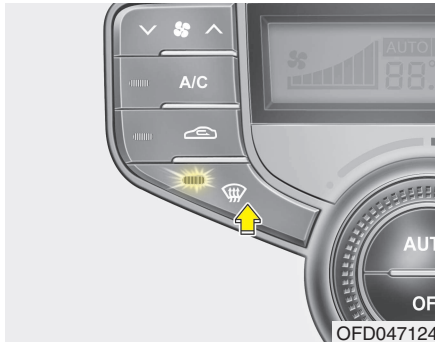

OFD047124

Maximum (MAX) defrost mode

When you select the MAX defrost mode, the following system settings will be made automatically;

- the air conditioning system will be turned on.
- the outside(fresh) air position will be selected.
- the fan speed will be set to the high speed.

To turn the MAX defrost mode off, press the mode button (, ,) or MAX () defrost button again or AUTO button.

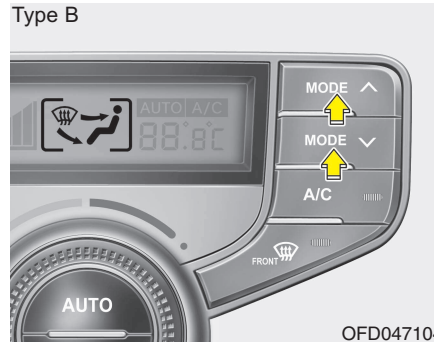

Type B

OFD047104

Type B:

The air flow outlet port is converted as follows:



Face-Level (B, D)

Air flow is directed toward the upper body and face. Additionally, each outlet can be controlled to direct the air discharged from the outlet.

Bi-Level (B, D, C, E)

Air flow is discharged towards the face and floor.

Floor-Level (C, E, A, D)

Most of the air flow is directed to the floor, with a small amount of the air being directed to the windshield and side window defroster.

Floor/Defrost-Level (A, C, E, D)

Most of the air flow is directed to the floor and the windshield with a small amount directed to the side window defrosters.

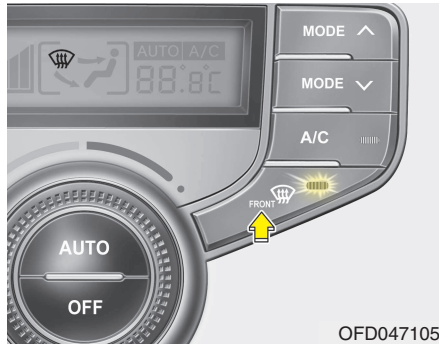

Defrost-level (A, D)

Most of the air flow is directed to the windshield with a small amount of air directed to the side window defrosters.

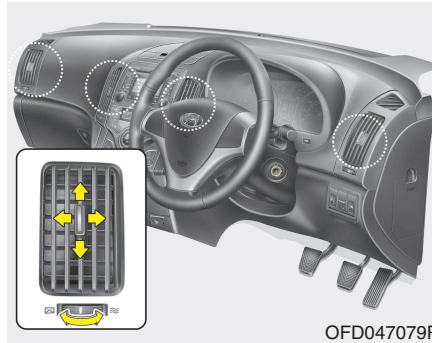

Instrument panel vents

The outlet port can be opened or closed separately using the horizontal thumb-wheel. To close the vent, rotate it left to the maximum position. To open the vent, rotate it right to the desired position. Also, you can adjust the direction of air delivered from these vents using the vent control lever as shown.

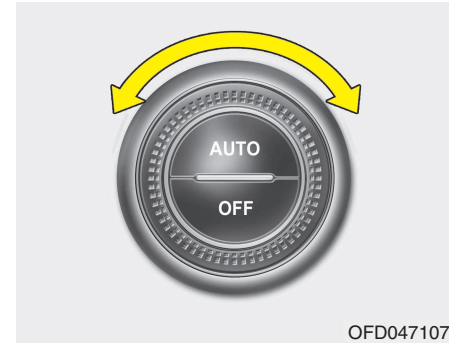

D240202AUN

Temperature control

The temperature will increase to the maximum (HI) by turning the knob to the right extremely.

The temperature will decrease to the minimum (Lo) by turning the knob to the left extremely.

When turning the knob, the temperature will increase or decrease by 0.5°C/1°F. When set to the lowest temperature setting, the air conditioning will operate continuously.

Temperature conversion

If the battery has been discharged or disconnected, the temperature mode display will reset to Centigrade.

This is normal condition. You can switch the temperature mode between Centigrade to Fahrenheit as follows;

While depressing the AUTO button, depress the OFF button for 3 seconds or more. The display will change from Centigrade to Fahrenheit, or from Fahrenheit to Centigrade.

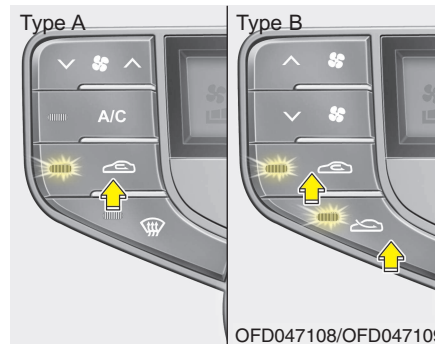

D240203AFD

Air intake control

This is used to select outside (fresh) air position or recirculated air position.

To change the air intake control position, push the control button.

Recirculated air position

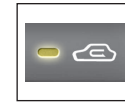

The indicator light on the button illuminates when the recirculated air position is selected.

With the recirculated air position selected, air from passenger compartment will be drawn through the heating system and heated or cooled according to the function selected.

Outside (fresh) air position



The indicator light on the button does not illuminate when the outside (fresh) air position is selected (type A).



With the outside (fresh) air position selected, air enters the vehicle from outside and is heated or cooled according to the function selected.

* NOTICE

It should be noted that prolonged operation of the heating in recirculated air position will cause fogging of the windshield and side windows and the air within the passenger compartment will become stale.

In addition, prolonged use of the air conditioning with the recirculated air position selected, will result in excessively dry air in the passenger compartment.

WARNING

- Continued use of the climate control system operation in the recirculated air position may allow humidity to increase inside vehicle which may fog the glass and obscure visibility.
- Do not sleep in a vehicle with air conditioning or heating system on. It may cause serious harm or death due to a drop in the oxygen level and/or body temperature.
- Continued use of the climate control system operation in the recirculated air position can cause drowsiness or sleepiness, and loss of vehicle control. Set the air intake control to the outside (fresh) air position as much as possible while driving.

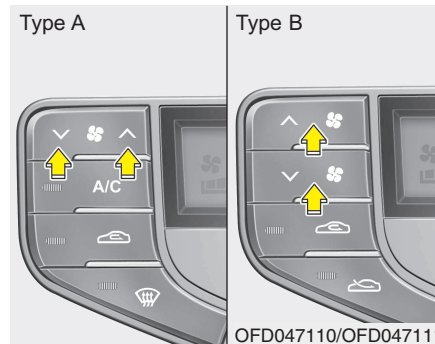

D240205AUN

Fan speed control

The fan speed can be set to the desired speed by pressing the fan speed control button.

The higher the fan speed is, the more air is delivered.

Pressing the OFF button turns off the fan.

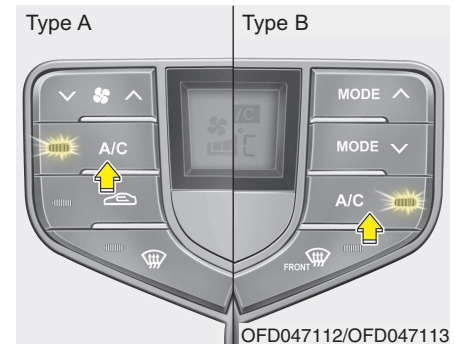

D240206AUN

Air conditioning

Push the A/C button to turn the air conditioning system on (indicator light will illuminate).

Push the button again to turn the air conditioning system off.

WINDSHIELD DEFROSTING AND DEFOGGING

D250000AUN-EA

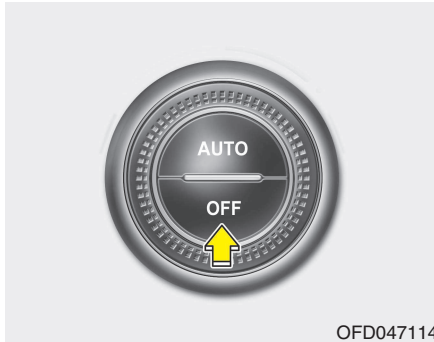

OFD047114

D240208AUN

OFF mode

Push the OFF button to turn off the air climate control system. However you can still operate the mode and air intake buttons as long as the ignition switch is in the position ON.

⚠ WARNING - Windshield heating

Do not use the or position during cooling operation in extremely humid weather. The difference between the temperature of the outside air and that of the windshield could cause the outer surface of the windshield to fog up, causing loss of visibility. In this case, set the mode selection knob or button to the position and fan speed control knob or button to a lower speed.

- For maximum defrosting, set the temperature control to the extreme right/hot position and the fan speed control to the highest speed.
- If warm air to the floor is desired while defrosting or defogging, set the mode to the floor-defrost position.
- Before driving, clear all snow and ice from the windshield, rear window, outside rear view mirrors, and all side windows.
- Clear all snow and ice from the bonnet and air inlet in the cowl grill to improve heater and defroster efficiency and to reduce the probability of fogging up inside of the windshield.

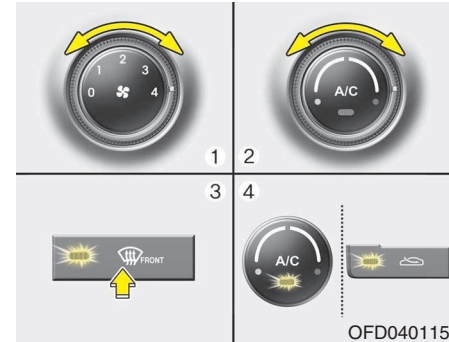

OFD040115

Manual climate control system

D250101AFD

To defog inside windshield

1. Select any fan speed except "0" position.
2. Select desired temperature.
3. Select the or position.
4. The outside (fresh) air and air conditioning will be selected automatically.

If the air-conditioning and outside (fresh) air position are not selected automatically, press the corresponding button manually.

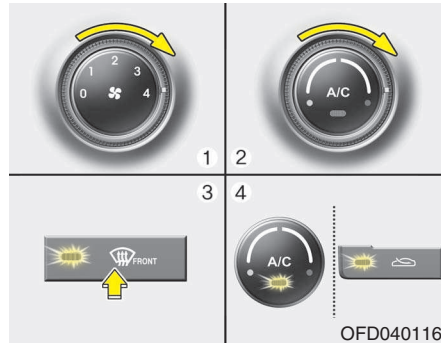

D250102AFD

To defrost outside windshield

1. Set the fan speed to the highest (extreme right) position.
2. Set the temperature to the extreme hot position.
3. Select the  position.
4. The outside (fresh) air and air conditioning will be selected automatically.

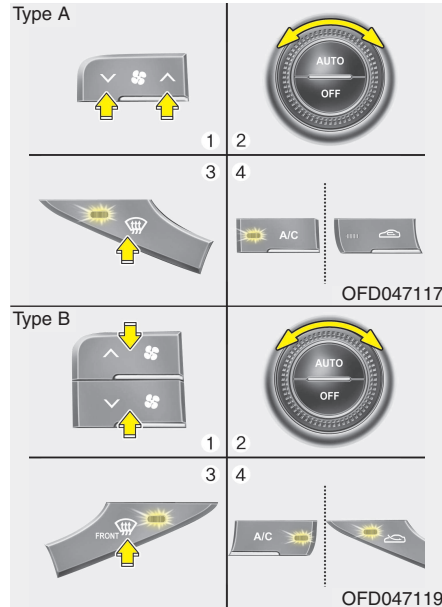

Automatic climate control system

D250201AFD

To defog inside windshield

1. Select desired fan speed.
2. Select desired temperature.
3. Press the defrost button ().

4. The air-conditioning will be turned on according to the detected ambient temperature, outside (fresh) air position and higher fan speed will be selected automatically.

If the air-conditioning, outside (fresh) air position and higher fan speed are not selected automatically, adjust the corresponding button or knob manually.

If the  position is selected, lower fan speed is controlled to higher fan speed.

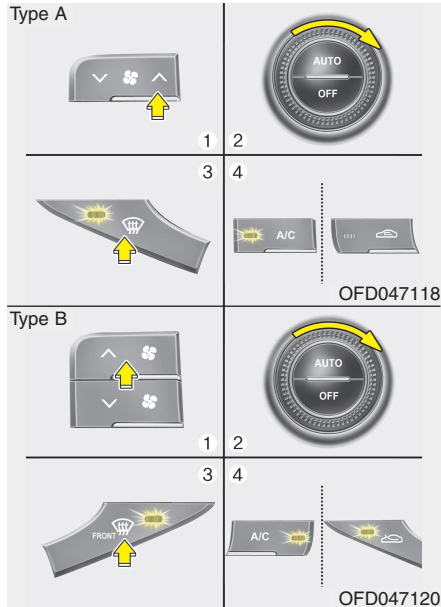

D250202AFD

To defrost outside windshield

1. Set fan speed to the highest position.
2. Set temperature to the extreme hot (HI) position.
3. Press the defrost button ().

4. The air-conditioning will be turned on according to the detected ambient temperature and outside (fresh) air position will be selected automatically. If the position is selected, lower fan speed is controlled to higher fan speed.

D250300AUN

Defogging logic

To reduce the possibility of fogging up the inside of the windshield, the air intake or air conditioning are controlled automatically according to certain conditions such as or position. To cancel or return the defogging logic, do the followings.

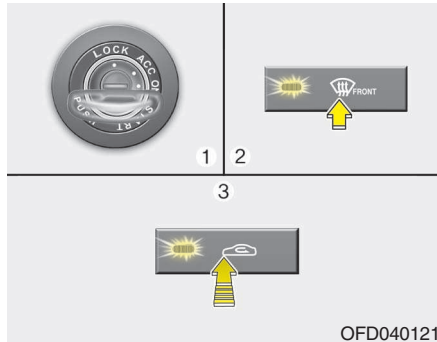

D250301AFD

Manual climate control system

1. Turn the ignition switch to the ON position.
2. Turn the mode selection knob to the defrost position (☀️).
3. Push the air intake control button (🚗) at least 5 times within 3 seconds.

The indicator light in the air intake control button will blink 3 times with 0.5 second of interval. It indicates that the defogging logic is canceled or returned to the programmed status.

If the battery has been discharged or disconnected, it is reset to the defog logic status.

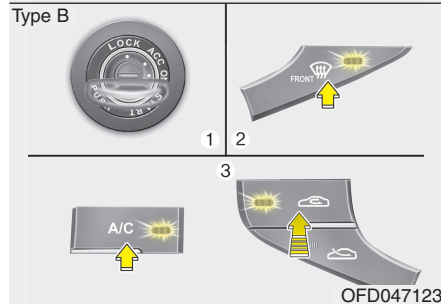
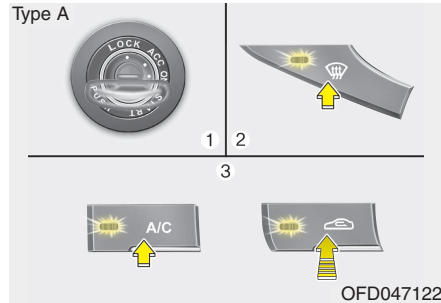

D250302AUN

Automatic climate control system

1. Turn the ignition switch to the ON position.
2. Select the defrost position pressing defrost button (☀️).
3. While holding the air conditioning button (A/C) pressed, press the air intake control button (🚗) at least 5 times within 3 seconds.

The A/C display blinks 3 times with 0.5 second of interval. It indicates that the defogging logic is canceled or returned to the programmed status.

If the battery has been discharged or disconnected, it is reset to the defog logic status.

STORAGE COMPARTMENT

D270000AUN

These compartments can be used to store small items required by the driver or passengers.

CAUTION

- *To avoid possible theft, do not leave valuables in the storage compartment.*
- *Always keep the storage compartment covers closed while driving. Do not attempt to place so many items in the storage compartment that the storage compartment cover can not close securely.*

WARNING - Flammable materials

Do not store cigarette lighters, propane cylinders, or other flammable/explosive materials in the vehicle. These items may catch fire and/or explode if the vehicle is exposed to hot temperatures for extended periods.

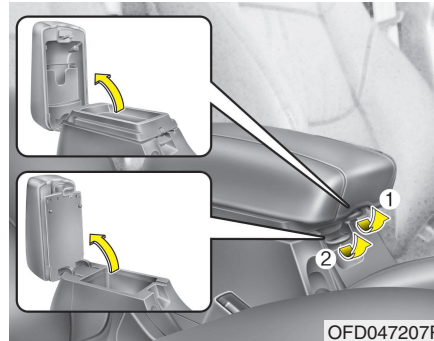

D270100AFD-EA

Centre console storage (if equipped)

These compartments can be used to store small items required by the driver or front passenger.

To open the centre console storage, pull up the lever.

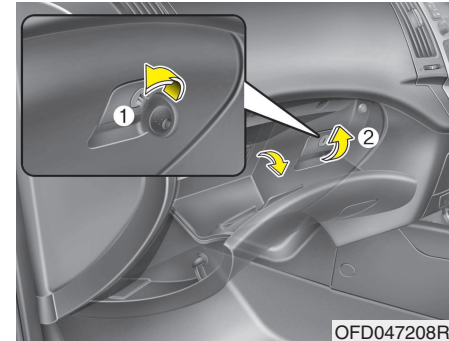

D270200AFD

Glove box

The glove box can be locked and unlocked with a master key.

To open the glove box, pull the handle and the glove box will automatically open. Close the glove box after use.

WARNING

To reduce the risk of injury in an accident or sudden stop, always keep the glove box door closed while driving.

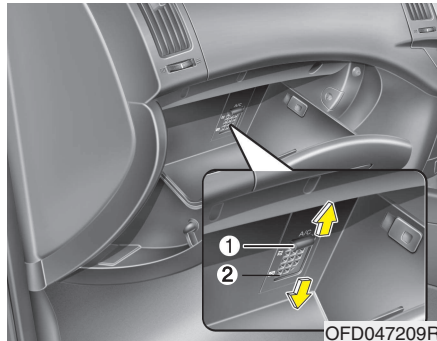

Glove box cooling (if equipped)

You can keep beverage cans or other items warm or cool using the open/close lever of the vent installed in the glove box.

1. Turn on the fan control switch.
2. Set the air flow control to the face () mode.
3. Turn the open/close lever of the vent installed in the glove box to the open position.
 - (1) OPEN
 - (2) CLOSE

4. Set the temperature control to warm or cool.

When the cool box is not used, turn the lever to its closed position.

*** NOTICE**

While using the cooling function, a small amount of condensed moisture could damage your pieces of paper.

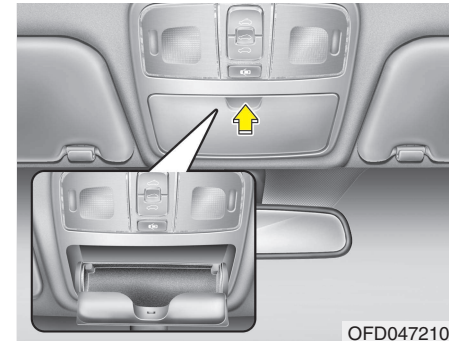

D270300AUN

Sunglass holder

To open the sunglass holder, press the cover and the holder will slowly open. Place your sunglasses in the compartment door with the lenses facing out. Push to close.

⚠ WARNING

- Do not keep objects except sunglasses inside the sunglass holder. Such objects can be thrown from the holder in the event of a sudden stop or an accident, possibly injuring the passengers in the vehicle.
- Do not open the sunglass holder while the vehicle is moving. The rear view mirror of the vehicle can be blocked by an open sunglass holder.

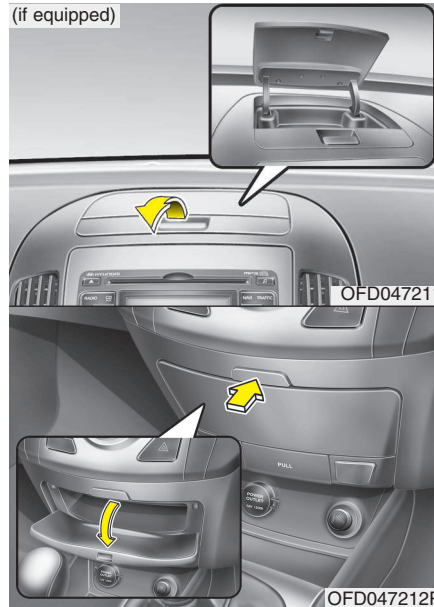

D270400AFD

Multi box

To open the cover, pull the lever or push the button. It can be used for storing small items.

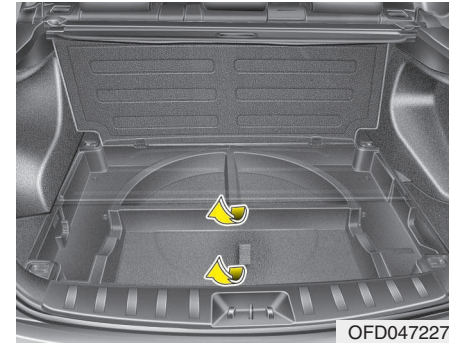

D270500AFD

Luggage box (if equipped)

You can place a first aid kit, a reflector triangle, tools, etc. in the box for easy access.

1. Grasp the handle on the top of the cover and lift it.

Features of your vehicle



D270501AFD

Luggage side tray

To open the cover, pull up the handle and lift the cover (if equipped). It can be used for storing small items.

INTERIOR FEATURES

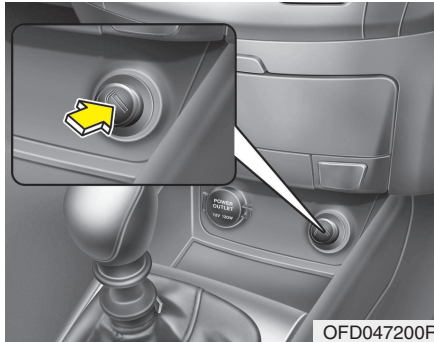

OFD047200R

D280100AFD

Cigarette lighter

For the cigarette lighter to work, the ignition switch must be in the ACC position or the ON position.

To use the cigarette lighter, push it all the way into its socket. When the element has heated, the lighter will pop out to the "ready" position.

Do not hold the cigarette lighter pressed in. This can damage the heating element and create a fire hazard.

If it is necessary to replace the cigarette lighter, use only a genuine HYUNDAI replacement or its approved equivalent.

⚠ WARNING

- Do not hold the lighter in after it is already heated because it will overheat.
- If the lighter does not pop out within 30 seconds, remove it to prevent overheating.

⚠ CAUTION

Only a genuine HYUNDAI lighter should be used in the cigarette lighter socket. The use of plug-in accessories (shavers, hand-held vacuums, and coffee pots, for example) may damage the socket or cause electrical failure.

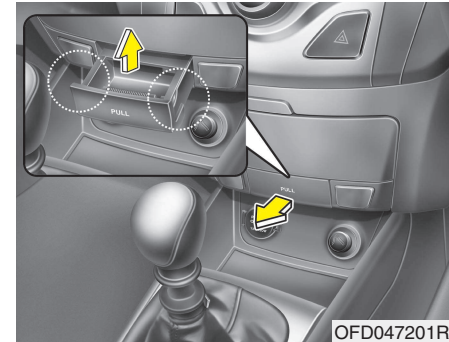

OFD047201R

D280200AFD

Ashtray

⚠ WARNING - Ashtray use

- Do not use the vehicle's ashtrays as waste receptacles.
- Putting lit cigarettes or matches in an ashtray with other combustible materials may cause a fire.

The front ashtray may be opened by pulling the ashtray lid. To clean the ashtray, the plastic receptacle should be removed by lifting the plastic ash receptacle upward and pulling it out.

D280300AUN

Cup holder

⚠ WARNING - Hot liquids

- Do not place uncovered cups of hot liquid in the cup holder while the vehicle is in motion. If the hot liquid spills, you burn yourself. Such a burn to the driver could lead to loss of control of the vehicle.
- To reduce the risk of personal injury in the event of sudden stop or collision, do not place uncovered or unsecured bottles, glasses, cans, etc., in the cup holder while the vehicle is in motion.

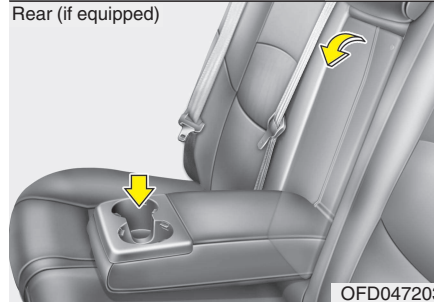
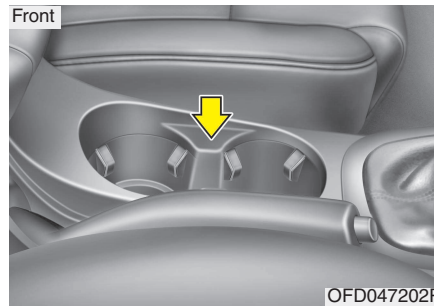

D280301AFD

Front

Cups or small beverage cans may be placed in the cup holders.

Rear (if equipped)

Cups may be placed in the cup holders.

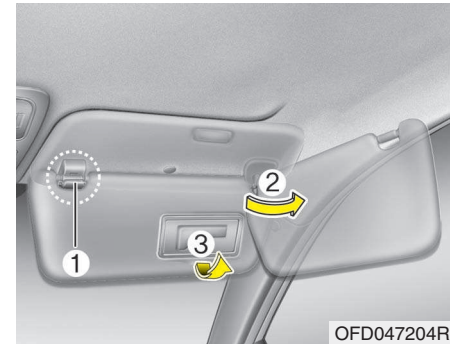

D280400AFD

Sunvisor

Use the sunvisor to shield direct light through the front or side windows.

To use a sunvisor, pull it downward.

To use a sunvisor for a side window, pull it downward, unsnap it from the bracket (1) and swing it to the side (2).

To use the vanity mirror, pull down the visor and pull up the mirror cover (3).

⚠ CAUTION - Vanity mirror lamp (if equipped)

Close the vanity mirror cover securely and return the sunvisor to its original position after use. If the vanity mirror is not closed securely, the lamp will stay on and could result in battery discharge.

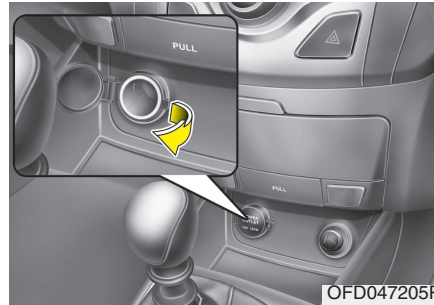

OFD047205R

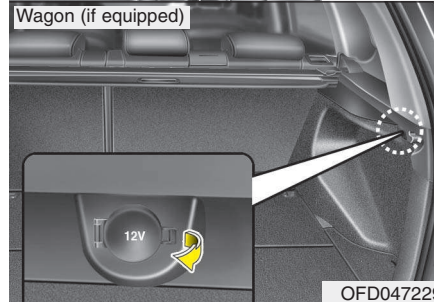

OFD047229

D280500AUN

Power outlet

The power outlet is designed to provide power for mobile telephones or other devices designed to operate with vehicle electrical systems. The devices should draw less than 10 amps with the engine running.

⚠ CAUTION

- *Use power outlet only when the engine is running and remove the accessory plug after use. Using the accessory plug for prolonged periods of time with the engine off could cause the battery to discharge.*
- *Only use 12V electric accessories which are less than 10A in electric capacity.*
- *Adjust the air-conditioner or heater to the lowest operating level when using the power outlet.*
- *Close the cover when not in use.*
- *Some electronic devices can cause electronic interference when plugged into a vehicle's power outlet. These devices may cause excessive audio static and malfunctions in other electronic systems or devices used in your vehicle.*



D280600AUN

Digital clock (if equipped)

⚠ WARNING

Do not adjust the clock while driving. You may lose your steering control and cause severe personal injury or accidents.

Whenever the battery terminals or related fuses are disconnected, you must reset the time.

When the ignition switch is in the ACC or ON position, the clock buttons operate as follows:

D280601AUN

• **HOUR:**

Pressing the “H” button (2) with your finger, a pencil or similar object will advance the time displayed by one hour.

D280602AUN

• **MINUTE:**

Pressing the “M” button (3) with your finger, a pencil or similar object will advance the time displayed by one minute.

D280603AUN

• **RESET:**

To clear away minutes, press the “R” button (1) with your finger, a pencil or similar object. Then the clock will be set precisely on the hour.

For example, if the “R” button is pressed while the time is between 9:01 and 9:29, the display will be reset to 9:00.

9:01 ~ 9:29 display changed to 9:00

9:30 ~ 9:59 display changed to 10:00

D280604AUN

• **Display conversion:**

To change the 12 hour format to the 24 hour format, press the “R” button (1) for more than 4 seconds.

For example, if the “R” button is pressed for more than 4 seconds while the time is 10:15 p.m., the display will be changed to 22:15.

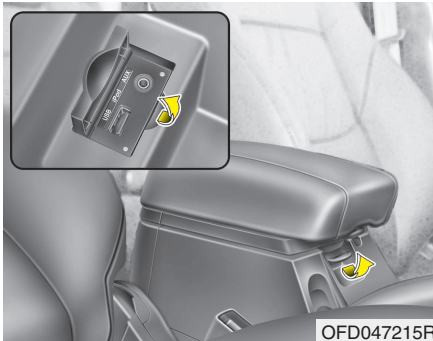

OFD047215R

D281400BFD

Aux, USB and iPod (if equipped)

If your vehicle has an aux and/or USB(universal serial bus) port or iPod port, you can use an aux port to connect audio devices and an USB port to plug in an USB and also an iPod port to plug in an iPod.

* NOTICE

When using a portable audio device connected to the power outlet, noise may occur during playback. If this happens, use the power source of the portable audio device.

* iPod is a trademark of Apple Inc.

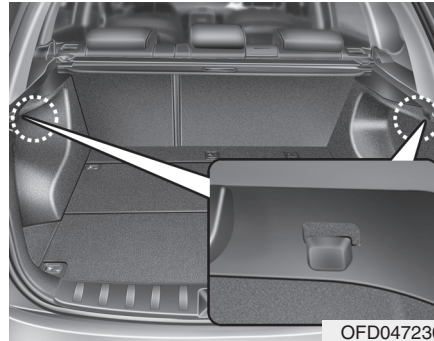

OFD047230

D280700AFD

Shopping bag holder (if equipped)

⚠ CAUTION

Do not hang a bag weighing more than 3 kg (7 lbs.). It may cause damage to the shopping bag holder.



OUN026348

D280800AUN

Clothes hanger

To use the hanger, pull down the upper portion of hanger.

⚠ CAUTION

Do not hang heavy clothes, since those may damage the hook.

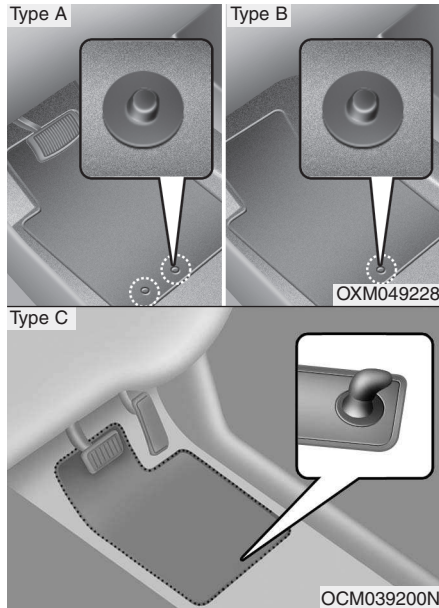

B571A03Y-AAT

Floor mat anchor(s) (if equipped)

When using a floor mat on the front floor carpet, make sure it attaches to the floor mat anchor(s) in your vehicle. This keeps the floor mat from sliding forward.

⚠ WARNING

The following must be observed when installing ANY floor mat to the vehicle.

- Ensure that the floor mats are securely attached to the vehicle's floor mat anchor(s) before driving the vehicle.
- Do not use ANY floor mat that cannot be firmly attached to the vehicle's floor mat anchors.
- Do not stack floor mats on top of one another (e.g. all-weather rubber mat on top of a carpeted floor mat). Only a single floor mat should be installed in each position.

IMPORTANT – Your vehicle was manufactured with driver's side floor mat anchors that are designed to securely hold the floor mat in place. To avoid any interference with pedal operation, **HYUNDAI** recommends that only the **HYUNDAI** floor mat designed for use in your vehicle be installed.

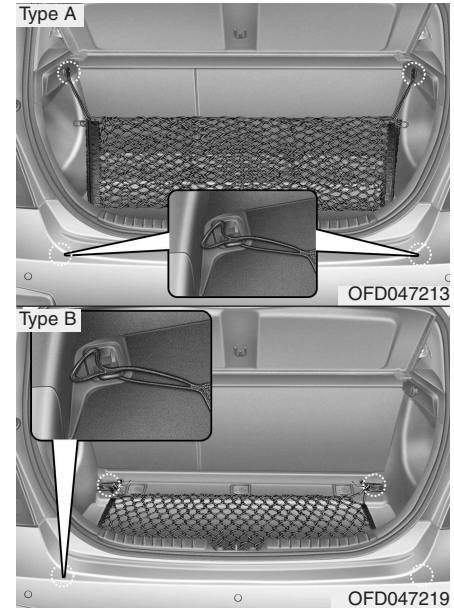

D281000AFD-EA

Luggage net (holder) (if equipped)

To keep items from shifting in the cargo area, you can use the four holders located in the cargo area to attach the luggage net.

If necessary, contact your authorised **HYUNDAI** dealer to obtain a luggage net.

For the full size spare tyre equipped vehicle : type A and type B available
 For the compact spare tyre equipped vehicle : type B available

CAUTION

To prevent damage to the goods or the vehicle, care should be taken when carrying fragile or bulky objects in the luggage compartment.

WARNING

Avoid eye injury. DO NOT overstretch the luggage net. ALWAYS keep your face and body out of the luggage net's recoil path. DO NOT use when the strap has visible signs of wear or damage.

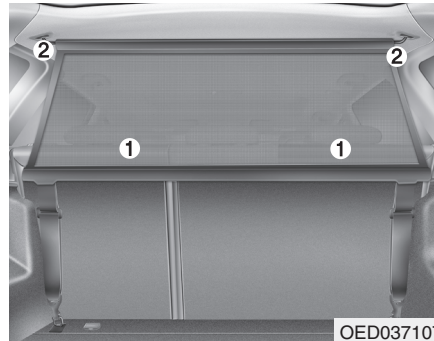

Barrier net (if equipped)

Your vehicle is equipped with a barrier net.

When you load some cargoes on the rear seat or rear cargo area, you must install the barrier net behind front seatback or rear seatback.

It is designed to help protect the heads of the occupants by obstructing objects flying forward in frontal collisions.

There are eight hook holders on both side of the headliner over the headrests for upper side fixation and on the floor behind the front seats or rear seats for lower side fixation.

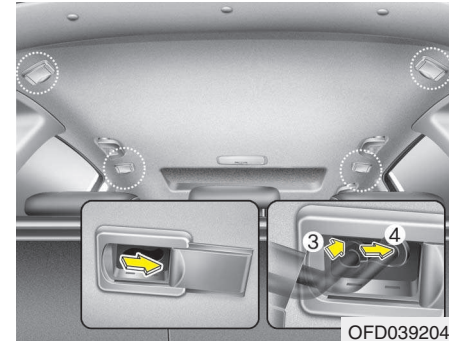

To install the barrier net

1. Open the cover for the holder position (1) or (2) you want to install.
2. Insert the net upper shaft into the large hole (3) and then secure by sliding into the small hole (4).

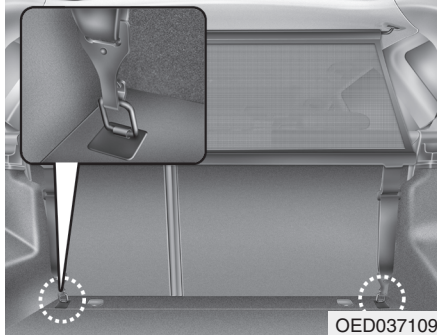
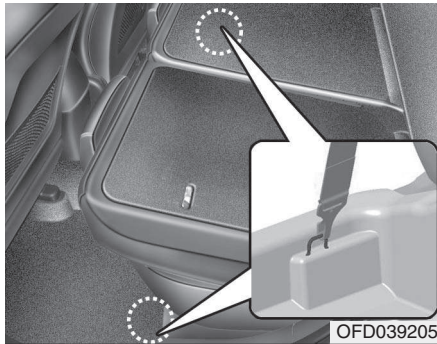

3. Hang the net strap hooks in the corresponding hook holders on the floor behind the front seat or rear seat.

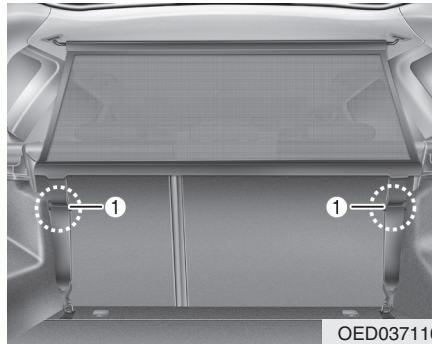

4. Fasten the straps, by using the adjuster (1).

⚠ WARNING

- Make sure that there is no slack in the barrier net by fastening the strap securely when installing the net. The strap should be fastened after confirming that the hook is inserted into the upper hook holder securely.
- Make sure that the seatbacks are locked securely.

⚠ WARNING

- Do not put passengers in the rear seat or cargo area behind the barrier net.
- Do not put passenger in the rear centre seat when the barrier net is installed behind the rear seats. The barrier net may interfere with use of the rear centre safety belt.
- Do not load cargo in the area higher than the barrier net's upper end.
- Do not load heavy cargo in the area higher than the seatback to avoid accident even if the barrier net is installed.
- Do not load cargo which has sharp edge that can pass through the barrier net.
- Do not apply excessive force to the barrier net by hanging on to the net or by suspending heavy cargo and so on.

To remove the barrier net

1. Loosen the straps by using the strap adjusters and remove the strap hooks from the hook holders.
2. Remove the net upper shaft by pulling it through the large holes.
3. Remove the barrier net.

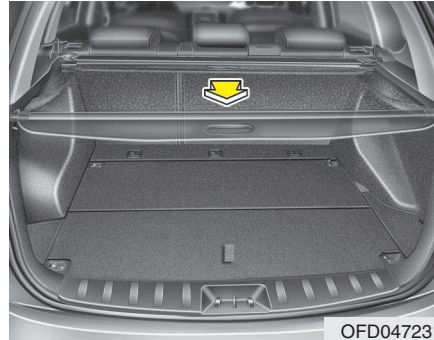

OFD047231

D281100AFD

Cargo security screen (if equipped)

Use the cargo security screen to hide items stored in the cargo area.

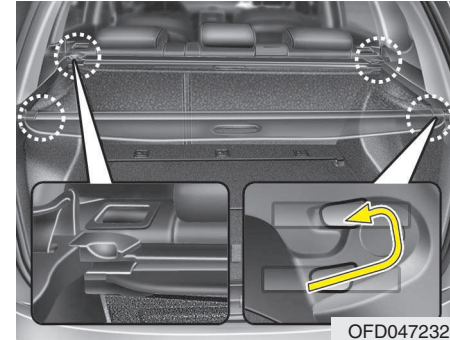

OFD047232

- To use the cargo security screen, pull the handle backward and insert the edges into the slots.

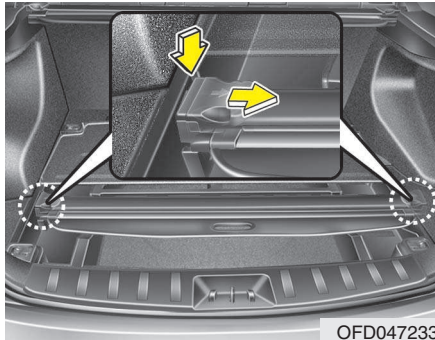

When not in use, place the cargo security screen on the lower portion of the cargo area.

⚠ WARNING

- Do not place objects on the cargo security screen. Such objects may be thrown about inside the vehicle and possibly injure vehicle occupants during an accident or when braking.
- Never allow anyone to ride in the luggage compartment. It is designed for luggage only.
- Maintain the balance of the vehicle and locate the weight as far forward as possible.

⚠ CAUTION

Since the cargo security screen may be damaged or malformed, do not put the luggage on it when it is used.

EXTERIOR FEATURES

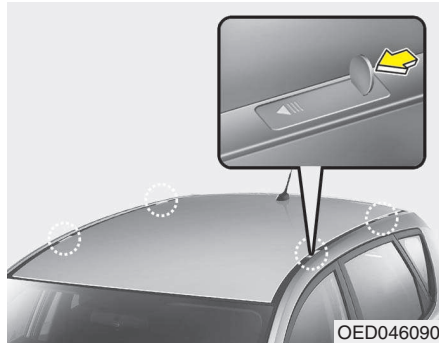

D290300AFD

Mounting bracket for roof carrier (if equipped)

To install or remove a roof carrier, you can use the mounting bracket and cover on the roof.

When you install a roof carrier, use the following procedure.

1. Insert a slim tool (coin or flat blade driver) into the slot and slide the cover toward the arrow on the cover.

⚠ WARNING

Use a coin or flat blade driver when you remove the roof carrier cover. If you use your fingernail, it may damage your fingernail.

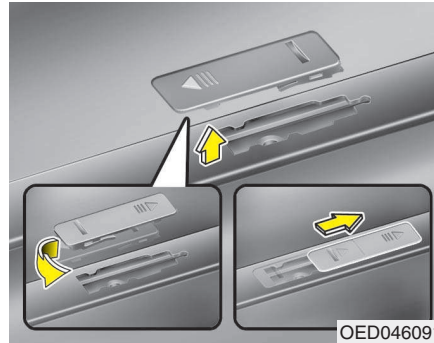

2. Rotate the cover half way and insert the cover on the roof hole as the illustration.

*** NOTICE**

To prevent losing the roof carrier cover, install the cover on the roof before you install the roof carrier.

3. After using the roof carrier, install the cover back on the roof in the reverse order.

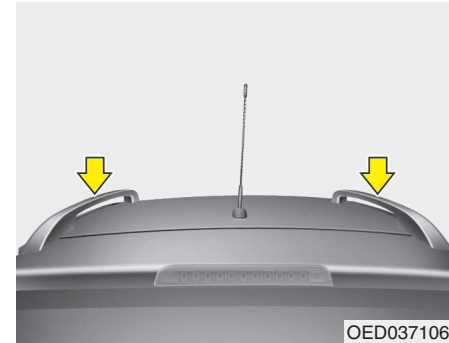

D290100AFD-EA

Roof rack (if equipped)

If the vehicle has a roof rack, you can load cargo on top of your vehicle.

* NOTICE

If the vehicle is equipped with a sunroof, be sure not to position cargo onto the roof rack in such a way that it could interfere with sunroof operation.

CAUTION

- *When carrying cargo on the roof rack, take the necessary precautions to make sure the cargo does not damage the roof of the vehicle.*
- *When carrying large objects on the roof rack, make sure they do not exceed the overall roof length or width.*

WARNING

- The following specification is the maximum weight that can be loaded onto the roof rack. Distribute the load as evenly as possible onto the roof rack and secure the load firmly.

ROOF RACK	75 kg (165 lbs.) EVENLY DISTRIBUTED
-----------	--

- Loading cargo or luggage in excess of the specified weight limit on the roof rack may damage your vehicle.
- The vehicle centre of gravity will be higher when items are loaded onto the roof rack. Avoid sudden starts, braking, sharp turns, abrupt manoeuvres or high speeds that may result in loss of vehicle control or rollover resulting in an accident.

(Continued)

(Continued)

- Always drive slowly and turn corners carefully when carrying items on the roof rack. Severe wind updrafts, caused by passing vehicles or natural causes, can cause sudden upward pressure on items loaded on the roof rack. This is especially true when carrying large, flat items such as wood panels or mattresses. This could cause the items to fall off the roof rack and cause damage to your vehicle or others around you.
- To prevent damage or loss of cargo while driving, check frequently before or while driving to make sure the items on the roof rack are securely fastened.

AUDIO SYSTEM

* NOTICE

If you install an aftermarket HID head lamp, your vehicle's audio and electronic device may malfunction.

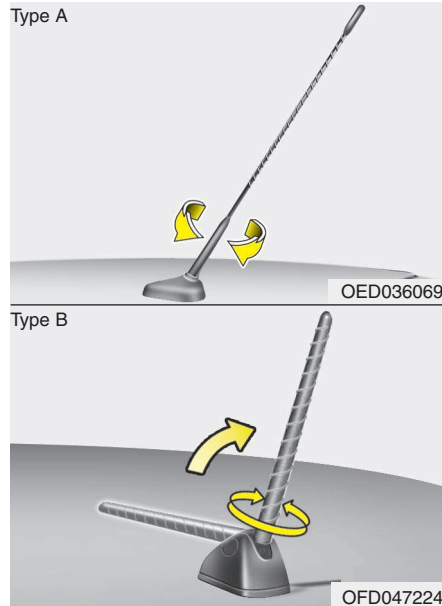

Antenna

D300102AFD-EA

Roof antenna

Your car uses a roof antenna to receive both AM and FM broadcast signals. This antenna is a removable type. To remove the antenna, turn it counterclockwise. To install the antenna, turn it clockwise.

CAUTION

- *Before entering a place with a low height clearance or a car wash, remove surely the antenna by rotating it counter-clockwise. If not, the antenna may be damaged.*
- *When reinstalling your antenna, it is important that it is fully tightened to ensure proper reception. The antenna may be removed when parking the vehicle or when loading cargo on the roof rack.*
- *When cargo is loaded on the roof rack, do not place the cargo near the antenna pole to ensure proper reception.*

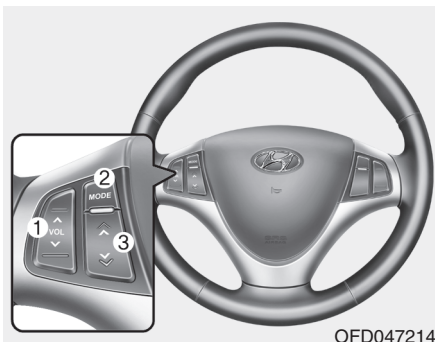

D300200AFD

Audio remote control (if equipped)

The steering wheel audio remote control button is installed to promote safe driving.

CAUTION

Do not operate audio remote control buttons simultaneously.

VOL (▲/▼) (1)

- Press the up button (▲) to increase volume.
- Press the down button (▼) to decrease volume.

MODE (2)

Press the button to select Radio, Tape (if equipped) or CD (compact disc).

SEEK (▲/▼) (3)

If the SEEK button is pressed for 0.8 second or more, it will work as follows in each mode.

RADIO mode

It will function as the AUTO SEEK select button.

CDP mode

It will function as the FF/REW button.

CDC mode

It will function as the DISC UP/DOWN button.

If the SEEK button is pressed for less than 0.8 second, it will work as follows in each mode.

RADIO mode

It will function as the PRESET STATION select buttons.

CDP mode

It will function as the TRACK UP/DOWN button.

CDC mode

It will function as the TRACK UP/DOWN button.

Detailed information for audio control buttons is described in the following pages in this section.

FM reception

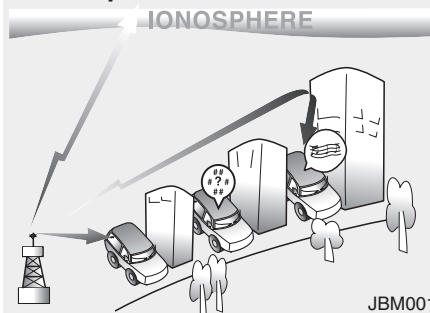

JBM001

D300800AFD-EA

How car audio works

AM and FM radio signals are broadcast from transmitter towers located around your city. They are intercepted by the radio antenna on your car. This signal is then received by the radio and sent to your car speakers.

When a strong radio signal has reached your vehicle, the precise engineering of your audio system ensures the best possible quality reproduction. However, in some cases the signal coming to your vehicle may not be strong and clear. This can be due to factors such as the distance from the radio station, closeness of other strong radio stations or the presence of buildings, bridges or other large obstructions in the area.

AM reception

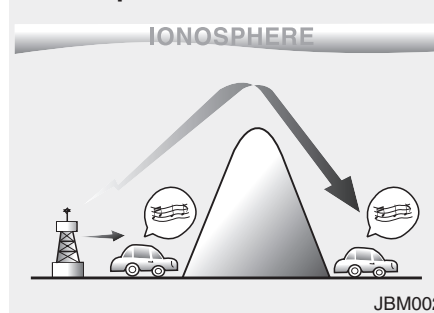

JBM002

AM broadcasts can be received at greater distances than FM broadcasts. This is because AM radio waves are transmitted at low frequencies. These long, low frequency radio waves can follow the curvature of the earth rather than travelling straight out into the atmosphere. In addition, they curve around obstructions so that they can provide better signal coverage.

FM radio station

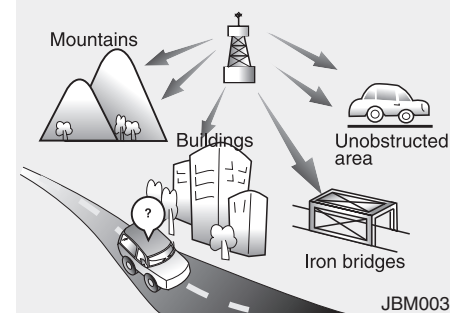

JBM003

FM broadcasts are transmitted at high frequencies and do not bend to follow the earth's surface. Because of this, FM broadcasts generally begin to fade at short distances from the station. Also, FM signals are easily affected by buildings, mountains, or other obstructions. These can result in certain listening conditions which might lead you to believe a problem exists with your radio. The following conditions are normal and do not indicate radio trouble:

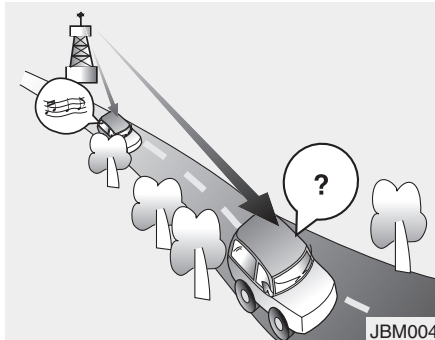

- **Fading** - As your car moves away from the radio station, the signal will weaken and sound will begin to fade. When this occurs, we suggest that you select another stronger station.
- **Flutter/Static** - Weak FM signals or large obstructions between the transmitter and your radio can disturb the signal causing static or fluttering noises to occur. Reducing the treble level may lessen this effect until the disturbance clears.

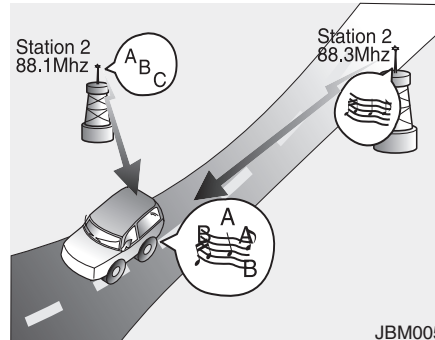

- **Station Swapping** - As a FM signal weakens, another more powerful signal near the same frequency may begin to play. This is because your radio is designed to lock onto the clearest signal. If this occurs, select another station with a stronger signal.
- **Multi-Path Cancellation** - Radio signals being received from several directions can cause distortion or fluttering. This can be caused by a direct and reflected signal from the same station, or by signals from two stations with close frequencies. If this occurs, select another station until the condition has passed.

Using a mobile phone or a two-way radio

When a mobile phone is used inside the vehicle, noise may be produced from the audio equipment. This does not mean that something is wrong with the audio equipment. In such a case, use the mobile phone at a place as far as possible from the audio equipment.

CAUTION

When using a communication system such a mobile phone or a radio set inside the vehicle, a separate external antenna must be fitted. When a mobile phone or a radio set is used with an internal antenna alone, it may interfere with the vehicle's electrical system and adversely affect safe operation of the vehicle.

WARNING

Don't use a mobile phone when you are driving. You must stop at a safe place to use a mobile phone.

Care of cassette tapes (if equipped)

- Because the thickness of a cassette tape with the total playback time of over 60 minutes (C-60) are too thin, we suggest that you do not use any of them to avoid having tapes being tangled.
- To achieve better sound quality, periodically clean the tape head using a cotton stick with colourless alcohol (once per month).
- If a tape is too loose, fasten it to reel by winding with objects like a pencil.
- Because dust or foreign objects on a cassette tape may damage the playback head, always store tapes in their cases when not in use.
- Make sure cassette tapes are kept away from magnetic devices (TV, stereo system, etc) in order to achieve better sound quality.
- Be certain that no objects or substances other than cassette tapes are inserted into the cassette tape player.
- Because tape media can be distorted when exposed to direct sunlight, do not leave cassette tapes on the seats, dashboard or near the back windshield.

Care of disc (if equipped)

- If the temperature inside the car is too high, open the car windows for ventilation before using your car audio.
- It is illegal to copy and use MP3/WMA/AAC/WAVE files without permission. Use CDs that are created only by lawful means.
- Do not apply volatile agents such as benzene and thinner, normal cleaners and magnetic sprays made for analogue disc onto CDs.
- To prevent the disc surface from getting damaged. Hold and carry CDs by the edges or the edges of the centre hole only.
- Clean the disc surface with a piece of soft cloth before playback (wipe it from the centre to the outside edge).
- Do not damage the disc surface or attach pieces of sticky tape or paper onto it.
- Make sure on undesirable matter other than CDs are inserted into the CD player (Do not insert more than one CD at a time).
- Keep CDs in their cases after use to protect them from scratches or dirt.

- Depending on the type of CD-R/CD-RW CDs, certain CDs may not operate normally according to manufacturing companies or making and recording methods. In such circumstances, if you still continue to use those CDs, they may cause the malfunction of your car audio system.

* NOTICE - Playing an Incompatible Copy-Protected Audio CD

Some copy protected CDs, which do not comply with the international audio CD standards (Red Book), may not play on your car audio. Please note that if you try to play copy protected CDs and the CD player does not perform correctly the CDs maybe defective, not the CD player.

RADIO, VOLUME CONTROL (SA710) (IF EQUIPPED)



A-100FD

1. FM/AM Selection Button

Turns to FM/AM mode and toggles FM1 and FM2→AM→FM1... when the button is pressed each time.

2. Power ON/OFF & Volume Control Button

Turns on/off the set when the IGNITION SWITCH is on ACC or ON. If the button is turned to the right, it increases the volume and left, decreases the volume.

3. AUTO STORE Button

When the button is pressed, it automatically selects and saves channels with high reception rate to PRESET buttons(1~6) and plays the channel saved in PRESET1.

If no channel is saved after AST, it will play the previous channel.

4. Automatic Channel Selection Button

- When the [SEEK √] button is pressed, it reduces the band frequency by 5kHz to automatically select channel. Stops at the previous frequency if no channel is found.
- When the [SEEK ^\] button is pressed, it increases the band frequency by 5kHz to automatically select channel. Stops at the previous frequency if no channel is found.

5. TUNE/AUDIO Control Button

Turn this button clockwise by one notch to increase frequency by 0.05MHz from current frequency.

Turn this button counterclockwise by one notch to decrease frequency by 0.05MHz from current frequency.

Type A

Turns to AUDIO CONTROL mode, and toggles in the order of BASS→MIDDLE→TREBLE→FADER→BALANCE→AVC ON→...BASS... when the button is pressed each time.

Type B

Turns to AUDIO CONTROL mode, and toggles in the order of BASS→MIDDLE→TREBLE→FADER→BALANCE→AVC→P.BASS→BASS... when the button is pressed each time.

6. Preset Button

Push [1]~[6]button less than 0.8 second to play the channel saved in each button. Push preset button for 0.8 second or longer to save current channel to the respective button with a beep.

7. CD/AUX Selection Button

If there is a CD in the CDP DECK it turns to CD mode, and if a device is connected to AUX then it toggles.

CD→AUX→CD... when the button is pressed each time.(It will not turn to AUX if the auxiliary device is not connected.)

CD (SA710) (IF EQUIPPED)



A-100FD

1. CD loading slot

Please face printed side upward and gently push in.

When the ignition switch is on ACC or ON and power is OFF, power is automatically turned on if the CD is loaded.

This CDP supports both 8cm and 12cm CDs. But if VCD, Data CD, MP3 CD are loaded, "Disc-Err" message will appear and CD will be ejected.

2. CD Eject Button

Push ▲ button to eject the CD during CD playback.

This button is enabled when ignition switch is off.

3. AUX Selection Button

If the auxiliary device is connected, it turns to AUX MODE to play the sound from the auxiliary player.

If no Disc and auxiliary device is connected, it displays "NO Media" for 5 seconds and returns to the previous mode.

4. SCAN Play Button

Play first 10 seconds of each song in the DISC.

To cancel the mode, press the key once again.

5. Automatic Track Selection Button

- Push [SEEK √] button for less than 0.8 second to play from the beginning of current song.
- Push [SEEK √] button for less than 0.8 second and press again within 1 second to play the previous song.
- Push [SEEK √] button for 0.8 second or longer to initiate reverse direction high speed sound search of current song.
- Push [SEEK ^] button for less than 0.8 second to play the next song.
- Push [SEEK ^] button for less than 0.8 second or longer to initiate high speed sound search of current song.

6. CD Indicator

When car ignition switch is ACC or ON and if the CD is loaded, this indicator is lighted.

If the CD is ejected the light is turned off.

7. REPEAT Button

Repeats current song when the button is pressed for less than 0.8 second.

Repeats the entire DISC when the button is pressed for 0.8 second or longer.

8. RANDOM Play Button

Turns ON/OFF the randomization of the play list of files in the currently played DISC.

To cancel the mode, press the key once again.

RADIO, SET UP, VOLUME CONTROL (PA710) (IF EQUIPPED)



- 1. FM Selection Button
- 2. AM Selection Button
- 3. CD Selection Button
- 4. AUX Selection Button
- 5. Automatic Channel Selection Button
- 6. Power ON/OFF & VOLUME Control Button
- 7. AUTO STORE Button
- 8. Screen ON/ OFF Button
- 9. Information Display Button
- 10. SET UP Button
- 11. TUNE/ENTER Button
- 12. Preset Button

1. FM Selection Button

Turns to FM mode and toggles FM1 and FM2 when the button is pressed each time.

2. AM Selection Button

Turns to AM mode, and toggles in the order of AM1→AM2→AM1... when the button is pressed each time.

3. CD Selection Button

If there is a cd in the CDP DECK it plays the CD.

Press CD button to automatically insert CD when the disc is ejected from the deck by pressing CD EJECT.

4. AUX Selection Button

If the auxiliary device is connected, it turns to AUX MODE to play the sound from the auxiliary player.

If no Disc and auxiliary device is connected, it displays "NO Media" for 5 seconds and returns to the previous mode.

5. Automatic Channel Selection Button

- When the [SEEK ∇] button is pressed, it reduces the band frequency by 100khz to automatically select channel. Stops at the previous frequency if no channel is found.
- When the [SEEK \wedge] button is pressed, it increases the band frequency by 100khz to automatically select channel. Stops at the previous frequency if no channel is found.

6. Power ON/OFF & Volume Control Button

- Turns on/off the set when the IGNITION SWITCH is on ACC or ON. If the button is turned to the right, it increases the volume and left, decreases the volume.
- In AUX mode, the volume and tone (BASS, MID, TRE) are adjusted in a separate way.
If you pull out AUX from a jack and insert it again, then only volume goes back to step 10.

7. AUTO STORE Button

When the button is pressed, it automatically selects and saves channels with high reception rate to PRESET buttons (1~6) and plays the channel saved in PRESET1.

If no channel is saved after AST, it will play the previous channel.

8. Screen ON/ OFF Button

Turns off/on the displayed data and light on LCD.

The screen and light will be turned on by pressing any button except DARK button when the screen is turned off.

9. Information Display Button

Type A

Displays the information of the channel currently played by RDS.

Type B

Displays the information of the channel currently played.

10. SET UP Button

Press this button to turn to the SOUND, clock setting, time display, SCROLL, SDVC, temperature display and adjustment mode.

If no action is taken for 5 seconds after pressing the button, it will return to the play mode. (After entering SET UP mode, move between items using the left, right and PUSH functions of the TUNE button.)

Type A

The set up item changes from SOUND → CLOCK → TIME → SCROLL → SDVC → TEMP → SOUND...

Type B

The set up item changes from AUDIO → CLOCK → TIME → SCROLL → SDVC → TEMP → P.BASS → AUDIO

11. TUNE/ENTER Button

Turn this button clockwise by one notch to increase frequency by 0.05Mhz from current frequency.

Turn this button counterclockwise by one notch to decrease frequency by 0.05Mhz from current frequency.

Press this button while holding SET UP button to activate / inactivate the item to. Select SET UP item using left and right function of the Tune button.

12. Preset Button

Push [1]~[6] buttons less than 0.8 second to play the channel saved in each button.

Push preset button for 0.8 second or longer to save current channel to the respective button with a beep.

CD (PA710) (IF EQUIPPED)



1. CD loading slot
2. CD indicator
3. CD Eject Button
4. AUX Selection Button
5. Automatic Track Selection Button
6. INFO Button
7. TUNE/ENTER Button
8. REPEAT Button
9. RANDOM Play Button
10. SCAN Play Button
11. FOLDER Moving Button

A-200FDD

1. CD loading slot

Please face printed side upward and gently push in. When the ignition switch is on ACC or ON and power is off, power is automatically turned on if the CD is loaded. This CDP supports both 8cm and 12 cm CDs. But if VCD, Data CD, MP3 CD are loaded, "Er-6" message will appear and CD will be ejected.

2. CD Indicator

When car ignition switch is ACC or ON and if the CD is loaded, this indicator is lighted. If the CD is ejected the light is turned off.

3. CD eject Button

Push ▲ button to eject the CD during CD playback. This button is enabled when ignition switch is off.

4. AUX Selection Button

If the auxiliary device is connected, it turns to AUX MODE to play the sound from the auxiliary player.

If no Disc and auxiliary device is connected, it displays "NO Media" for 5 seconds and returns to the previous mode.

5. Automatic Track Selection Button

- Push [SEEK ∨] button for less than 0.8 second to play from the beginning of current song.
- Push [SEEK ∨] button for less than 0.8 second and press again within 1 second to play the previous song.
- Push [SEEK ∨] button for 0.8 second or longer to initiate reverse direction high speed sound search of current song.
- Push [SEEK ^] button for less than 0.8 second to play the next song.
- Push [SEEK ^] button for 0.8 second or longer to initiate high speed sound search of current song.

6. INFO Button

Displays the information of the current CD TRACK in the order of DISC TITLE→DISC ARTIST→TRACK TITLE→TRACK ARTIST→TOTAL TRACK→ Play Screen→DISC TITLE→... (not displayed if the information is not available on the DISC.)

(If MP3 is displayed FILE NAME →TITLE →ARTIST→ALBUM→FOLDER→TOTAL FILE→FILE NAME→...)

7. TUNE/ENTER Button

Turn this button clockwise to display songs after current song.

Also, turn this button counterclockwise to display songs before current song.

To listen to the displayed song, press the button to skip to the song and play.

8. REPEAT Button

Repeats current song when the button is pressed for less than 0.8 second.

Repeats the entire DISC when the button is pressed for 0.8 second or longer.

9. RANDOM Play Button

Turns on/off the randomization of the play list of files in the currently played DISC.

To cancel the mode, press the key once again.

10. SCAN Play Button

Plays first 10 seconds of each song in the DISC.

To cancel the mode, press the key once again.

11. FOLDER Moving Button

- Moves [FLDR ∨] button child folder of the current folder and displays the first song in the folder. Press TUNE/ENTER button to move to the folder displayed. It will play the first song in the folder.
- Moves [FLDR ∧] button parent folder and displays the first song in the folder. Press TUNE/ENTER button to move to the folder displayed. It will play the first song in the folder.

USING USB (PA710) (IF EQUIPPED)



A-200FDD

In case USB is connected to the multi media jack inside the console on the left hand side of the driver's seat. When USB is connected, the 'USB' icon will be displayed on the top right corner of the display screen.

1. AUX Selection Button

If USB is not connected, it switches to the USB mode from the Radio and CD mode to play the song files stored in the USB. If AUX is not connected, it is invalid key.

2. Track Moving Button

- Press the [SEEK ∨] button for less than 0.8 second to play from the beginning of the song currently played. Press the button for less than 0.8 second and press it again within 1 second to move to and play the previous track. Press the button for 0.8 second or longer to play the song in reverse direction in fast speed.
- Press the [SEEK ^] button for less than 0.8 second to move to the next track. Press the button for 0.8 second or longer to play the song in forward direction in fast speed.

3. INFO Button

Displays the information of the file currently played in the order of FILE NAME → TITLE → ARTIST → ALBUM → FOLDER → TOTAL FILE → FILE NAME → ... (Displays no information if the file has no song information.)

4. Folder moving Button

- Moves [FLDR ∨] button child folder of the current folder and displays the first song in the folder. Press TUNE/ENTER button to move to the folder displayed. It will play the first song in the folder.
- Moves [FLDR ^] button parent folder and displays the first song in the folder. Press TUNE/ENTER button to move to the folder displayed. It will play the first song in the folder.

5. TUNE/ENTER Button

Turn this button clockwise to display the songs next to the currently played song. Turn the button counterclockwise to display the songs before the currently played song. Press the button to skip to and play the selected song.

6. RANDOM Playback Button

Press the button for less than 0.8 second to start or stop the random playback of the songs in the current folder.

Press the button for more than 0.8 second to randomly play the entire songs in the USB device.

Press the button again to cancel the mode.

7. REPEAT Button

Press the button for less than 0.8 second to repeat the song currently played.

Press the button for more than 0.8 second to repeat the entire songs in the USB device.

8. SCAN Button

Plays 10 seconds of each song in the USB device.

Press the button once again to cancel scanning.

**⚠ CAUTION IN USING
USB DEVICE**

- *To use the external USB device, make sure the device is not mounted when starting up the vehicle and mount the device after starting up.*
- *If you start the vehicle when the USB device is mounted, it may damage the USB device. (USB is not ESA)*
- *If the vehicle is started up or turned off while the external USB device is connected, the external USB device may not work.*
- *It may not play inauthentic MP3 or WMA files.*
 - 1) *It can only play MP3 files with the compression rate between 8Kbps~320Kbps.*
 - 2) *It can only play WMA music files with the compression rate between 8Kbps~320Kbps.*
- *Take cautions for static electricity when mounting or dismounting the external USB device.*
- *An encoded MP3 player is not recognizable.*

(Continued)

(Continued)

- *Depending on the condition of the external USB device, the connected external USB device can be unrecognizable.*
- *When the VHAPTTL byte/sector setting of External USB devices is not either 512BYTE or 2048BYTE, then the device will not be recognized.*
- *Use only the USB device formatted to FAT 12/16/32.*
- *USB device without USB I/F authentication may not be recognizable.*
- *Make sure the USB connection terminal does not come in contact with human body or any object.*
- *If you repeat mounting or dismounting USB device in a short period of time, it may break the device.*
- *You might hear strange noise when mounting or dismounting a USB device.*

(Continued)

(Continued)

- *If you dismount the external USB device during playback in USB mode, the external USB device can be damaged or malfunction. Therefore, mount the external USB device when the engine is turned off or in another mode.*
- *Depending on the type and capacity of the external USB device or the type of the files stored in the device, there is a difference in the time taken for recognition of the device, but this is not a trouble and you only have to wait.*
- *Do not use the USB device for other purposes than playing music files.*
- *Use of USB accessories such as the recharger or heater using USB I/F may lower the performance or cause trouble.*
- *If you use devices such as the USB hub you purchased separately, the vehicle's audio system may not recognize the USB device. Connect the USB device directly to the multimedia terminal of the vehicle.*

(Continued)

(Continued)

- *If USB device is divided by logical drives, only the music files on the highest-priority drive are recognized by car audio.*
- *Devices such as MP3 Player/ Cellular phone/Digital camera those are not recognizable by standard USB I/F can be unrecognizable.*
- *USB devices other than standardized goods (METAL COVER TYPE USB) can be unrecognizable.*
- *USB flash memory reader (such as CF, SD, microSD, etc.) or external-HDD type devices can be unrecognizable.*
- *Music files protected by DRM (DIGITAL RIGHTS MANAGEMENT) are not recognizable.*
- *The data in the USB memory may be lost while using this AUDIO. It is recommended to back up important data on a personal storage device.*

(Continued)

(Continued)

- *Please avoid using USB memory products which can be used as key chains or cellular phone accessories as they could cause damage to the USB jack. Please make certain only to use plug type connector products as shown below.*



RUNNING iPod (PA710) (IF EQUIPPED)

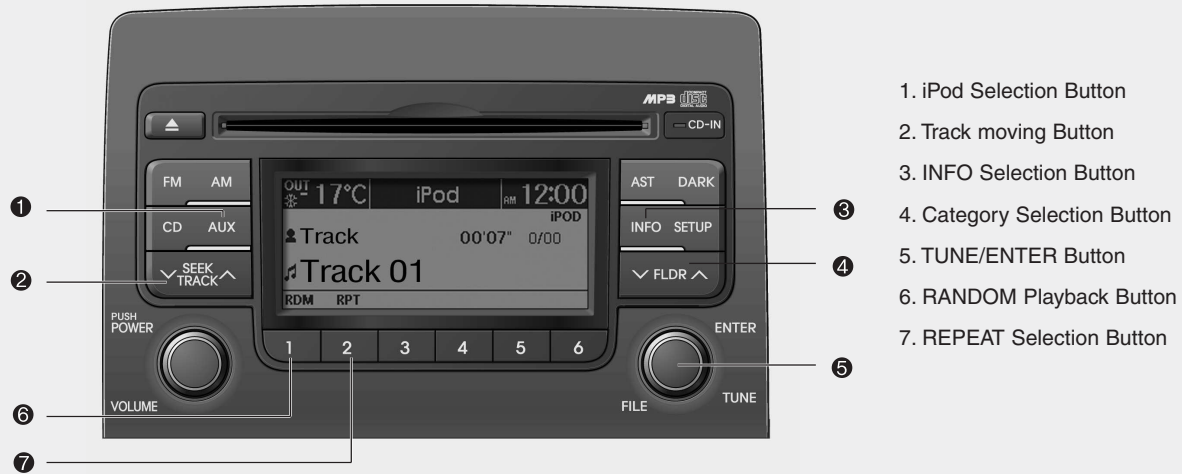

* iPod is a trademark of Apple Inc.

A-200FDD

In case the iPod exclusive cable is connected to the multimedia jack inside the console on the left hand side of the driver's seat. When the iPod is connected, the 'iPod' icon will be displayed on the top right corner of the display screen.

1. iPod Selection Button

If iPod is connected, it switches to the iPod mode from the Radio and CD mode to play the song files stored in the iPod. If there are no CD and AUX, it displays 'NO MEDIA'.

2. Track Moving Button

- Press the [SEEK ∨] button for less than 0.8 second to play from the beginning of the song currently played.
Press the button for less than 0.8 second and press it again within 1 second to move to and play the previous track. Press the button for 0.8 second or longer to play the song in reverse direction in fast speed.
- Press the [SEEK ∧] button for less than 0.8 second to move to the next track.
Press the button for 0.8 second or longer to play the song in forward direction in fast speed.

3. INFO Button

Displays the information of the file currently played in the order of FILE NAME → TITLE → ARTIST → ALBUM → FILE NAME → ...

(Displays no information if the file has no song information.)

4. Category Selection Button

Moves to the upper category from currently played category of the iPod.

You will be able to search through the lower category of the selected category.

The order of iPod's category is SONG, ALBUMS, ARTISTS, GENRES, and iPod. (Refer to the iPod user's manual for more information)

5. TUNE/ENTER Button

When you turn the button clockwise, it will display the songs (category) next to the song currently played (category in the same level).

Also, when you turn the button counter-clockwise, it will display the songs (category) before the song currently played (category in the same level).

If you want to listen to the song displayed in the song category, press the button, then it will skip to the selected song and play.

6. RANDOM Playback Button

Press the button for less than 0.8 second to activate or deactivate the random playback of the songs within the current category.

Press the button for longer than 0.8 second to randomly play all songs in the entire album of the iPod.

Press the button once again to cancel the mode.

7. REPEAT Button

Repeats the song currently played.

* NOTICE FOR USING iPod DEVICE

- Some iPod models might not support the communication protocol and the files will not be played. (iPod models supported: Mini, 4G, Photo, Nano, 5G)
- The order of search or playback of songs in the iPod can be different from the order searched in the audio system.
- If the iPod crashes due to its own trouble, reset iPod. (Reset: Refer to iPod manual)
- An iPod may not operate normally on low battery.

CAUTION IN USING iPod DEVICE

- *You need the power cable exclusive for iPod (purchased separately) in order to operate iPod with the buttons on the audio system. The PC cable provided by Apple may cause malfunction and do not use it for vehicle use.*
- *When connecting the device with an iPod cable, push in the jack fully not to interfere with communication.*
- *When adjusting the sound effects of iPod and the audio system, the sound effects of both devices will overlap each and might cause reduce or distort the quality of the sound.*
- *Deactivate (turn off) the equalizer function of iPod when adjusting the audio system's volume, and turn off the equalizer of the audio system when using the equalizer of iPod.*

(Continued)

(Continued)

- *When the iPod cable is connected, the system can be switched to the AUX mode even without the iPod device and can cause noise. Disconnect iPod cable when you are not using the iPod device.*
- *When the iPod is not used for the audio system, the iPod cable has to be separate from iPod devices. Original display of iPod may not be displayed.*

RADIO, SET UP, VOLUME CONTROL (PA760) (IF EQUIPPED)



1. FM Selection Button
2. AM Selection Button
3. CD Selection Button
4. AUX Selection Button
5. Automatic Channel Selection Button
6. Power ON/OFF & VOLUME Control Button
7. AUTO STORE Button
8. Screen ON/ OFF Button
9. Information Display Button
10. SET UP Button
11. TUNE/ENTER Button
12. Preset Button

A-300FDD

1. FM Selection Button

Turns to FM mode and toggles FM1 and FM2 when the button is pressed each time.

2. AM Selection Button

Turns to AM mode, and toggles in the order of AM1→AM2→AM1... when the button is pressed each time.

3. CD Selection Button

If there is a cd in the CDP DECK it plays the CD.

Press CD button to automatically insert CD when the disc is ejected from the deck by pressing CD EJECT.

4. AUX Selection Button

If the auxiliary device is connected, it turns to AUX MODE to play the sound from the auxiliary player.

If no Disc and auxiliary device is connected, it displays "NO Media" for 5 seconds and returns to the previous mode.

5. Automatic Channel Selection Button

- When the [SEEK ∇] button is pressed, it reduces the band frequency by 100khz to automatically select channel. Stops at the previous frequency if no channel is found.
- When the [SEEK \wedge] button is pressed, it increases the band frequency by 100khz to automatically select channel. Stops at the previous frequency if no channel is found.

6. Power ON/OFF & Volume Control Button

- Turns on/off the set when the IGNITION SWITCH is on ACC or ON. If the button is turned to the right, it increases the volume and left, decreases the volume.
- In AUX mode, the volume and tone (BASS, MID, TRE) are adjusted in a separate way.
If you pull out AUX from a jack and insert it again, then only volume goes back to step 10.

7. AUTO STORE Button

When the button is pressed, it automatically selects and saves channels with high reception rate to PRESET buttons (1~6) and plays the channel saved in PRESET1.

If no channel is saved after AST, it will play the previous channel.

8. Screen ON/ OFF Button

Turns off/on the displayed data and light on LCD.

The screen and light will be turned on by pressing any button except DARK button when the screen is turned off.

9. Information Display Button

Type A

Displays the information of the channel currently played by RDS.

Type B

Displays the information of the channel currently played.

10. SET UP Button

Press this button to turn to the SOUND, clock setting, time display, SCROLL, SDVC, temperature display and adjustment mode.

If no action is taken for 5 seconds after pressing the button, it will return to the play mode. (After entering SET UP mode, move between items using the left, right and PUSH functions of the TUNE button.)

Type A

The set up item changes from SOUND → CLOCK → TIME → SCROLL → SDVC → TEM → SOUND...

Type B

The set up item changes from AUDIO → CLOCK → TIME → SCROLL → SDVC → TEMP → AUDIO...

11. TUNE/ENTER Button

Turn this button clockwise by one notch to increase frequency by 0.05Mhz from current frequency.

Turn this button counterclockwise by one notch to decrease frequency by 0.05Mhz from current frequency.

Press this button while holding SET UP button to activate / inactivate the item to. Select SET UP item using left and right function of the Tune button.

12. Preset Button

Push [1]~[6] buttons less than 0.8 second to play the channel saved in each button.

Push preset button for 0.8 second or longer to save current channel to the respective button with a beep.

CD (PA760) (IF EQUIPPED)

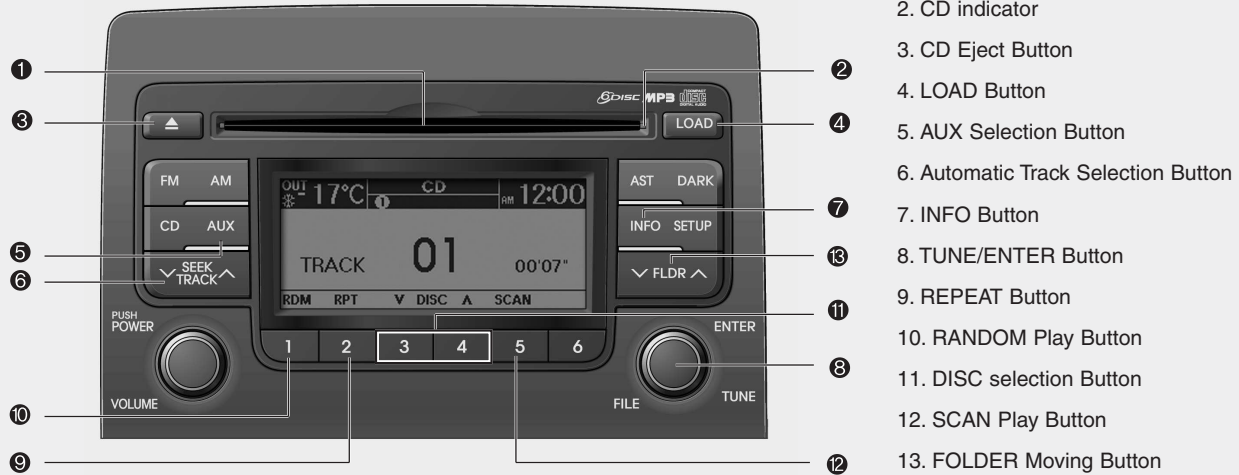

A-300FDD

1. CD loading slot

Please face printed side upward and gently push in. When the ignition switch is on ACC or ON and power is off, power is automatically turned on if the CD is loaded. This CDP supports both 8cm and 12 cm CDs. But if VCD, Data CD are loaded, "Er-6" message will appear and CD will be ejected.

2. CD Indicator

CD is loaded, this slot icon is displayed, If the CD is ejected the slot icon is display off.

3. CD eject Button

- Pressing the button for less than 0.8 second will eject 1 disc while pressing for 0.8 second ~ 3 seconds will eject all discs.
- Pressing the button for over 5 seconds will eject all discs by force. (EMERGENCY EJECT)

4. CD LOAD Button

Push [LOAD] button to load CDs to available CDC deck (from 1~6). Push [LOAD] button for more than 2 seconds to load into all available decks.

The last CD will play. 10 seconds idle status will disable loading process.

5. AUX Selection Button

If the auxiliary device is connected, it turns to AUX MODE to play the sound from the auxiliary player.

If no auxiliary device is connected, it displays "NO CONNECT" for 3 seconds and returns to the previous mode.

6. Automatic Track Selection Button

- Push [SEEK ∨] button for less than 0.8 second to play from the beginning of current song.
- Push [SEEK ∨] button for less than 0.8 second and press again within 3 seconds to play the previous song.
- Push [SEEK ∨] button for 0.8 second or longer to initiate reverse direction high speed sound search of current song.
- Push [SEEK ∧] button for less than 0.8 second to play the next song.
- Push [SEEK ∧] button for 0.8 second or longer to initiate high speed sound search of current song.

7. INFO Button

Displays the information of the current CD TRACK in the order of DISC TITLE→DISC ARTIST→TRACK TITLE→TRACK ARTIST→TOTAL TRACK→ Play Screen→DISC TITLE→... (not displayed if the information is not available on the DISC.)

(If MP3 is displayed FILE NAME →TITLE →ARTIST→ALBUM→FOLDER→TOTAL FILE→FILE NAME→...)

8. TUNE/ENTER Button

Turn this button clockwise to display songs after current song.

Also, turn this button counterclockwise to display songs before current song.

To listen to the displayed song, press the button to skip to the song and play.

9. REPEAT Button

Repeats current song when the button is pressed for less than 0.8 second.

Repeats the entire DISC when the button is pressed for 0.8 second or longer.

10. RANDOM Play Button

Turns on/off the randomization of the play list of files in the currently played DISC.

To cancel the mode, press the key once again.

11. DISC Selection Button

- [DISC ∨] Change Button
Changes disc to the previous disc.
- [DISC ^] Change Button
Changes disc to the next disc.

12. SCAN Play Button

Plays first 10 seconds of each song in the DISC.

To cancel the mode, press the key once again.

13. FOLDER Moving Button

- Moves [FLDR ∨] button child folder of the current folder and displays the first song in the folder. Press TUNE/ENTER button to move to the folder displayed. It will play the first song in the folder.
- Moves [FLDR ^] button parent folder and displays the first song in the folder. Press TUNE/ENTER button to move to the folder displayed. It will play the first song in the folder.

USING USB (PA760) (IF EQUIPPED)

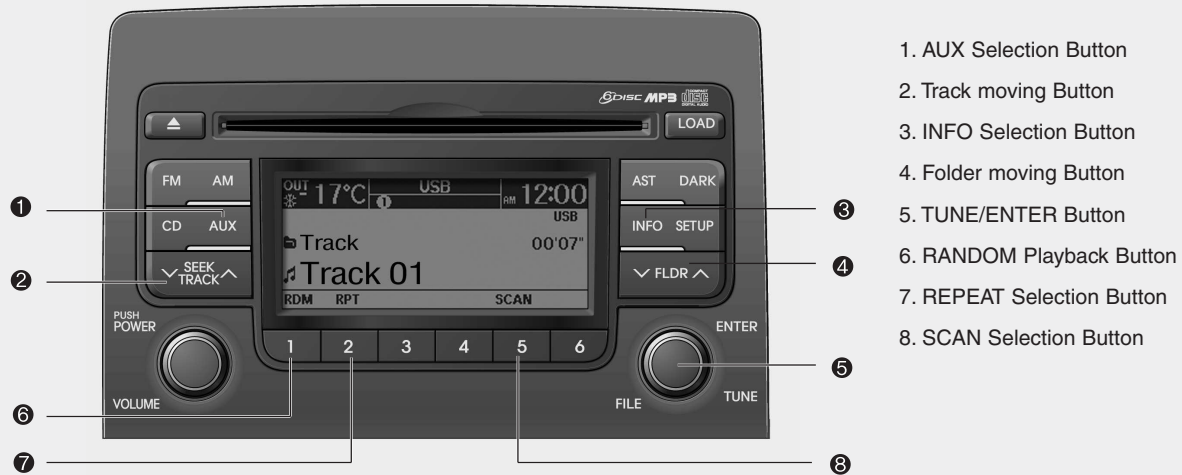

A-300FDD

In case USB is connected to the multi media jack inside the console on the left hand side of the driver's seat. When USB is connected, the 'USB' icon will be displayed on the top right corner of the display screen.

1. AUX Selection Button

If USB is not connected, it switches to the USB mode from the Radio and CD mode to play the song files stored in the USB. If AUX is not connected, it is invalid key.

2. Track Moving Button

- Press the [SEEK ∨] button for less than 0.8 second to play from the beginning of the song currently played. Press the button for less than 0.8 second and press it again within 1 second to move to and play the previous track. Press the button for 0.8 second or longer to play the song in reverse direction in fast speed.
- Press the [SEEK ^] button for less than 0.8 second to move to the next track. Press the button for 0.8 second or longer to play the song in forward direction in fast speed.

3. INFO Button

Displays the information of the file currently played in the order of FILE NAME → TITLE → ARTIST → ALBUM → FOLDER → TOTAL FILE → FILE NAME → ... (Displays no information if the file has no song information.)

4. Folder moving Button

- Moves [FLDR ∨] button child folder of the current folder and displays the first song in the folder. Press TUNE/ENTER button to move to the folder displayed. It will play the first song in the folder.
- Moves [FLDR ^] button parent folder and displays the first song in the folder. Press TUNE/ENTER button to move to the folder displayed. It will play the first song in the folder.

5. TUNE/ENTER Button

Turn this button clockwise to display the songs next to the currently played song. Turn the button counterclockwise to display the songs before the currently played song. Press the button to skip to and play the selected song.

6. RANDOM Playback Button

Press the button for less than 0.8 second to start or stop the random playback of the songs in the current folder.

Press the button for more than 0.8 second to randomly play the entire songs in the USB device.

Press the button again to cancel the mode.

7. REPEAT Button

Press the button for less than 0.8 second to repeat the song currently played.

Press the button for more than 0.8 second to repeat the entire songs in the USB device.

8. SCAN Button

Plays 10 seconds of each song in the USB device.

Press the button once again to cancel scanning.

CAUTION IN USING USB DEVICE

- To use the external USB device, make sure the device is not mounted when starting up the vehicle and mount the device after starting up.
- If you start the vehicle when the USB device is mounted, it may damage the USB device. (USB is not ESA)
- If the vehicle is started up or turned off while the external USB device is connected, the external USB device may not work.
- It may not play inauthentic MP3 or WMA files.
 - 1) It can only play MP3 files with the compression rate between 8Kbps~320Kbps.
 - 2) It can only play WMA music files with the compression rate between 8Kbps~320Kbps.
- Take cautions for static electricity when mounting or dismounting the external USB device.
- An encoded MP3 player is not recognizable.

(Continued)

(Continued)

- Depending on the condition of the external USB device, the connected external USB device can be unrecognizable.
- When the VHAPTTL byte/sector setting of External USB devices is not either 512BYTE or 2048BYTE, then the device will not be recognized.
- Use only the USB device formatted to FAT 12/16/32.
- USB device without USB I/F authentication may not be recognizable.
- Make sure the USB connection terminal does not come in contact with human body or any object.
- If you repeat mounting or dismounting USB device in a short period of time, it may break the device.
- You might hear strange noise when mounting or dismounting a USB device.

(Continued)

(Continued)

- If you dismount the external USB device during playback in USB mode, the external USB device can be damaged or malfunction. Therefore, mount the external USB device when the engine is turned off or in another mode.
- Depending on the type and capacity of the external USB device or the type of the files stored in the device, there is a difference in the time taken for recognition of the device, but this is not a trouble and you only have to wait.
- Do not use the USB device for other purposes than playing music files.
- Use of USB accessories such as the recharger or heater using USB I/F may lower the performance or cause trouble.
- If you use devices such as the USB hub you purchased separately, the vehicle's audio system may not recognize the USB device. Connect the USB device directly to the multimedia terminal of the vehicle.

(Continued)

(Continued)

- *If USB device is divided by logical drives, only the music files on the highest-priority drive are recognized by car audio.*
- *Devices such as MP3 Player/ Cellular phone/Digital camera those are not recognizable by standard USB I/F can be unrecognizable.*
- *USB devices other than standardized goods (METAL COVER TYPE USB) can be unrecognizable.*
- *USB flash memory reader (such as CF, SD, microSD, etc.) or external-HDD type devices can be unrecognizable.*
- *Music files protected by DRM (DIGITAL RIGHTS MANAGEMENT) are not recognizable.*
- *The data in the USB memory may be lost while using this AUDIO. It is recommended to back up important data on a personal storage device.*

(Continued)

(Continued)

- *Please avoid using USB memory products which can be used as key chains or cellular phone accessories as they could cause damage to the USB jack. Please make certain only to use plug type connector products as shown below.*



RUNNING iPod (PA760) (IF EQUIPPED)

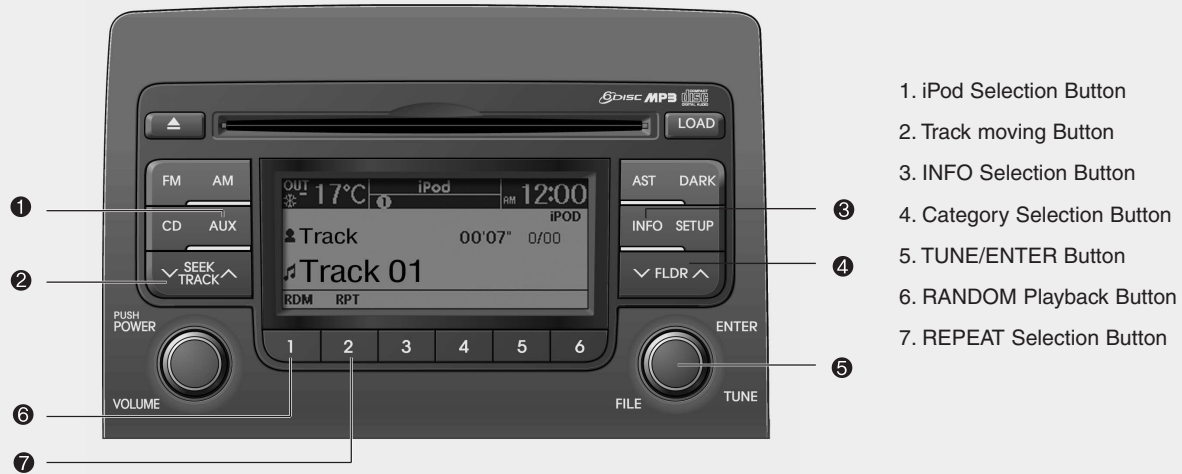

* iPod is a trademark of Apple Inc.

A-300FDD

In case the iPod exclusive cable is connected to the multimedia jack inside the console on the left hand side of the driver's seat. When the iPod is connected, the 'iPod' icon will be displayed on the top right corner of the display screen.

1. iPod Selection Button

If iPod is connected, it switches to the iPod mode from the Radio and CD mode to play the song files stored in the iPod. If there are no CD and AUX, it displays 'NO MEDIA'.

2. Track Moving Button

- Press the [SEEK ∨] button for less than 0.8 second to play from the beginning of the song currently played.
Press the button for less than 0.8 second and press it again within 1 second to move to and play the previous track. Press the button for 0.8 second or longer to play the song in reverse direction in fast speed.
- Press the [SEEK ∧] button for less than 0.8 second to move to the next track.
Press the button for 0.8 second or longer to play the song in forward direction in fast speed.

3. INFO Button

Displays the information of the file currently played in the order of FILE NAME → TITLE → ARTIST → ALBUM → FILE NAME → ...

(Displays no information if the file has no song information.)

4. Category Selection Button

Moves to the upper category from currently played category of the iPod.

You will be able to search through the lower category of the selected category.

The order of iPod's category is SONG, ALBUMS, ARTISTS, GENRES, and iPod. (Refer to the iPod user's manual for more information)

5. TUNE/ENTER Button

When you turn the button clockwise, it will display the songs (category) next to the song currently played (category in the same level).

Also, when you turn the button counter-clockwise, it will display the songs (category) before the song currently played (category in the same level).

If you want to listen to the song displayed in the song category, press the button, then it will skip to the selected song and play.

6. RANDOM Playback Button

Press the button for less than 0.8 second to activate or deactivate the random playback of the songs within the current category.

Press the button for longer than 0.8 second to randomly play all songs in the entire album of the iPod.

Press the button once again to cancel the mode.

7. REPEAT Button

Repeats the song currently played.

* NOTICE FOR USING iPod DEVICE

- Some iPod models might not support the communication protocol and the files will not be played. (iPod models supported: Mini, 4G, Photo, Nano, 5G)
- The order of search or playback of songs in the iPod can be different from the order searched in the audio system.
- If the iPod crashes due to its own trouble, reset iPod. (Reset: Refer to iPod manual)
- An iPod may not operate normally on low battery.

CAUTION IN USING iPod DEVICE

- *You need the power cable exclusive for iPod (purchased separately) in order to operate iPod with the buttons on the audio system. The PC cable provided by Apple may cause malfunction and do not use it for vehicle use.*
- *When connecting the device with an iPod cable, push in the jack fully not to interfere with communication.*
- *When adjusting the sound effects of iPod and the audio system, the sound effects of both devices will overlap each and might cause reduce or distort the quality of the sound.*
- *Deactivate (turn off) the equalizer function of iPod when adjusting the audio system's volume, and turn off the equalizer of the audio system when using the equalizer of iPod.*

(Continued)

(Continued)

- *When the iPod cable is connected, the system can be switched to the AUX mode even without the iPod device and can cause noise. Disconnect iPod cable when you are not using the iPod device.*
- *When the iPod is not used for the audio system, the iPod cable has to be separate from iPod devices. Original display of iPod may not be displayed.*